



KONICA MINOLTA

The essentials of imaging

# **bizhub 362/282/222**

## **User's Guide [Copy Operations]**

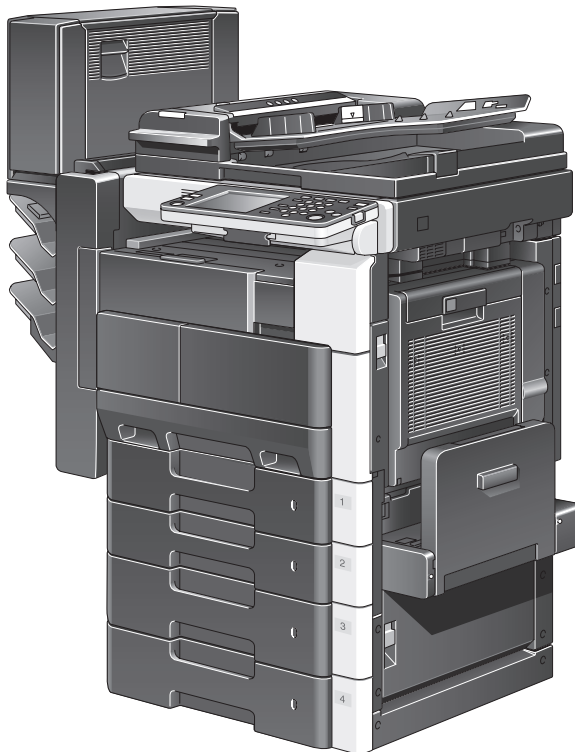

# Introduction

Thank you for choosing this machine.

This User's Guide contains details on the operation of the various functions of the bizhub 362, 282 and 222, precautions on its use, and basic troubleshooting procedures. In order to ensure that this machine is used correctly and efficiently, carefully read this User's Guide before using the machine. After reading the User's Guide, store it in the designated holder so that it can easily be referred to when questions or problems arise during operation.

Views of the actual equipment may be slightly different from the illustrations used in this User's Guide.

## Energy Star®



As an ENERGY STAR® Partner, we have determined that this machine meets the ENERGY STAR® Guidelines for energy efficiency.

### **What is an ENERGY STAR® Product?**

An ENERGY STAR® product has a special feature that allows it to automatically switch to a "low-power mode" after a period of inactivity. An ENERGY STAR® product uses energy more efficiently, saves you money on utility bills and helps protect the environment.

## Trademarks and registered trademarks

KONICA MINOLTA, KONICA MINOLTA Logo, and The essentials of imaging are registered trademarks or trademarks of KONICA MINOLTA HOLDINGS, INC.

PageScope and bizhub are registered trademarks or trademarks of KONICA MINOLTA BUSINESS TECHNOLOGIES, INC.

Netscape Communications, the Netscape Communications logo, Netscape Navigator, Netscape Communicator, and Netscape are trademarks of Netscape Communications Corporation.

Compact-VJE  
Copyright 1986-2003 VACS Corp.

RC4<sup>®</sup> is a registered trademark or trademark of RSA Security Inc. in the United States and/or other countries.

RSA<sup>®</sup> is a registered trademark or trademark of RSA Security Inc. RSA BSAFE<sup>®</sup> is a registered trademark or trademark of RSA Security Inc. in the United States and/or other countries.



License information

This product includes RSA BSAFE Cryptographic software from RSA Security Inc.

### OpenSSL Statement

#### *OpenSSL License*

Copyright © 1998-2000 The OpenSSL Project. All rights reserved. Redistribution and use in source and binary forms, with or without modification, are permitted provided that the following conditions are met:

1. Redistributions of source code must retain the above copyright notice, this list of conditions and the following disclaimer.
2. Redistributions in binary form must reproduce the above copyright notice, this list of conditions and the following disclaimer in the documentation and/or other materials provided with the distribution.
3. All advertising materials mentioning features or use of this software must display the following acknowledgment:  
 “This product includes software developed by the OpenSSL Project for use in the OpenSSL Toolkit. (<http://www.openssl.org/>)”

4. The names “OpenSSL Toolkit” and “OpenSSL Project” must not be used to endorse or promote products derived from this software without prior written permission. For written permission, please contact [openssl-core@openssl.org](mailto:openssl-core@openssl.org).
5. Products derived from this software may not be called “OpenSSL” nor may “OpenSSL” appear in their names without prior written permission of the OpenSSL Project.
6. Redistributions of any form whatsoever must retain the following acknowledgment:  
“This product includes software developed by the OpenSSL Project for use in the OpenSSL Toolkit (<http://www.openssl.org/>)”

THIS SOFTWARE IS PROVIDED BY THE OpenSSL PROJECT “AS IS” AND ANY EXPRESSED OR IMPLIED WARRANTIES, INCLUDING, BUT NOT LIMITED TO, THE IMPLIED WARRANTIES OF MERCHANTABILITY AND FITNESS FOR A PARTICULAR PURPOSE ARE DISCLAIMED. IN NO EVENT SHALL THE OpenSSL PROJECT OR ITS CONTRIBUTORS BE LIABLE FOR ANY DIRECT, INDIRECT, INCIDENTAL, SPECIAL, EXEMPLARY, OR CONSEQUENTIAL DAMAGES (INCLUDING, BUT NOT LIMITED TO, PROCUREMENT OF SUBSTITUTE GOODS OR SERVICES; LOSS OF USE, DATA, OR PROFITS; OR BUSINESS INTERRUPTION) HOWEVER CAUSED AND ON ANY THEORY OF LIABILITY, WHETHER IN CONTRACT, STRICT LIABILITY, OR TORT (INCLUDING NEGLIGENCE OR OTHERWISE) ARISING IN ANY WAY OUT OF THE USE OF THIS SOFTWARE, EVEN IF ADVISED OF THE POSSIBILITY OF SUCH DAMAGE.

This product includes cryptographic software written by Eric Young ([eay@cryptsoft.com](mailto:eay@cryptsoft.com)). This product includes software written by Tim Hudson ([tjh@cryptsoft.com](mailto:tjh@cryptsoft.com)).

#### *Original SSLLeay License*

Copyright © 1995-1998 Eric Young ([eay@cryptsoft.com](mailto:eay@cryptsoft.com)) All rights reserved. This package is an SSL implementation written by Eric Young ([eay@cryptsoft.com](mailto:eay@cryptsoft.com)).

The implementation was written so as to conform with Netscapes SSL. This library is free for commercial and non-commercial use as long as the following conditions are aheared to. The following conditions apply to all code found in this distribution, be it the RC4, RSA, lhash, DES, etc., code; not just the SSL code.

The SSL documentation included with this distribution is covered by the same copyright terms except that the holder is Tim Hudson ([tjh@cryptsoft.com](mailto:tjh@cryptsoft.com)).

Copyright remains Eric Young’s, and as such any Copyright notices in the code are not to be removed. If this package is used in a product, Eric Young should be given attribution as the author of the parts of the library used. This can be in the form of a textual message at program startup or in documentation (online or textual) provided with the package.



Redistribution and use in source and binary forms, with or without modification, are permitted provided that the following conditions are met:

1. Redistributions of source code must retain the copyright notice, this list of conditions and the following disclaimer.
2. Redistributions in binary form must reproduce the above copyright notice, this list of conditions and the following disclaimer in the documentation and/or other materials provided with the distribution.
3. All advertising materials mentioning features or use of this software must display the following acknowledgement:  
“This product includes cryptographic software written by Eric Young (eay@cryptsoft.com)”  
The word ‘cryptographic’ can be left out if the routines from the library being used are not cryptographic related.
4. If you include any Windows specific code (or a derivative thereof) from the apps directory (application code) you must include an acknowledgement:  
“This product includes software written by Tin Hudson (tjh@cryptsoft.com)”

THIS SOFTWARE IS PROVIDED BY ERIC YOUNG “AS IS” AND ANY EXPRESS OR IMPLIED WARRANTIES, INCLUDING, BUT NOT LIMITED TO, THE IMPLIED WARRANTIES OF MERCHANTABILITY AND FITNESS FOR A PARTICULAR PURPOSE ARE DISCLAIMED. IN NO EVENT SHALL THE AUTHOR OR CONTRIBUTORS BE LIABLE FOR ANY DIRECT, INDIRECT, INCIDENTAL, SPECIAL, EXEMPLARY, OR CONSEQUENTIAL DAMAGES (INCLUDING, BUT NOT LIMITED TO, PROCUREMENT OF SUBSTITUTE GOODS OR SERVICES; LOSS OF USE, DATA, OR PROFITS; OR BUSINESS INTERRUPTION) HOWEVER CAUSED AND ON ANY THEORY OF LIABILITY, WHETHER IN CONTRACT, STRICT LIABILITY, OR TORT (INCLUDING NEGLIGENCE OR OTHERWISE) ARISING IN ANY WAY OUT OF THE USE OF THIS SOFTWARE, EVEN IF ADVISED OF THE POSSIBILITY OF SUCH DAMAGE.

The licence and distribution terms for any publically available version or derivative of this code cannot be changed. i.e. this code cannot simply be copied and put under another distribution licence [including the GNU Public Licence.]

All other product names mentioned are trademarks or registered trademarks of their respective companies

# Contents

## Introduction

<b>Energy Star®</b> .....	<b>x-1</b>
What is an ENERGY STAR® Product? .....	x-1
<b>Trademarks and registered trademarks</b> .....	<b>x-2</b>
<b>Contents</b> .....	<b>x-5</b>
<b>Available features</b> .....	<b>x-16</b>
Automatically selecting the paper .....	x-16
Adjusting copies to the size of the paper .....	x-16
Specifying separate horizontal and vertical zoom ratios .....	x-16
Scanning the document in separate batches .....	x-16
Sorting copies .....	x-16
Stapling copies .....	x-17
Punching holes in copies .....	x-17
Center binding .....	x-17
Copying multiple document pages onto a single page .....	x-18
Copying a document containing pages of various sizes .....	x-18
Adjusting copies according to the image quality of the original ...	x-18
Adding a cover page .....	x-18
Adding insertions, such as colored paper, within copies .....	x-19
Inserting paper (interleaves) between copies of overhead projector transparencies .....	x-19
Adding a binding margin to copies .....	x-19
Erasing sections of copies .....	x-20
Repeating copy images .....	x-20
Separately copying a page spread .....	x-20
Copying with a layout of a book or magazine .....	x-20
Printing distribution numbers and stamps .....	x-21
Printing copies overlapping a different image .....	x-21
Copying with black and white reversed .....	x-21
Checking copy jobs .....	x-21
Programming copy settings .....	x-21
Checking the copy settings .....	x-21
Enlarging the size of text in touch panel screens .....	x-22
Interrupting a copy job .....	x-22
Printing a proof copy .....	x-22
Saving copy documents .....	x-22
<b>Explanation of manual conventions</b> .....	<b>x-23</b>
<b>User's Guides</b> .....	<b>x-25</b>
User's Guide [Copy Operations] (this manual) .....	x-25
User's Guide [Network Scanner Operations] .....	x-25
User's Guide [Box Operations] .....	x-25

User's Guide [Print Operations] .....	x-25
Quick Guide [Print Operations] .....	x-25
User's Guide [Advanced Scan Operations] .....	x-25
User's Guide [Facsimile Operations] .....	x-26
User's Guide [Fax Driver Operations] .....	x-26
<b>Descriptions and symbols for documents and paper .....</b>	<b>x-27</b>
"Width" and "Length" .....	x-27
Paper orientation .....	x-27
<b>Legal restrictions on copying .....</b>	<b>x-29</b>

## 1 Installation and operation precautions

<b>1.1 Safety information .....</b>	<b>1-2</b>
Warning and precaution symbols .....	1-2
Meaning of symbols .....	1-2
<b>1.2 USER INSTRUCTIONS .....</b>	<b>1-9</b>
FCC PART 15 - RADIO FREQUENCY DEVICES (For U.S.A. Users) .....	1-9
INTERFERENCE-CAUSING EQUIPMENT STANDARD (ICES-003 ISSUE 4) (For Canada Users) .....	1-9
For users in countries subject to Class B regulations .....	1-9
For users in countries not subject to Class B regulations .....	1-9
<b>1.3 Laser safety .....</b>	<b>1-10</b>
Internal laser radiation .....	1-10
CDRH regulation .....	1-11
For European users .....	1-11
For Denmark users .....	1-11
For Finland, Sweden users .....	1-12
For Norway users .....	1-12
Laser safety label .....	1-13
Ozone release .....	1-13
Acoustic noise (For European users only) .....	1-14
Notification for US only .....	1-14
Recycling batteries (For Taiwan Users Only) .....	1-14
For EU member states only .....	1-14
For EU member states only .....	1-15
<b>1.4 Caution notations and labels .....</b>	<b>1-16</b>
<b>1.5 Space requirements .....</b>	<b>1-17</b>
<b>1.6 Operation precautions .....</b>	<b>1-18</b>
Power source .....	1-18
Operating environment .....	1-18
Storage of copies .....	1-18

## 2 Before making copies

<b>2.1</b>	<b>Part names and their functions</b> .....	<b>2-2</b>
	Options .....	2-2
	Outside of machine .....	2-5
	Inside/back of main unit .....	2-7
	Reverse Automatic Document Feeder DF-620 .....	2-9
	Paper Feed Cabinet PC-108/PC-206/PC-407 .....	2-10
	Saddle Stitcher SD-507/Mailbin Kit MT-502 .....	2-11
	Finisher FS-530/Output Tray OT-602/Punch Unit PU-501 .....	2-12
	Control panel .....	2-14
	Basic settings screen (Basics screen) .....	2-17
	Icons that appear in the screen .....	2-18
	Enlarging the touch panel screens .....	2-19
<b>2.2</b>	<b>Adjusting the angle of the control panel</b> .....	<b>2-20</b>
	To adjust the angle of the control panel .....	2-20
<b>2.3</b>	<b>Turning on the main power and the auxiliary power</b> .....	<b>2-22</b>
	To turn on the machine .....	2-22
	To scan during warm-up .....	2-24
	To turn off the machine .....	2-26
	Automatically returning to the default settings (Automatic panel reset) .....	2-27
	Automatically returning to the screen given priority .....	2-27
	Automatically conserving energy (Low Power mode) .....	2-28
	Automatically conserving energy (Sleep mode) .....	2-28
	Darkening the touch panel (LCD Back-Light Off) .....	2-29
	Controlling machine use with user authentication (machine authentication) .....	2-30
	Controlling machine use with user authentication (external server authentication) .....	2-33
	Limiting user access with account track .....	2-37
	Controlling machine use with user authentication (external server authentication) and account track .....	2-40
	Controlling machine use with user authentication (machine authentication) and account track .....	2-45
	Controlling machine use with user authentication (machine authentication) and account track synchronized .....	2-50
<b>2.4</b>	<b>Loading paper into the 1st or 2nd tray</b> .....	<b>2-54</b>
	To load paper (1st or 2nd tray) .....	2-54
<b>2.5</b>	<b>Loading paper into the LCT</b> .....	<b>2-57</b>
	To load paper (LCT) .....	2-57
<b>2.6</b>	<b>Loading paper into the bypass tray</b> .....	<b>2-60</b>
	To load paper (bypass tray) .....	2-60

## 3 Basic copy operation

- 3.1 General copy operation .....3-2**
  - To make a copy .....3-2
- 3.2 Operations that cannot be combined .....3-5**
  - Operations where the setting specified last is given priority .....3-5
  - Operations where the setting specified first is given priority .....3-7
- 3.3 Feeding the document .....3-8**
  - To load the document into the ADF .....3-8
  - To place the document on the original glass .....3-10
  - Scanning a document in separate batches  
("Separate Scan" setting) .....3-12
  - Scanning a multi-page document from the original glass .....3-14
- 3.4 Specifying document settings .....3-16**
  - Copying documents of mixed sizes ("Mixed Original" setting) .....3-16
  - To copy documents with the "Mixed Original" setting .....3-16
  - Selecting the document orientation  
(Original Direction settings) .....3-19
  - To select an Original Direction setting .....3-20
  - Selecting the position of the binding margin (Margin settings) .....3-21
  - To select a Margin setting .....3-23
- 3.5 Selecting a Paper setting .....3-24**
  - Automatically selecting the paper size  
("Auto Paper Select" setting) .....3-24
  - Manually selecting the desired paper size .....3-25
- 3.6 Specifying a Zoom setting .....3-27**
  - Automatically selecting the zoom ratio ("Auto Zoom" setting) .....3-27
  - Specifying the same zoom ratio as the document  
("×1.0" setting) .....3-29
  - Slightly reducing the copy ("Minimal" setting) .....3-30
  - Finely adjusting the zoom ratio .....3-31
  - Selecting a preset zoom ratio (Enlarge and Reduce settings) .....3-32
  - Typing in the zoom ratio .....3-33
  - Specifying separate horizontal and vertical zoom ratios  
(Individual Zoom settings) .....3-34
  - Selecting a stored zoom ratio .....3-36
  - Storing the desired zoom ratio .....3-37
- 3.7 Selecting single-/double-sided settings for originals and copies .....3-39**
  - To select single-sided copies .....3-40
  - To select double-sided copies .....3-41
- 3.8 Specifying document quality/density settings .....3-43**
  - Specifying a document quality setting .....3-44

	Adjusting the Copy Density (Density settings) .....	3-45
<b>3.9</b>	<b>Selecting a Combine Originals setting</b> .....	<b>3-46</b>
	Copying multiple document pages onto a single page (combined copy settings) .....	3-49
<b>3.10</b>	<b>Selecting finishing for copies</b> .....	<b>3-50</b>
	Separating copies by sets (“Sort” setting) .....	3-53
	Separating copies by pages (“Group” setting) .....	3-54
	Stapling copies (staple settings) .....	3-55
	To bind copies with staples .....	3-56
	Punching holes in copies (punch settings) .....	3-57
	To punch holes in copies .....	3-57
	Binding copies at the center .....	3-59
	To bind copies at the center .....	3-59
<b>3.11</b>	<b>Scanning the next document during printing (reserving a copy job)</b> .....	<b>3-61</b>
	To reserve a copy job .....	3-61
<b>3.12</b>	<b>Stopping/deleting a job</b> .....	<b>3-63</b>
	To stop/delete a copy job .....	3-63
<b>4</b>	<b>Additional copy operations</b>	
<b>4.1</b>	<b>Checking the copy settings (Mode Check)</b> .....	<b>4-2</b>
	To check the settings .....	4-2
	To change the settings .....	4-4
<b>4.2</b>	<b>Printing a sample to check the settings (Proof Copy)</b> .....	<b>4-5</b>
	To make test prints .....	4-5
<b>4.3</b>	<b>Interrupting a copy job (Interrupt mode)</b> .....	<b>4-7</b>
	To interrupt a copy job .....	4-7
<b>4.4</b>	<b>Registering copy programs (Mode Memory)</b> .....	<b>4-8</b>
	To register a copy program .....	4-8
	To recall a copy program .....	4-10
	To checking the copy settings .....	4-11
	To delete a registered copy program .....	4-12
<b>4.5</b>	<b>Specifying control panel settings (Accessibility mode)</b> .....	<b>4-14</b>
	To display the Accessibility Settings screen .....	4-14
	To set the “Screen Mode” function .....	4-15
	To set the “Key Speed Settings” function .....	4-16
	To set the “Extend Auto Reset” function .....	4-17
	To set the “Notification Screen” function .....	4-18
	To set the “Sound Setting” function .....	4-19
	To set the “Key Sound Tones” function .....	4-20

<b>4.6</b>	<b>Job List screens</b> .....	<b>4-21</b>
	Jobs .....	4-21
	Multi-job feature .....	4-21
	Job List screens .....	4-21
<b>4.7</b>	<b>Performing operations on jobs</b> .....	<b>4-23</b>
	To check a job being performed .....	4-23
	To check the printing order .....	4-24
	To delete a job .....	4-25

## 5 Troubleshooting

<b>5.1</b>	<b>When the message “Malfunction detected.” appears (Call technical representative)</b> .....	<b>5-2</b>
	To correct the error .....	5-3
<b>5.2</b>	<b>When the message “Misfeed detected.” appears</b> .....	<b>5-4</b>
	Location of paper misfeed .....	5-4
	Paper misfeed indications .....	5-5
	To clear a paper misfeed in the ADF .....	5-6
	To clear a paper misfeed in the fusing unit .....	5-8
	To clear a paper misfeed in the automatic duplex unit .....	5-12
	To clear a paper misfeed in the bypass tray .....	5-13
	To clear a paper misfeed in the 1st or 2nd tray .....	5-15
	To clear a paper misfeed in the 3rd or 4th tray .....	5-17
	To clear a paper misfeed in the LCT .....	5-18
	To clear a paper misfeed in the finisher .....	5-19
	To clear a paper misfeed in the mailbin kit .....	5-22
	To clear a paper misfeed in the saddle stitcher .....	5-24
<b>5.3</b>	<b>When the message “Replenish paper.” appears</b> .....	<b>5-26</b>
	To replenish paper .....	5-26
<b>5.4</b>	<b>When the message “... Not enough remaining memory.” appears</b> .....	<b>5-27</b>
<b>5.5</b>	<b>When the message “Please exchange toner.” appears</b> .....	<b>5-28</b>
<b>5.6</b>	<b>When the message “Stapler empty.” appears</b> .....	<b>5-29</b>
<b>5.7</b>	<b>Basic troubleshooting</b> .....	<b>5-30</b>
<b>5.8</b>	<b>Main messages and their remedies</b> .....	<b>5-34</b>

## 6 Specifications

<b>6.1</b>	<b>Specifications</b> .....	<b>6-2</b>
	Copier .....	6-2
	Automatic Duplex Unit .....	6-4
	Reverse Automatic Document Feeder DF-620 .....	6-4
	Paper Feed Cabinet PC-108 .....	6-5

Paper Feed Cabinet PC-206 .....	6-6
Paper Feed Cabinet PC-407 .....	6-6
Finisher FS-530 .....	6-7
Punch Unit PU-501 .....	6-8
Saddle Stitcher SD-507 .....	6-8
Output Tray OT-602 .....	6-8
Mailbin Kit MT-502 .....	6-9
Job Separator JS-502 .....	6-9

## 7 Copy paper/original documents

<b>7.1 Copy paper .....</b>	<b>7-2</b>
Possible paper sizes .....	7-2
Paper types and paper capacities .....	7-4
Special paper .....	7-5
Precautions for paper .....	7-6
Paper storage .....	7-6
Automatic paper-tray-switching feature .....	7-7
Order for selecting the paper trays .....	7-7
<b>7.2 Specifying paper settings for the bypass tray .....</b>	<b>7-8</b>
To specify the paper size (Change Setting) .....	7-8
To specify a non-standard paper size (Custom Size settings) ....	7-10
To store a non-standard paper size (Custom Size settings) .....	7-12
To specify a setting for special paper (Change Setting) .....	7-15
<b>7.3 Original documents .....</b>	<b>7-17</b>
Documents that can be loaded into the ADF .....	7-17
Precautions for loading documents into the ADF .....	7-18
Documents that can be placed on the original glass .....	7-19
Precautions for positioning documents on the original glass .....	7-19

## 8 Application functions

<b>8.1 Adding cover pages (“Cover Mode” function) .....</b>	<b>8-2</b>
To copy using the “Cover Mode” function .....	8-3
<b>8.2 Inserting cover pages (“Insert Sheet” function) .....</b>	<b>8-5</b>
To copy using the “Insert Sheet” function .....	8-6
<b>8.3 Inserting paper between overhead projector transparencies (“OHP Interleave” function) .....</b>	<b>8-8</b>
To copy using the “OHP Interleave” function .....	8-8
<b>8.4 Adding filing margins to copies (“Page Margin” function) .....</b>	<b>8-11</b>
To copy using the “Page Margin” function .....	8-11



<b>8.5 Erasing unwanted areas of copies (“Edge/Frame Erase” function)</b>	<b>8-13</b>
To copy using the “Edge/Frame Erase” function	8-13
<b>8.6 Tiling copy images (“Image Repeat” function)</b>	<b>8-15</b>
To copy using the “Image Repeat” function	8-15
<b>8.7 Producing separate copies of each page in a page spread (“Book Copy” function)</b>	<b>8-18</b>
To copy using the “Book Copy” function	8-19
<b>8.8 Creating booklet copies (“Booklet” function)</b>	<b>8-22</b>
To copy using the “Booklet” function	8-23
<b>8.9 Printing additional information on copies (Image Settings functions)</b>	<b>8-24</b>
To print the distribution number (“Set Numbering” function)	8-24
To print preset text at the center of the copy image (“Stamp” function)	8-26
<b>8.10 Printing copies overlapping a different image (“Image Overlay” function)</b>	<b>8-28</b>
To store an overlay image (Store Overlay)	8-28
To recall an overlay image	8-31
To check the overlay image	8-33
<b>8.11 Copying with light and dark coloring inversed (“B/W Reverse” setting)</b>	<b>8-35</b>
To copy using the “B/W Reverse” setting	8-35
<b>8.12 Separate scan</b>	<b>8-36</b>
To scan documents continuously	8-36

## 9 Replacing toner bottles and staples and emptying punch waste containers

<b>9.1 Replacing the toner bottle</b>	<b>9-2</b>
To replace the toner bottle	9-4
<b>9.2 Replacing the staple cartridge</b>	<b>9-7</b>
To replace the staple cartridge in finisher	9-7
To replace the staple cartridge in saddle stitcher	9-10
<b>9.3 Clearing a staple jam</b>	<b>9-14</b>
To clear jammed staples in finisher	9-15
To clear jammed staples in the saddle stitcher	9-19
<b>9.4 Emptying the waste containers</b>	<b>9-24</b>
To empty the hole-punch waste container	9-24

## 10 Care of the machine

<b>10.1</b>	<b>Cleaning</b> .....	<b>10-2</b>
	Housing .....	10-2
	Original glass .....	10-3
	Control panel .....	10-4
	Document pad .....	10-5
	Left partition glass .....	10-5
<b>10.2</b>	<b>Viewing counters (Total Counter)</b> .....	<b>10-6</b>
	To view the contents .....	10-6
<b>10.3</b>	<b>When the message “Preventative Maintenance is required.” appears</b> .....	<b>10-7</b>

## 11 Utility mode

<b>11.1</b>	<b>Overview of Utility mode parameters</b> .....	<b>11-2</b>
	List of registration information and parameters .....	11-2
<b>11.2</b>	<b>Specifying User’s Choice settings</b> .....	<b>11-9</b>
	To specify User’s Choice settings .....	11-9
	Mixed Original Detection .....	11-10
	Language Selection .....	11-10
	Measurement Unit Setting .....	11-11
	Machine Authentication PW Change .....	11-11
	Default Setting Simplex/Duplex .....	11-11
	Auto Paper/Auto Zoom .....	11-11
	Priority Tray .....	11-12
	Special Paper Setting .....	11-12
	Zoom Ratio for Combine/Booklets .....	11-12
	Low Power Mode .....	11-13
	Sleep Mode .....	11-13
	LCD Back-Light OFF .....	11-13
	Auto Reset .....	11-13
	Auto Reset when Account is changed .....	11-14
	4in1 Copy Order .....	11-14
	Default Quality/Density Modes .....	11-14
	Default Copy Output Levels .....	11-14
	Print Density .....	11-15
	Default Finishing Mode .....	11-15
	Sort/Non-Sort Auto Change .....	11-15
	Output Tray Settings .....	11-16
	Auto Paper Select for Small Orig. ....	11-16
	Crease/Center Staple .....	11-17
	Default Screen .....	11-17
	Default Device .....	11-18
	Image Quality (ADF) .....	11-18

<b>11.3</b>	<b>Specifying User Management settings</b> .....	<b>11-19</b>
	To specify user management settings .....	11-19
	Tone volume parameters .....	11-20
	Panel Cleaning .....	11-20
	Toner Supply .....	11-20
<b>11.4</b>	<b>Displaying the Administrator Management screen</b> .....	<b>11-21</b>
	To display the Administrator Management screen .....	11-21
<b>11.5</b>	<b>Specifying Initial Settings</b> .....	<b>11-23</b>
	To specify initial settings .....	11-23
	Date & Time Setting .....	11-24
<b>11.6</b>	<b>Specifying Administrator settings</b> .....	<b>11-25</b>
	To specify administrator settings .....	11-25
	Administrator Code Input .....	11-26
	Max. Copy Sets .....	11-26
	Disable Sleep Mode .....	11-26
<b>11.7</b>	<b>Specifying the account/authentication settings (User Authentication ON/OFF parameters)</b> .....	<b>11-27</b>
	To specify the account/authentication settings .....	11-27
	User Authentication ON/OFF .....	11-29
	Allow Print without Authentication .....	11-29
<b>11.8</b>	<b>Specifying account data settings</b> .....	<b>11-31</b>
	To display the desired account .....	11-31
	To register an account .....	11-32
	To manage an account .....	11-34
	To delete an account .....	11-36
	Allowing printing without authentication .....	11-37
<b>11.9</b>	<b>Specifying user authentication settings</b> .....	<b>11-38</b>
	To display the User Authentication screen .....	11-38
	To register a user with external server authentication .....	11-40
	To register a user with machine authentication .....	11-42
	To manage a user for machine authentication .....	11-46
	To delete a user for machine authentication .....	11-48
<b>11.10</b>	<b>Specifying software switch settings (machine functions)</b> .....	<b>11-50</b>
	To specify a software switch setting .....	11-51
	Specifying permissions for copy functions (mode 307) .....	11-53
	Specifying the enlarged display method (mode 311) .....	11-53
	Specifying that the “Auto Paper Select” setting and the “Auto Zoom” setting can be selected at the same time (mode 403) .....	11-54
	Specifying the measurement units (mode 426) .....	11-55
	Specifying settings when copying is finished using the ADF (mode 429) .....	11-55

Specifying the pressing of the [Access] key when logging off (mode 438) .....	11-56
Specifying use of registered user authentication information to log on to the LDAP server (mode 466) .....	11-56
Specifying whether to enable access locks and password rules, and specifying the method for deleting image data (mode 469) .....	11-57
Specifying the setting for displaying a list of users in the User Authentication screen (mode 471) .....	11-59
Specifying the deleting method for [Del.] in input screens (mode 478) .....	11-59
Specifying settings for limiting user authentication to only Scan functions (mode 479) .....	11-60
<b>11.11 Specifying security settings (Security Setting parameters) .....</b>	<b>11-62</b>
Before specifying the “Enhance Security” parameter .....	11-62
Parameters that are changed when “Enhance Security” is set .....	11-63
Specifying the “Enhance Security” parameter .....	11-64
Canceling an access lock (“Unlock” parameter) .....	11-66
To cancel an access lock .....	11-66
<b>11.12 Managing the memory (Memory Management parameters) ....</b>	<b>11-68</b>
To erase all data from the internal memory .....	11-68
<b>11.13 Password rules .....</b>	<b>11-70</b>

## 12 Appendix

<b>12.1 Entering text .....</b>	<b>12-2</b>
To type text .....	12-2
List of available characters .....	12-3
<b>12.2 Glossary .....</b>	<b>12-4</b>
<b>12.3 Index .....</b>	<b>12-7</b>

## Available features

### Automatically selecting the paper

The most appropriate paper size can automatically be selected based on the size of the loaded document and the specified zoom ratio.

For details, refer to page 3-24.

### Adjusting copies to the size of the paper

The most appropriate zoom ratio can automatically be selected based on the size of the loaded document and the specified paper size.

For details, refer to page 3-27.

### Specifying separate horizontal and vertical zoom ratios

By specifying separate horizontal and vertical zoom ratios, copies of the document can be resized as desired.

For details, refer to page 3-34.

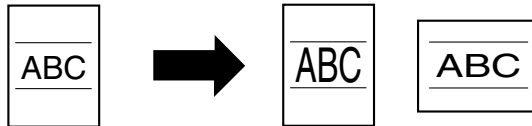

### Scanning the document in separate batches

A document with a large number of pages can be divided and scanned together in separate batches. Double-sided copies can be produced by using the original glass, or the document pages can be loaded alternately onto the original glass and into the ADF, and then all pages can be printed together as a single job.

For details, refer to page 3-12 and page 3-14.

### Sorting copies

A method for sorting the copies can be selected.



For details, refer to page 3-53 and page 3-54.

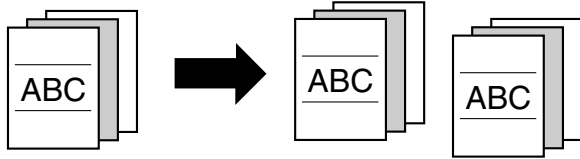

**Stapling copies**

Copies can be stapled together.

For details, refer to page 3-55.

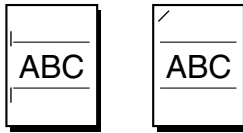

**Punching holes in copies**

Holes for filing can be punched in the copies.

For details, refer to page 3-57.

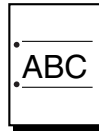

**Center binding**

Copies can be folded at their center and bound with staples.

For details, refer to page 3-59.

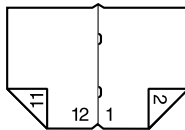

### Copying multiple document pages onto a single page

Multiple pages of the document can be printed together on a single copy.

For details, refer to page 3-46.

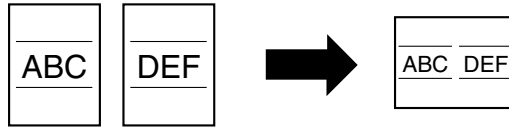

### Copying a document containing pages of various sizes

A document with pages of various sizes can be scanned and copied together.

For details, refer to page 3-16.

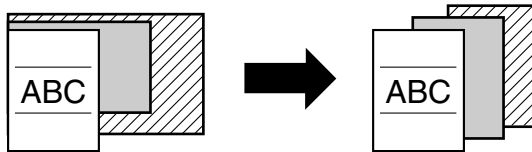

### Adjusting copies according to the image quality of the original

The copies can be adjusted according to the image quality of the document.

For details, refer to page 3-43.

### Adding a cover page

Cover pages can be added to copies.

For details, refer to page 8-2.

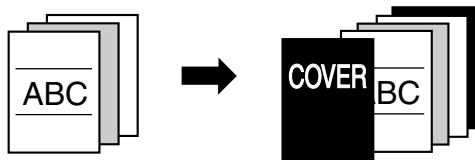



### Adding insertions, such as colored paper, within copies

Different paper (such as colored paper) can be inserted at specified locations in the copies.

For details, refer to page 8-5.

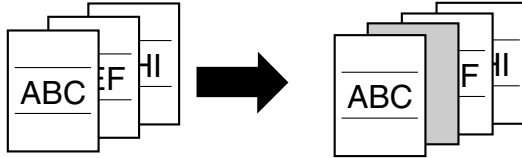

### Inserting paper (interleaves) between copies of overhead projector transparencies

After each overhead projector transparency copy is printed, a page can be added to the stack as an interleaf.

For details, refer to page 8-8.

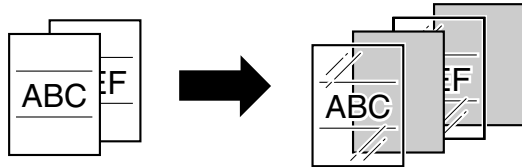

### Adding a binding margin to copies

Copies can be printed with a filing margin so they can easily be stored in filing binders.

For details, refer to page 8-11.

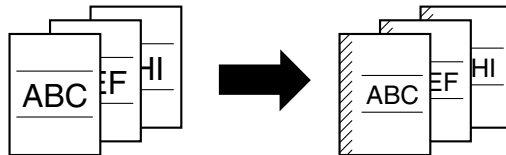



### Erasing sections of copies

Areas, such as the shadows of punched holes and transmission information in received faxes, can be erased in copies.

For details, refer to page 8-13.

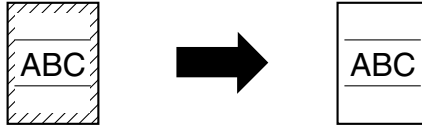

### Repeating copy images

A document image can be repeatedly printed on a single sheet of paper.

For details, refer to page 8-15.

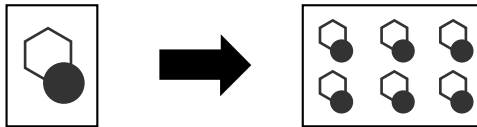

### Separately copying a page spread

A page spread, such as in an open book or catalog, can be copied onto separate pages.

For details, refer to page 8-18.

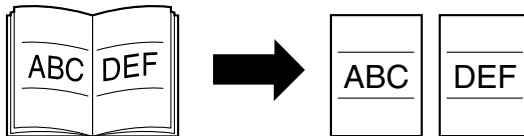

### Copying with a layout of a book or magazine

Copies can be made with the pages arranged in the layout for a book or magazine.

For details, refer to page 8-22.

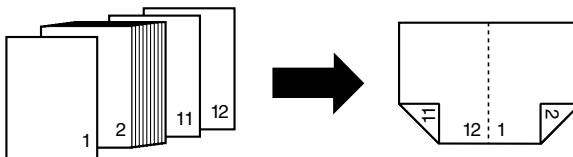

### Printing distribution numbers and stamps

Each copy set can be printed with distribution numbers or preset stamps. For details, refer to page 8-24.

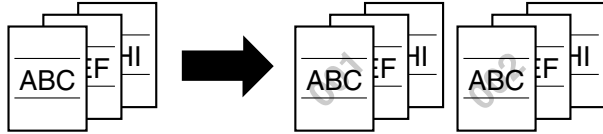

### Printing copies overlapping a different image

Previously stored images can be printed overlapping copies. For details, refer to page 8-28.

### Copying with black and white reversed

A document can be copied with the black- and white-colored areas of images inverted.

For details, refer to page 8-35.

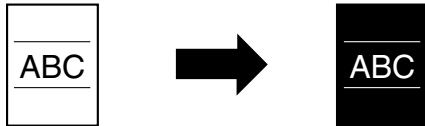

### Checking copy jobs

The status of queued jobs can be checked.

For details, refer to page 4-21.

### Programming copy settings

Frequently used copy settings can be programmed and recalled to be used with other copy jobs.

For details, refer to page 4-8.

### Checking the copy settings

Screens showing the current copy settings can be displayed. From these screens, the copy settings can also be changed.

For details, refer to page 4-2.

**Enlarging the size of text in touch panel screens**

The text and buttons in the touch panel can be displayed in a larger size that is easier to read, allowing basic copy operations to be easily performed.

For details, refer to page 2-19.

**Interrupting a copy job**

The copy job being printed can be interrupted in order for a different copy job to be printed.

For details, refer to page 4-7.

**Printing a proof copy**

Before printing a large number of copies, a single proof copy can be printed so that it can be checked.

For details, refer to page 4-5.

**Saving copy documents**

If the optional hard disk drive is installed, the contents of documents can be saved in boxes.

For details, refer to the User's Guide [Box Operations].

# Explanation of manual conventions

Titles indicate the contents of the section.

Text that appears in this manner describes the function limitations and options required to use certain functions.

[ ] Names highlighted as shown above indicate keys on the control panel, buttons in the touch panel, and the power switches.

Touch panel screens are shown to check the actual display.

Text that appears in this manner describes supplemental information, such as precautions, references and actions, relating to steps.

Text that appears in this manner provides answers to problems and questions that may occur during operation.

Auxiliary functions

**Chapter 8**

**8.10 Printing copies overlapping a different image ("Image Overlay" function)**

Images previously stored on the hard disk can be printed overlapping copies.

**To store an overlay image (Store Overlay)**

- ✓ The "Image Overlay" function is available only if optional hard disk HD-504 is installed.

- 1 Position the overlay document to be stored on the hard disk.
- 2 Press the [Utility/Counter] key, and then touch [User Setting]. The User Setting screen appears.



**CAUTION**

**Handling toner and toner bottles**

- Do not throw toner or the toner bottle into a fire.
- Toner expelled from the fire may cause burns.

- 3 Select the size of the area to be scanned.
  - To cancel changes to the settings, touch [Cancel].
  - What do the Book Erase settings do?
    - If a Book Erase setting is selected, the dark shadows around the document or along the center of the document can be erased.
- 4 Touch [Enter].



8-30

## WARNING , CAUTION

Text highlighted in this manner indicates precautions to ensure safe use of this machine. "Warning" indicates instructions that, when not observed, may result in fatal or critical injuries. "Caution" indicates instructions that, when not observed, may result in serious injuries or property damage.

(The page shown above is an example only.)

**Auxiliary functions** 8

5 Select the document orientation.  
 - To cancel changes to the settings, touch [Cancel].



6 Press the [Start] key.  
 The document is scanned, and the overlay image is stored.

**Reminder**  
*Be sure to use toner bottles of the specified model, otherwise the machine may be damaged.*

**Note**  
*The size of the scanned area appears on the button where the image is stored.*

**Detail**  
*For details on replacing the toner bottle, refer to "To replace the toner bottle" on page 3-4.*

8-31

**Chapter 8**  
 Auxiliary functions

**Reminder**  
 Text highlighted in this manner indicates operation precautions. Carefully read and observe this type of information.

**Detail**  
 Text highlighted in this manner provides more detailed information concerning operating procedures or references to sections containing additional information. If necessary, refer to the indicated sections.

**Note**  
 Text highlighted in this manner contains references and supplemental information concerning operating procedures and other descriptions. We recommend that this information be read carefully.

(The page shown above is an example only.)



## User's Guides

The following User's Guides have been prepared for this machine.

### **User's Guide [Copy Operations] (this manual)**

This manual contains details on basic operations and the operating procedures for the various copy functions.

- Refer to this User's Guide for details on operating procedures for copy functions, including precautions on installation/use, turning the machine on/off, loading paper, and troubleshooting operations such as clearing paper misfeeds.

### **User's Guide [Network Scanner Operations]**

This manual contains details on specifying network functions for standard equipment and on operations for scanning functions.

- Refer to this User's Guide for details on operating procedures for network functions and for using the Scan to E-Mail, Scan to FTP, Scan to SMB and Internet fax operations.

### **User's Guide [Box Operations]**

This manual contains details on operating procedures for using the Box functions.

- Refer to this User's Guide for details on printing a proof copy or a locked job and on functions that use the optional hard disk drive, such as routing and saving documents in boxes.

### **User's Guide [Print Operations]**

This manual contains details on operating procedures using the standard built-in printer controller.

- For details on the printing functions, refer to the User's Guide (PDF file) on the Driver CD-ROM.

### **Quick Guide [Print Operations]**

This manual contains details on operating procedures using the standard built-in printer controller.

- Refer to this Quick Guide for basic operating procedures on the printing functions.

### **User's Guide [Advanced Scan Operations]**

This manual contains details on the operating procedures for the functions that can be used when the optional scanner unit is installed.

- Refer to this User's Guide for details on using the IP address faxing, IP Relay and Scan to PC operations and on using IP Scanner.

**User's Guide [Facsimile Operations]**

This manual contains details on operating procedures for using the Fax functions.

- Refer to this User's Guide for details on operating procedures for the Fax functions when the fax kit is installed.

**User's Guide [Fax Driver Operations]**

This manual contains function details on the fax driver, which is used to send faxes directly from a computer.

- Refer to the User's Guide (PDF file) on the Driver CD-ROM for details on procedures for performing PC-FAX operations.

## Descriptions and symbols for documents and paper

The use of words and symbols in this manual are explained below.

### “Width” and “Length”

Whenever paper dimensions are mentioned in this manual, the first value always refers to the width of the paper (shown as “Y” in the illustration) and the second to the length (shown as “X”).

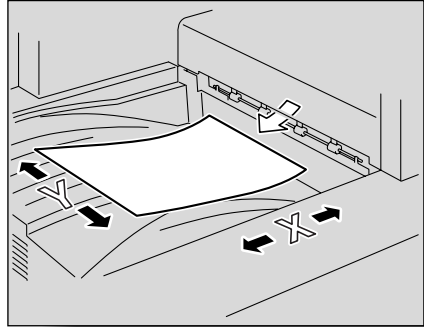

### Paper orientation

Lengthwise (☐)

If the width (Y) of the paper is shorter than the length (X), the paper has a vertical or portrait orientation, indicated by ☐.

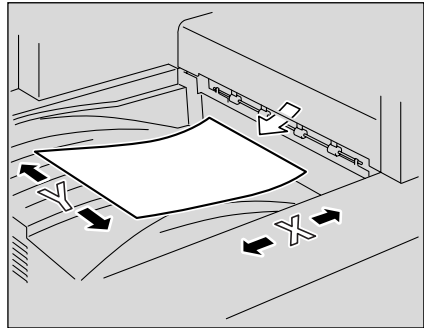



**Crosswise (L)**

If the width (Y) of the paper is longer than the length (X), the paper has a horizontal or landscape orientation, indicated by L.

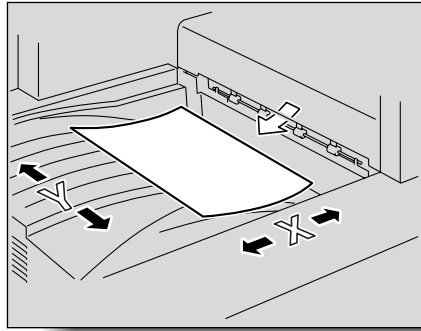



## Legal restrictions on copying

Certain types of documents must never be copied with the purpose or intent to pass copies of such documents off as the originals.

The following is not a complete list, but is meant to be used as a guide to responsible copying.

### <Financial instruments>

- Personal checks
- Traveler's checks
- Money orders
- Certificates of deposit
- Bonds or other certificates of indebtedness
- Stock certificates

### <Legal documents>

- Food stamps
- Postage stamps (canceled or uncanceled)
- Checks or drafts drawn by government agencies
- Internal revenue stamps (canceled or uncanceled)
- Passports
- Immigration papers
- Motor vehicle licenses and titles
- House and property titles and deeds

### <General>

- Identification cards, badges, or insignias
- Copyrighted works without permission of the copyright owner

In addition, it is prohibited under any circumstances to copy domestic or foreign currencies, or works of art without permission of the copyright owner.

When in doubt about the nature of a document, consult with legal counsel.



---



# **Installation and operation precautions**

# 1 Installation and operation precautions

## 1.1 Safety information

This section contains detailed instructions on the operation and maintenance of this machine. To achieve optimum utility of this device, all operators should carefully read and follow the instructions in this manual.

Please read the following section before connecting the machine to the supply. It contains important information related to user safety and preventing equipment problems.

Please keep this manual in a handy place near the machine.

Make sure you observe all of the precautions appear in each section of this manual.

KM\_Ver.02E





### Note

*Some parts of the contents of this section may not correspond with the purchased product.*

### Warning and precaution symbols

The following indicators are used on the warning labels or in this manual to categorize the level of safety warnings.

 <b>WARNING</b>	Ignoring this warning could cause serious injury or even death.
 <b>CAUTION</b>	Ignoring this caution could cause injury or damage to property.

### Meaning of symbols



A triangle indicates a danger against which you should take precaution.



This symbol warns against cause burns.



A diagonal line indicates a prohibited course of action.



This symbol warns against dismantling the device.





A solid circle indicates an imperative course of action.





This symbol indicates you must unplug the device.

**Disassemble and modification****⚠ WARNING**

- Do not attempt to remove the covers and panels which have been fixed to the product. Some products have a high-voltage part or a laser beam source inside that could cause an electrical shock or blindness. 
- Do not modify this product, as a fire, electrical shock, or breakdown could result. If the product employs a laser, the laser beam source could cause blindness. 

**Power cord****⚠ WARNING**

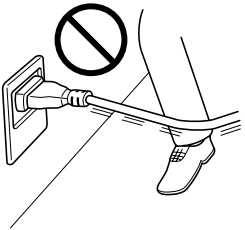
- Use only the power cord supplied in the package. If a power cord is not supplied, only use the power cord and plug that is specified in POWER CORD INSTRUCTION. Failure to use this cord could result in a fire or electrical shock. 
- Use the power cord supplied in the package only for this machine and NEVER use it for any other product. Failure to observe this precaution could result in a fire or electrical shock. 
- Do not scratch, abrade, place a heavy object on, heat, twist, bend, pull on, or damage the power cord. Use of a damaged power cord (exposed core wire, broken wire, etc.) could result in a fire or breakdown. Should any of these conditions be found, immediately turn OFF the power switch, unplug the power cord from the power outlet, and then call your authorized service representative.   

**Power source** **WARNING**

- Use only the specified power source voltage. Failure to do that could result in a fire or electrical shock. 

- Connect power plug directly into wall outlet having the same configuration as the plug. Use of an adapter leads to the product connecting to inadequate power supply (voltage, current capacity, grounding), and may result in fire or shock. If proper wall outlet is not available, the customer shall ask qualified electrician for the installation. 

- Do not use a multiple outlet adapter nor an extension cord in principle. Use of an adapter or an extension cord could cause a fire or electrical shock.   
Contact your authorized service representative if an extension cord is required.

- Consult your authorized service representative before connecting other equipment on the same wall outlet. Overload could result in a fire. 

 **CAUTION**

- The outlet must be near the equipment and easily accessible. Otherwise you can not pull out the power plug when an emergency occurs. 

**Power plug** **WARNING**

- Do not unplug and plug in the power cord with a wet hand, as an electrical shock could result.



- Plug the power cord all the way into the power outlet. Failure to do this could result in a fire or electrical shock.

 **CAUTION**

- Do not tug the power cord when unplugging. Pulling on the power cord could damage the cord, resulting in a fire or electrical shock.



- Remove the power plug from the outlet more than one time a year and clean the area between the plug terminals. Dust that accumulates between the plug terminals may cause a fire.

**Grounding** **WARNING**

- Connect the power cord to an electrical outlet that is equipped with a grounding terminal.









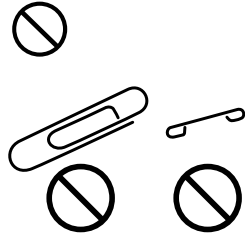

**Installation****⚠ WARNING**

- Do not place a flower vase or other container that contains water, or metal clips or other small metallic objects on this product. Spilled water or metallic objects dropped inside the product could result in a fire, electrical shock, or breakdown.

Should a piece of metal, water, or any other similar foreign matter get inside the product, immediately turn OFF the power switch, unplug the power cord from the power outlet, and then call your authorized service representative.

**⚠ CAUTION**

- After installing this product, mount it on a secure base. If the unit moves or falls, it may cause personal injury. 
- Do not place the product in a dusty place, or a site exposed to soot or steam, near a kitchen table, bath, or a humidifier. A fire, electrical shock, or breakdown could result. 
- Do not place this product on an unstable or tilted bench, or in a location subject to a lot of vibration and shock. It could drop or fall, causing personal injury or mechanical breakdown. 
- Do not let any object plug the ventilation holes of this product. Heat could accumulate inside the product, resulting in a fire or malfunction. 
- Do not use flammable sprays, liquids, or gases near this product, as a fire could result. 

**Ventilation** **CAUTION**

- Using this product in a poorly ventilated room for a long time or producing a large volume of copies or prints may cause the odor of exhaust air from the machine. Ventilate the room well.

**Actions in response to troubles** **WARNING**

- Do not keep using this product, if this product becomes inordinately hot or emits smoke, or unusual odor or noise. Immediately turn OFF the power switch, unplug the power cord from the power outlet, and then call your authorized service representative. If you keep on using it as is, a fire or electrical shock could result.
- Do not keep using this product, if this product has been dropped or its cover damaged. Immediately turn OFF the power switch, unplug the power cord from the power outlet, and then call your authorized service representative. If you keep on using it as is, a fire or electrical shock could result.

 **CAUTION**

- The inside of this product has areas subject to high temperature, which may cause burns. When checking the inside of the unit for malfunctions such as a paper misfeed, do not touch the locations (around the fusing unit, etc.) which are indicated by a “Caution HOT” caution label.



**Consumables****⚠ WARNING**

- Do not throw the toner cartridge or toner into an open flame. The hot toner may scatter and cause burns or other damage.

**⚠ CAUTION**

- Do not leave a toner unit or drum unit in a place within easy reach of children. Licking or ingesting any of these things could injure your health.
- Do not store toner units and PC drum units near a floppy disk or watch that are susceptible to magnetism. They could cause these products to malfunction.

**When moving the machine****⚠ CAUTION**

- Whenever moving this product, be sure to disconnect the power cord and other cables. Failure to do this could damage the cord or cable, resulting in a fire, electrical shock, or breakdown.
- When moving this product, always hold it by the locations specified in the User's Guide or other documents. If the unit falls it may cause severe personal injury. The product may also be damaged or malfunction.



When the optional Fax Kit FK-503 is not installed:

**Before successive holidays****⚠ CAUTION**

- Unplug the product when you will not use the product for long periods of time.



## 1.2 USER INSTRUCTIONS

### FCC PART 15 - RADIO FREQUENCY DEVICES (For U.S.A. Users)

**NOTE:** This equipment has been tested and found to comply with the limits for a Class A digital device, pursuant to Part 15 of the FCC Rules. These limits are designed to provide reasonable protection against harmful interference when the equipment is operated in a commercial environment. This equipment generates, uses and can radiate radio frequency energy and, if not installed and used in accordance with the instruction manual, may cause harmful interference to radio communications. Operation of this equipment in a residential area is likely to cause harmful interference in which case the user will be required to correct the interference at his own expense.

**WARNING:** The design and production of this unit conform to FCC regulations, and any changes or modifications must be registered with the FCC and are subject to FCC control. Any changes made by the purchaser or user without first contacting the manufacturer will be subject to penalty under FCC regulations.

This device must be used with shielded interface cables. The use of non-shielded cable is likely to result in interference with radio communications and is prohibited under FCC rules.

### INTERFERENCE-CAUSING EQUIPMENT STANDARD (ICES-003 ISSUE 4) (For Canada Users)

This Class A digital apparatus complies with Canadian ICES-003.

Cet appareil numérique de la classe A est conforme à la norme NMB-003 du Canada.

### For users in countries subject to Class B regulations

This device must be used with shielded interface cables. The use of non-shielded cable is likely to result in interference with radio communications and is prohibited under CISPR 22 rules and local rules.

### For users in countries not subject to Class B regulations

#### **WARNING**

This is a Class A product. In a domestic environment this product may cause radio interference in which case the user may be required to take adequate measures.

This device must be used with shielded interface cables. The use of non-shielded cable is likely to result in interference with radio communications and is prohibited under CISPR 22 rules and local rules.

## 1.3 Laser safety

This is a digital machine which operates using a laser. There is no possibility of danger from the laser provided the machine is operated according to the instructions in this manual.

Since radiation emitted by the laser is completely confined within protective housing, the laser beam cannot escape from the machine during any phase of user operation.

This machine is certified as a Class 1 laser product: This means the machine does not produce hazardous laser radiation.

### Internal laser radiation

Maximum Average Radiation Power: 28.9  $\mu$ W at the laser aperture of the print head unit.

Wavelength: 770-795 nm

This product employs a Class 3b laser diode that emits an invisible laser beam.

The laser diode and the scanning polygon mirror are incorporated in the print head unit.

The print head unit is NOT A FIELD SERVICE ITEM:

Therefore, the print head unit should not be opened under any circumstances.

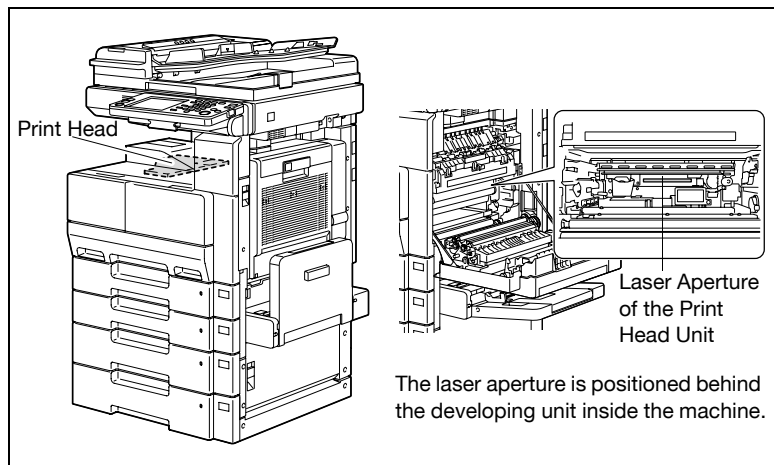

**CDRH regulation**

This machine is certified as a Class 1 Laser product under Radiation Performance Standard according to the Food, Drug and Cosmetic Act of 1990. Compliance is mandatory for Laser products marketed in the United States and is reported to the Center for Devices and Radiological Health (CDRH) of the U.S. Food and Drug Administration of the U.S. Department of Health and Human Services (DHHS). This means that the device does not produce hazardous laser radiation.

The label shown on page 1-13 indicates compliance with the CDRH regulations and must be attached to laser products marketed in the United States.

---

**CAUTION**

Use of controls, adjustments or performance of procedures other than those specified in this manual may result in hazardous radiation exposure.

---

This is a semiconductor laser. The maximum power of the laser diode is 5mW and the wavelength is 770-795 nm.

**For European users**

---

**CAUTION**

Use of controls, adjustments or performance of procedures other than those specified in this manual may result in hazardous radiation exposure.

---

This is a semiconductor laser. The maximum power of the laser diode is 5mW and the wavelength is 770-795 nm.

**For Denmark users**

---

**ADVARSEL**

Usynlig laserstråling ved åbning, når sikkerhedsafbrydere er ude af funktion. Undgå udsættelse for stråling. Klasse 1 laser produkt der opfylder IEC60825 sikkerheds kravene.

---

Dansk: Dette er en halvlederlaser. Laserdiodens højeste styrke er 5mW og bølgelængden er 770-795 nm.

---

**For Finland, Sweden users**

---

LOUKAN 1 LASERLAITE  
KLASS 1 LASER APPARAT

---

**VAROITUS!**

Laitteen Käyttäminen muulla kuin tässä käyttöohjeessa mainitulla tavalla saattaa altistaa käyttäjän turvallisuusluokan 1 ylittävälle näkymättömälle lasersäteilylle.

---

Tämä on puolijohdelaser. Laserdiodin suurin teho on 5mW ja aallonpituus on 770-795 nm.

---

**WARNING!**

Om apparaten används på annat sätt än i denna bruksanvisning specificerats, kan användaren utsättas för osynlig laserstrålning, som överskrider gränsen för laserklass 1.

---

Det här är en halvledarlaser. Den maximala effekten för laserdioden är 5mW och våglängden är 770-795 nm.

---

**VARO!**

Avattaessa ja suojalukitus ohitettaessa olet alttiina näkymättömälle lasersäteilylle. Älä katso säteeseen.

---

**WARNING!**

Osynlig laserstrålning när denna del är öppen och spärren är urkopplad. Betrakta ej strålen.

---

**For Norway users**

---

**ADVERSEL**

Dersom apparatet brukes på annen måte enn spesifisert i denne bruksanvisning, kan brukeren utsettes for usynlig laserstråling som overskrider grensen for laser klass 1.

---

Dette en halvleder laser. Maksimal effekt till laserdiode er 5mW og bølglengde er 770-795 nm.

## Laser safety label

A laser safety label is attached to the outside of the machine as shown below.

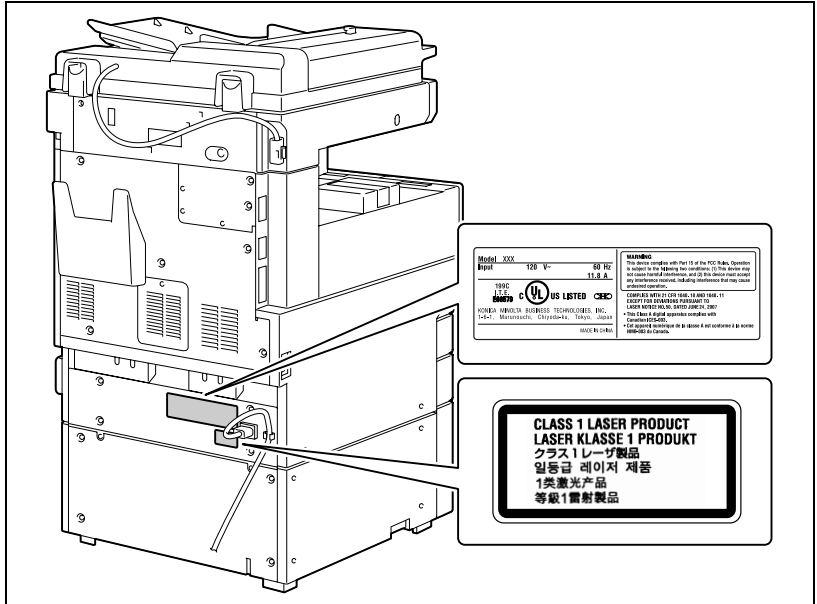

## Ozone release

### CAUTION

#### Locate the Machine in a Well Ventilated Room

- A negligible amount of ozone is generated during normal operation of this machine. An unpleasant odor may, however, be created in poorly ventilated rooms during extensive machine operations. For a comfortable, healthy, and safe operating environment, it is recommended that the room well ventilated.



**REMARQUE**

= Placer l'appareil dans une pièce largement ventilée =

Une quantité d'ozone négligable est dégagée pendant le fonctionnement de l'appareil quand celui-ci est utilisé normalement. Cependant, une odeur désagréable peut être ressentie dans les pièces dont l'aération est insuffisante et lorsque une utilisation prolongée de l'appareil est effectuée. Pour avoir la certitude de travailler dans un environnement réunissant des conditions de confort, santé et de sécurité, il est préférable de bien aérer la pièce où se trouve l'appareil.

**Acoustic noise (For European users only)**

Maschinenlärminformations-Verordnung 3. GPSGV: Der höchste Schalldruckpegel beträgt 70 dB(A) oder weniger gemäss EN ISO 7779.

**Notification for US only**

Contains Mercury in the LCD control panel backlighting lamp, and/or in the scanning unit lamp. Dispose According to Local, State or Federal Laws.

**Recycling batteries (For Taiwan Users Only)**

根據地方規定處理使用的電池。

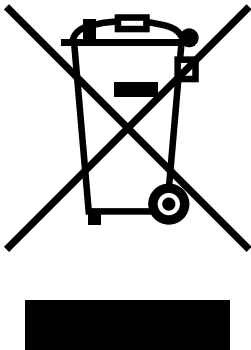
**For EU member states only**

This symbol means: Do not dispose of this product together with your household waste!

Please refer to the information of your local community or contact our dealers regarding the proper handling of end-of-life electric and electronic equipments. Recycling of this product will help to conserve natural resources and prevent potential negative consequences for the environment and human health caused by inappropriate waste handling.

**For EU member states only**

This product complies with RoHS (2002/95/EC) Directive.

This device is not intended for use at a video workstation in compliance with BildscharbV.

Das Gerät ist nicht für die Benutzung am Bildschirmarbeitsplatz gemäß BildscharbV vorgesehen.

## 1.4 Caution notations and labels

Safety precaution notations and labels appear on this machine at the following positions.

Be very careful that an accident does not occur when operations such as removing paper misfeeds are performed.

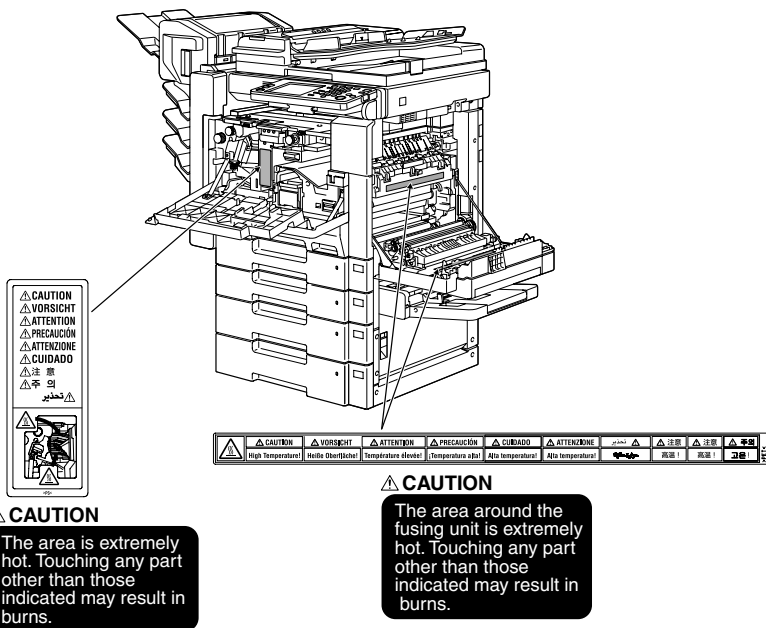

## 1.5 Space requirements

To ensure that machine operation, consumables replenishing, part replacement, and regular maintenance can easily be performed, adhere to the recommended space requirements detailed below.

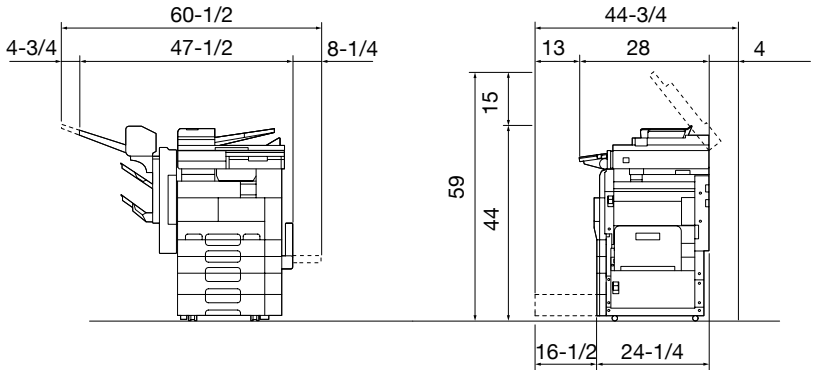

Unit: inch



### Reminder

*Be sure to allow a clearance of 4 inch (100 mm) or more at the back of this machine for the ventilation duct.*

## 1.6 Operation precautions

To ensure the optimum performance of this machine, observe the precautions described below.

### Power source

The power source requirements are as follows.

- Voltage fluctuation: Maximum  $\pm 10\%$  (at 120 V/220-240 V AC)
- Frequency fluctuation: Maximum  $\pm 2.5$  Hz (at 50 Hz/60 Hz)
- Use a power source with as little voltage or frequency fluctuations as possible.

### Operating environment

The environmental requirements for correct operation of the machine are as follows.

- Temperature: 50°F (10°C) to 89.6°F (32°C) with fluctuations of no more than 18°F (10°C) within an hour
- Humidity: 15% to 85% with fluctuations of no more than 20% within an hour
- However, in an environment with a temperature of 89.6°F (32°C), maintain a relative humidity of 65% or less.

### Storage of copies

To store copies, follow the recommendation listed below.

- Copies that are to be kept for a long time should be kept where they are not exposed to light in order to prevent them from fading.
- Adhesive that contains solvent (e.g., spray glue) may dissolve the toner on copies.
- Color copies have a thicker layer of toner than normal black-and-white copies. Therefore, when a color copy is folded, the toner at the fold may peel off.

---



## **Before making copies**

## 2 Before making copies

### 2.1 Part names and their functions

#### Options

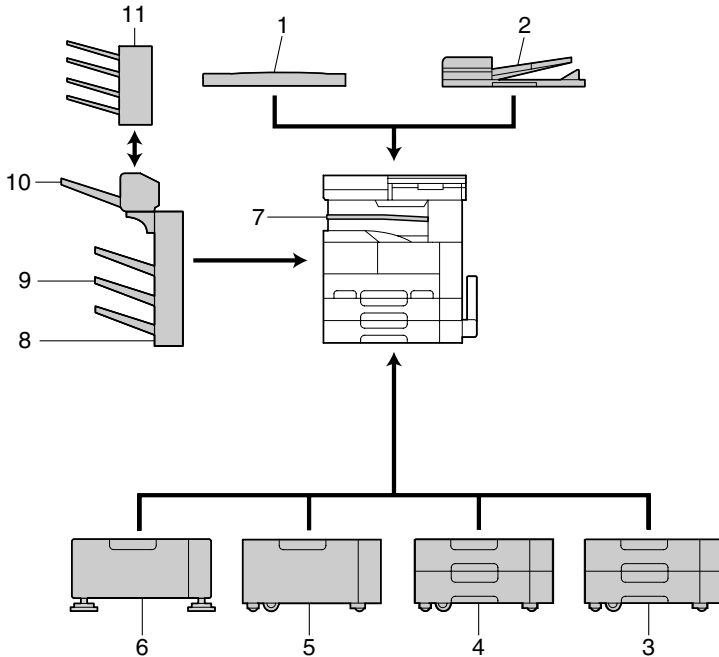

No	Part name	Description
	Main unit	The document is scanned by the scanner section, and the scanned image is printed by the printer section. Referred to as the "machine" or "main unit" throughout the manual.
1	Original Cover OC-510	Presses down on the loaded document to keep it in place. Referred to as the "original cover" throughout the manual.

No	Part name	Description
2	Reverse Automatic Document Feeder DF-620	Automatically feeds one document sheet at a time for scanning, and automatically turns over double-sided documents for scanning if the document was set as double-side from the touch panel Referred to as the “ADF” throughout the manual.
3	Paper Feed Cabinet PC-108	The top tray can be loaded with up to 500 sheets of paper, and the bottom tray can be used as storage. Referred to as the “single paper feed cabinet” throughout the manual.
4	Paper Feed Cabinet PC-206	Both the top and bottom trays can each be loaded with up to 500 sheets of paper. Referred to as the “double paper feed cabinet” throughout the manual.
5	Paper Feed Cabinet PC-407	Can be loaded with up to 2,500 sheets of paper Referred to as the “LCT” throughout the manual.
6	Desk DK-506	Allows this machine to be set up on the floor Referred to as the “desk” throughout the manual.
7	Job Separator JS-502	Allows printed pages to be separated Pull the lever when taking out the paper. Referred to as the “job separator” throughout the manual.
8	Finisher FS-530	Feeds out printed pages. The “Sort” setting (separate by copy set), “Group” setting (separate by page), Staple settings (stapling), and Punch settings (hole punching) are available. Referred to as the “finisher” throughout the manual.
9	Output Tray OT-602	Copy output tray installed onto the finisher and used for separating printed pages Referred to as the “optional output tray” throughout the manual.
10	Saddle Stitcher SD-507	Installed onto the finisher to allow copies to be stapled or bound at the center Referred to as the “saddle stitcher” throughout the manual.
11	Mailbin Kit MT-502	Installed onto the finisher to divide printed pages and feed them into the appropriate bin assigned to a specific individual or group (only with PC printing) Referred to as the “mailbin” throughout the manual.
12	Punch Unit PU-501*	Installed onto the finisher to allow hole punching to be used Referred to as the “punch unit” throughout the manual.
13	Fax Kit FK-503*	Allows this machine to be used as a fax machine



No	Part name	Description
14	Scanner Unit SU-501*	Internal network scanner unit that allows the copier to be used as a scanner configured into a computer network For details, refer to the User's Guide [Advanced Scan Operations].
15	Hard Disk HD-504*	Increases the number of document pages to be scanned. In addition, multiple jobs can be scanned.
16	Expanded Memory Unit EM-303/304/305*	By expanding the memory, the number of scanned pages that can be stored in the memory can be increased. Referred to as the "expansion memory" throughout the manual.
17	Fax Multi Line ML-502*	Installed to increase the telephone lines available for faxing
18	Dehumidifier Heater 1C*	Installed in the paper feed cabinet or desk to prevent humidity from collecting in the paper
19	Local Interface Kit EK-502*	Used for making a local connection between this machine and the computer
20	Mount Kit MK-709*	Installs the device to remotely control the machine. If the fax kit is installed, this option is not needed.
21	Stamp Unit SP-501*	Used installed on the ADF Stamps scanned document pages to indicate that they have been faxed
22	Security Kit SC-504*	Installed to encrypt the data saved on the hard disk so that the hard disk can be used more safely.

Parts marked with an asterisk (\*) are internal options and therefore are not shown in the illustration.

## Outside of machine

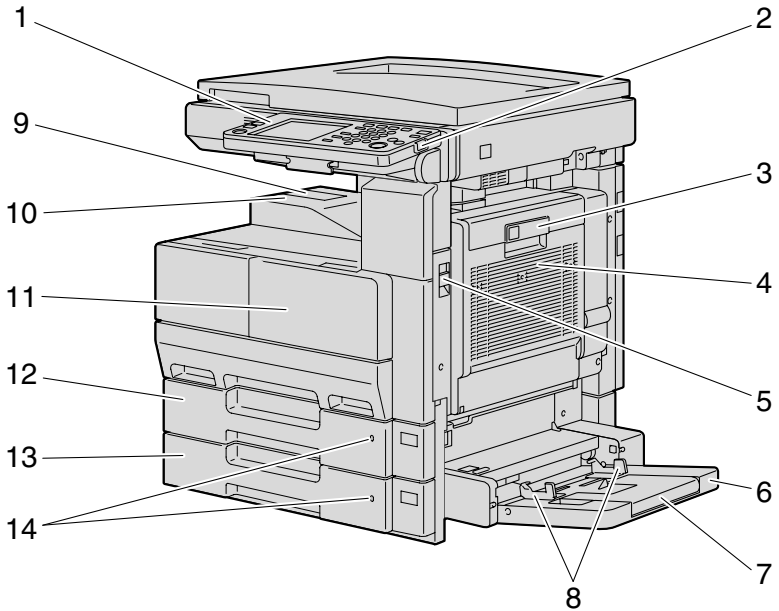

\*The illustration above shows the main unit with the optional original cover installed.

No.	Part name	Description
1	Control panel	Used to specify the various settings and perform operations such as starting copying
2	[Power] (auxiliary power) key	Press to turn on and off machine operations, for example, for copying, printing or scanning. When turned off, the machine enters a state where it conserves energy.
3	Automatic duplex unit door release lever	Used to open the automatic duplex unit door
4	Automatic duplex unit door	Opened when clearing paper misfeeds within the automatic duplex unit
5	Release lever for main unit right-side door	Used to open the right-side door of the main unit

No.	Part name	Description
6	Multiple bypass tray	Used when printing onto paper with a size not loaded into a paper tray or onto thick paper, overhead projector transparencies, postcards, envelopes or label sheets Can be loaded with up to 150 sheets of plain paper, 50 overhead projector transparencies, postcards, label sheets or sheets of thick paper, or 10 envelopes Referred to as the "bypass tray" throughout the manual. (See page 2-60)
7	Tray extension	Pull out when large-sized paper is to be loaded.
8	Adjustable document guides	Adjust to the width of the paper.
9	Paper stopper	Prevents printed pages from falling out of the output tray. Use when the optional job separator is installed.
10	Copy output tray	Collects printed pages fed out of the copier facing down
11	Front door	Opened when replacing the toner bottle (See page 9-2)
12	1st tray	Can be loaded with up to 500 sheets of paper The paper size can be adjusted freely. (See page 2-54)
13	2nd tray	Can be loaded with up to 500 sheets of paper The paper size can be adjusted freely. (See page 2-54)
14	Paper-empty indicator	As the amount of paper in the paper tray decreases, the area that appears in red increases.

**Inside/back of main unit**

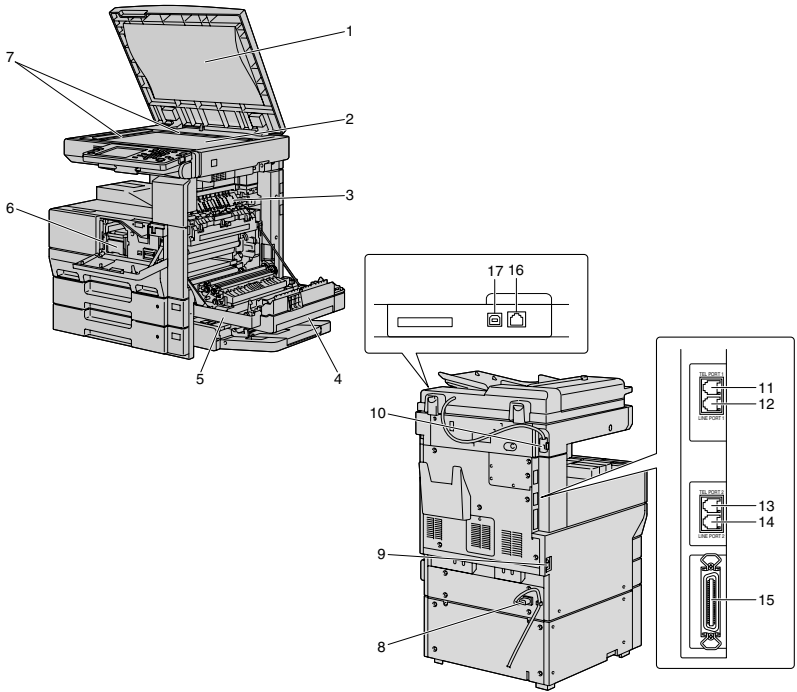

\*The illustration above shows the main unit with the optional original cover and ADF installed.

No.	Part name	Description
1	Document pad	Presses down on the document positioned on the original glass
2	Original glass	Scans the image of the loaded document (See page 3-10)
3	Switchback unit	Built into the printer to turn over the paper during double-sided printing
4	Automatic duplex unit	Turns over the paper for double-sided printing
5	Right-side door	Open when clearing paper misfeeds in the right-side door unit or the fusing unit
6	Toner hopper	Used when installing and replacing the toner bottles
7	Document scales	Used to align the document (See page 3-10)
8	Power cord	Supplies power to the machine

No.	Part name	Description
9	Main power switch	Used to turn the machine on and off (See page 2-22, page 2-26)
10	ADF connector	Used for connecting the ADF hookup cord
11	TEL PORT1 jack	Used for connecting a telephone
12	LINE PORT1 jack	Used for connecting the general subscriber line
13	TEL PORT2 jack	Used for connecting the cord from the telephone
14	LINE PORT2 jack	Used for connecting the general subscriber line
15	IEEE1284 port (type C)	Used for connecting a parallel cable from the computer
16	Network connector (10 Base-T/100 Base-TX)	Used for connecting the network cable when this machine is used for network printing and network scanning
17	USB port (type B) USB 2.0/1.1-compliant	Used for connecting a USB cable from the computer
18	Ozone filter*	Collects the ozone generated in the machine
19	Filter*	Collects the toner dust generated in the machine

Parts marked with an asterisk (\*) are internal options and therefore are not shown in the illustration.

## Reverse Automatic Document Feeder DF-620

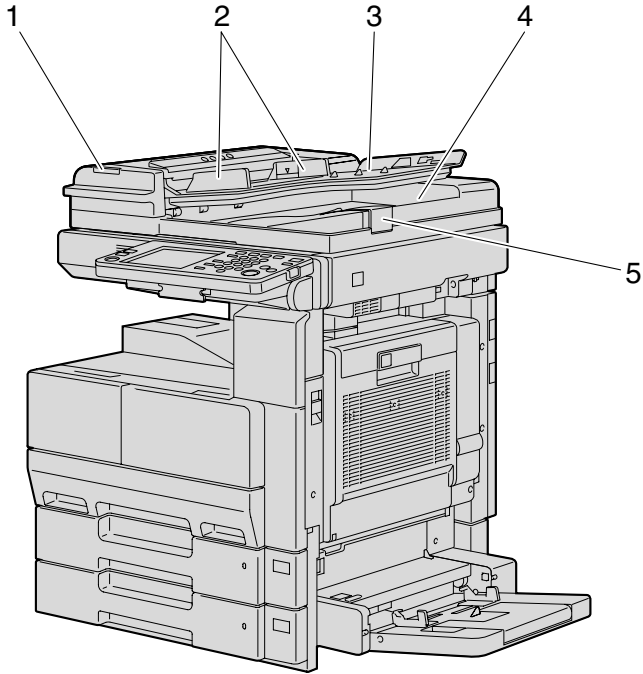

No.	Part name	Description
1	Print indicator	Lights up or flashes to indicate the status of the machine
2	Adjustable document guide	Adjusted to the width of the document (See page 3-8)
3	Document feed tray	Loaded with the documents to be scanned facing up
4	Document output tray	Collects documents that have been scanned
5	Document stopper	Raised to prevent large-sized documents from falling out of the document output tray

## Paper Feed Cabinet PC-108/PC-206/PC-407

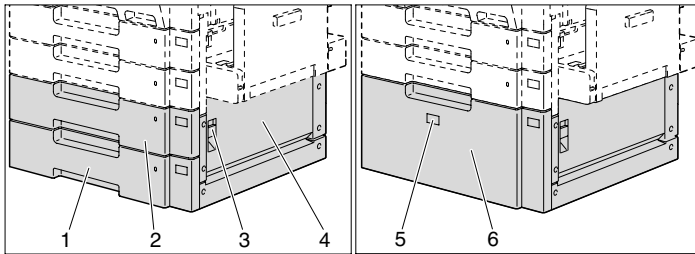
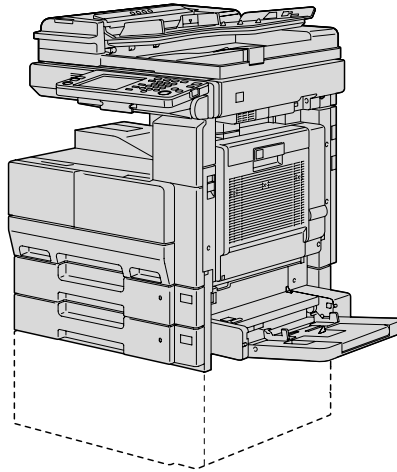

## Paper Feed Cabinet PC-108/PC-206

No.	Part name	Description
1	4th tray	Used for storage when the single paper feed cabinet is installed Can be loaded with up to 500 sheets of paper when the double paper feed cabinet is installed
2	3rd tray	Can be loaded with up to 500 sheets of paper
3	Lower right-side door release lever	Used to open the lower right-side door
4	Lower right-side door	Opened when clearing paper misfeeds

## Paper Feed Cabinet PC-407

No.	Part name	Description
5	Tray release button	Pressed in order to pull out the LCT
6	LCT	Can be loaded with up to 2,500 sheets of paper

## Saddle Stitcher SD-507/Mailbin Kit MT-502

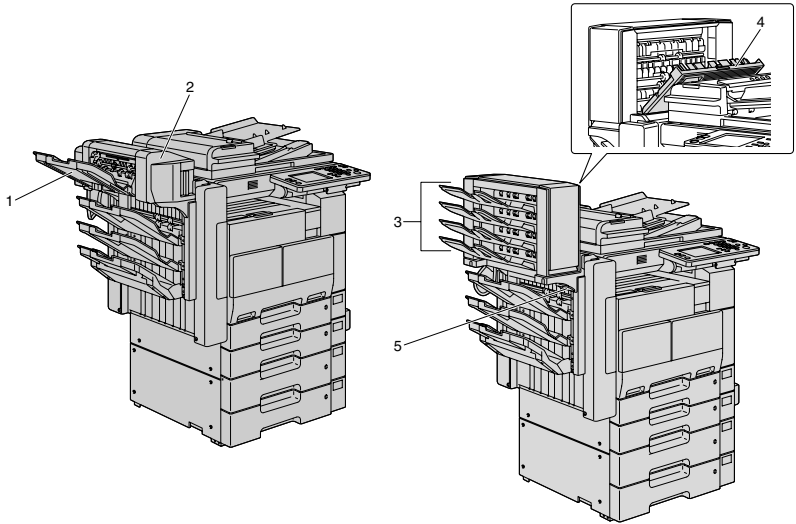

## Saddle Stitcher SD-507

No.	Part name	Description
1	Copy output tray	Collects copies
2	Misfeed-clearing door	Opened when clearing paper misfeeds within the finisher

## Mailbin Kit MT-502

No.	Part name	Description
3	Mailbins	Collects printed pages
4	Misfeed-clearing door	Opened when clearing paper misfeeds
5	Output tray cover	Opened when clearing paper misfeeds



## Finisher FS-530/Output Tray OT-602/Punch Unit PU-501

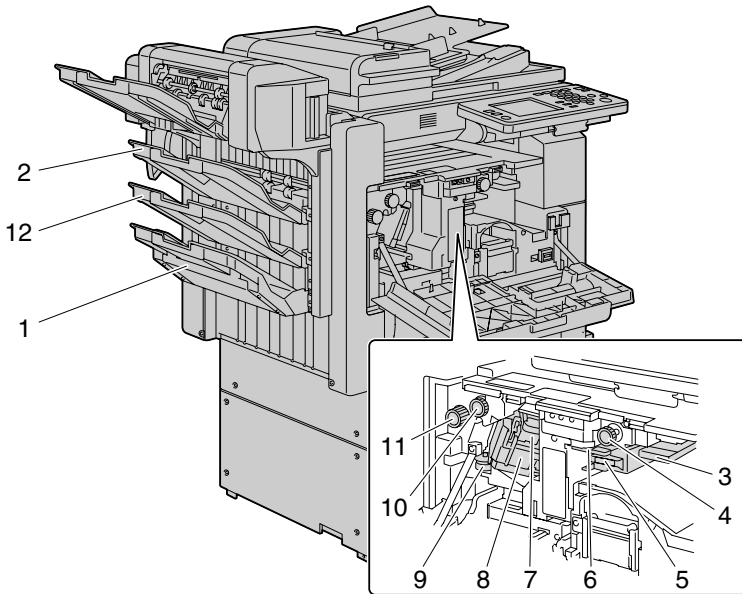

## Finisher FS-530

No.	Part name	Description
1	Output tray 2 (elevated tray)	Collects copies that are fed out
2	Output tray 1 (non-sorted copy tray)	Collects copies that are fed out
3	Lever FN1	Lowered when clearing paper misfeeds within the finisher
4	Dial FN2	Turned when clearing paper misfeeds within the finisher
5	Hole-punch waste container	Removed when emptying hole-punch waste that has accumulated from using the punch settings
6	Lever FN3	Lowered when clearing paper misfeeds within the finisher
7	Lever FN4	Lowered when clearing paper misfeeds within the finisher
8	Staple cartridge holder	Removed from the stapler unit when replacing the staple cartridge or clearing jammed staples

No.	Part name	Description
9	Dial	Turned to move the staple cartridge holder toward you when replacing the staple cartridge or clearing jammed staples
10	Dial FN5	Turned when clearing paper misfeeds within the finisher
11	Dial FN6	Turned when clearing paper misfeeds within the finisher

### Output Tray OT-602

No.	Part name	Description
12	Optional output tray	Collects copies

### Punch Unit PU-501

No.	Part name	Description
13	Punch Unit*	Punches holes for filing printed pages when punch unit is installed onto finisher

Parts marked with an asterisk (\*) are installed within the finisher and therefore are not shown in the illustration.

Precautions for using the finisher:

- Do not place objects on top of the saddle stitcher or mailbin kit.
- Do not place objects below the output trays of the finisher.

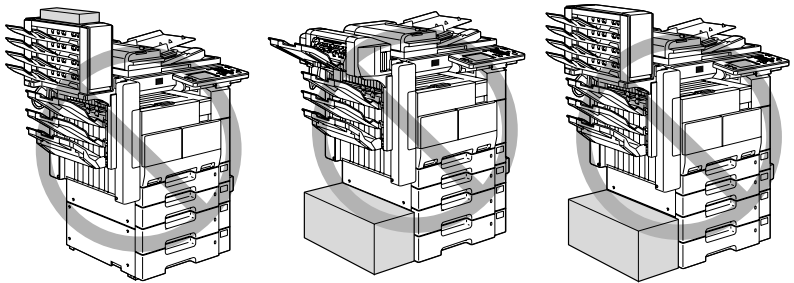

## Control panel

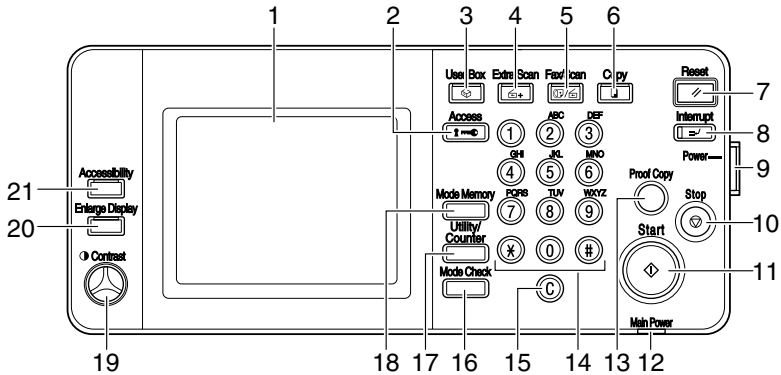

No.	Part name	Description
1	Touch panel	Displays various screens and messages. Specify the various settings by directly touching the panel.
2	[Access] key	If user authentication or account track settings have been applied, press this key after entering the user name and password (for user authentication) or the account name and password (for account track) in order to use this machine.
3	[User Box] key	Press to enter Box mode. While the machine is in Box mode, the indicator on the [User Box] key lights up in green. For details, refer to the User's Guide [Box Operations].
4	[Extra Scan] key	Press to enter Extra Scan mode. While the machine is in Extra Scan mode, the indicator on the [Extra Scan] key lights up in green. For details, refer to the User's Guide [Network Scanner Operations] and the User's Guide [Advanced Scan Operations].
5	[Fax/Scan] key	Press to enter Fax/Scan mode. While the machine is in Fax/Scan mode, the indicator on the [Fax/Scan] key lights up in green. For details, refer to the User's Guide [Facsimile Operations] and the User's Guide [Advanced Scan Operations].
6	[Copy] key	Press to enter Copy mode. (As a default, the machine is in Copy mode.) While the machine is in Copy mode, the indicator on the [Copy] key lights up in green.

No.	Part name	Description
7	[Reset] key	Press to clear all settings (except programmed settings) entered in the control panel and touch panel.
8	[Interrupt] key	Press to enter Interrupt mode. While the machine is in Interrupt mode, the indicator on the [Interrupt] key lights up in green and the message "Now in Interrupt mode." appears on the touch panel. To cancel Interrupt mode, press the [Interrupt] key again.
9	[Power] (auxiliary power) key	Press to turn on and off machine operations, for example, for copying, printing or scanning. When turned off, the machine enters a state where it conserves energy.
10	[Stop] key	Press the [Stop] key during copying to stop the copy operation.
11	[Start] key	Press to start copying. When this machine is ready to begin copying, the indicator on the [Start] key lights up in green. If the indicator on the [Start] key lights up in orange, copying cannot begin. Press to restart a stopped job. For details on jobs, refer to "Job List screens" on page 4-21
12	Main Power indicator	Lights up in green when the machine is turned on with the main power switch
13	[Proof Copy] key	Press to print a single proof copy to be checked before printing a large number of copies. (See page 4-5)
14	Keypad	Use to type in the number of copies to be produced. Use to type in the zoom ratio. Use to type in the various settings.
15	[C] (clear) key	Press to erase a value (such as the number of copies, a zoom ratio, or a size) entered using the keypad.
16	[Mode Check] key	Press to display screens showing the specified settings.
17	[Utility/Counter] key	Press to display the Utility/Counter screen.
18	[Mode Memory] key	Press to register the desired copy settings as a program or to recall a registered copy program. (See page 4-8)
19	Contrast dial	Use to adjust the contrast of the touch panel.
20	[Enlarge Display] key	Press to enter Enlarge Display mode.
21	[Accessibility] key	Press to display the screen for specifying user accessibility functions.

**Reminder**

*Do not apply extreme pressure to the touch panel, otherwise it may be scratched or damaged.*

*Never push down on the touch panel with force, and never use a hard or pointed object to make a selection in the touch panel.*

**Detail**

*A function other than a copy function cannot be selected while pages are being scanned for copying or while copying is paused.*

## Basic settings screen (Basics screen)





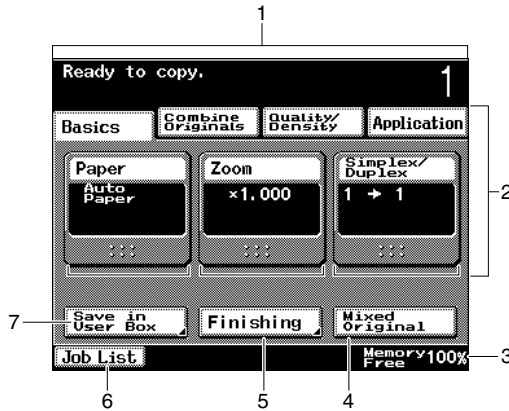







When the machine is ready to begin making copies after being turned on, the Basics screen appears.

To activate a function or to select a setting, lightly touch the desired button in the touch panel.



No.	Item name	Description
1	Message display area	The status of the machine and details on operations that must be performed are displayed here.
2	Functions/settings display	Tabs and buttons for displaying screens containing various functions are displayed. Touch a tab or button to display the corresponding screen for specifying the settings.
3	Status display area	The amount of memory space available in addition to icons indicating the status of jobs and the machine are displayed.
4	[Mixed Original] button	Touch to scan a document containing pages of different sizes. (See page 3-16)
5	[Finishing] button	Touch to specify settings for sorting, grouping, stapling, or hole punching. (See page 3-50)
6	[Job List] button	Jobs currently being performed or waiting to be performed can be checked. (See page 4-21)
7	[Save in User Box] button (Appears only when the hard disk drive is installed)	Touch to save the data of scanned documents in boxes. The destination boxes can be created, file names can be specified, and saved documents can be printed. For details, refer to the User's Guide [Box Operations].

## Icons that appear in the screen

Icon	Description
	Indicates that copies are being made
	Indicates that pages are being printed
	Indicates that printing was stopped
	Indicates that data is waiting to be printed
	Indicates that computer data is being received
	Indicates that computer data waiting to be printed remains
	Indicates that the selected paper tray is empty
	Indicates that the toner bottle must be replaced
	Indicates that the imaging unit must be replaced
	Indicates that the time for the periodic maintenance has passed on a machine that requires a periodic maintenance
	Indicates that user authentication or account track settings have been specified on this machine
	Indicates that copying was stopped when a proof copy is printed
	Indicates that "Enhance Security" is set to "ON"

### Enlarging the touch panel screens

Press the [Enlarge Display] key. Then, touch the touch panel to display the selected area enlarged at the center of the panel. Press the [Enlarge Display] key again to return the screens to the standard size. The usual touch panel operations can be performed even when the screens are enlarged.

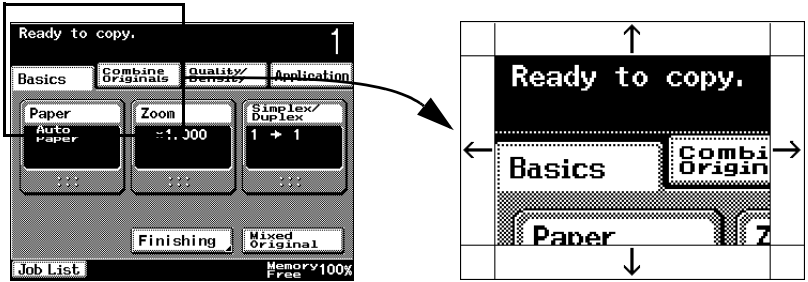

Touch in this area to scroll up and to the left.

Touch this arrow to scroll up.

Touch in this area to scroll up and to the right.

Touch this arrow to scroll left. When the left edge of the screen is reached, the screen is scrolled down one line and the right edge is displayed.

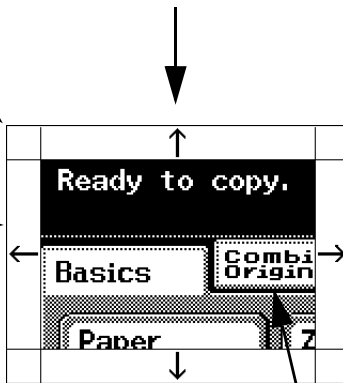

Touch this arrow to scroll right. When the right edge of the screen is reached, the screen is scrolled down one line and the left edge is displayed.

Touch in this area to scroll down and to the left.

Touch this arrow to scroll down.

Touch in this area to scroll down and to the right.

When a button on the screen is touched to display a different screen, the screen returns to its standard size. However, touching the touch panel again displays the screen enlarged.



## 2.2 Adjusting the angle of the control panel

The control panel can be adjusted to any of three angles.

Adjust the control panel to the angle that allows for easy operation.

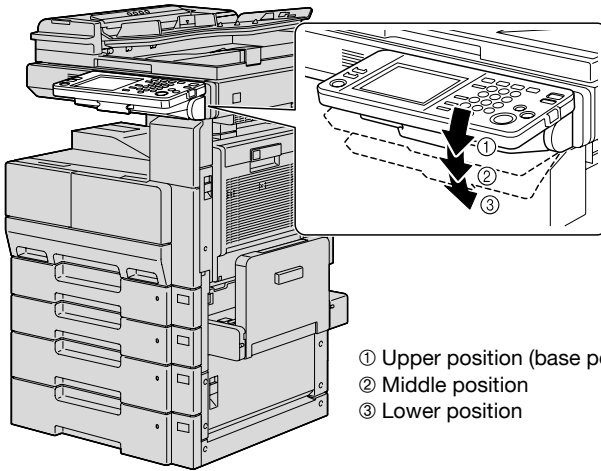

### To adjust the angle of the control panel

- 1 Pull the control panel release lever toward you, and then push down on the control panel.

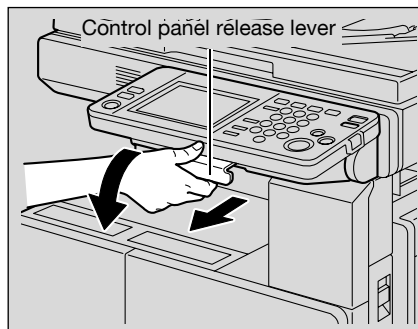

The control panel stops at the middle position.

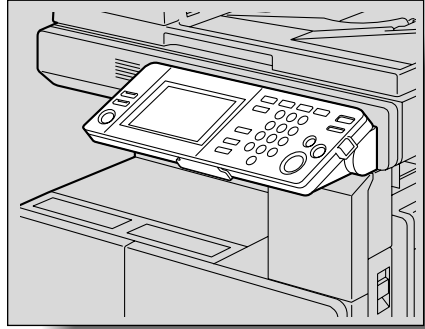

- 2** To adjust the control panel to an even steeper angle, pull the control panel release lever toward you, and then push down on the control panel.

The control panel stops at the lower position.

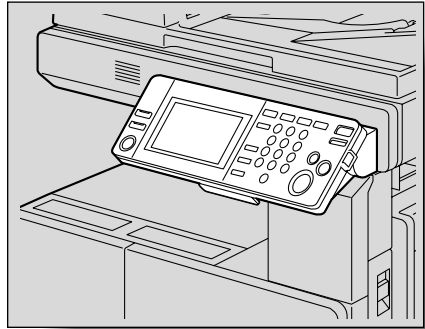

- 3** To return the control panel to the upper position, pull the control panel release lever toward you, and then pull up on the control panel.

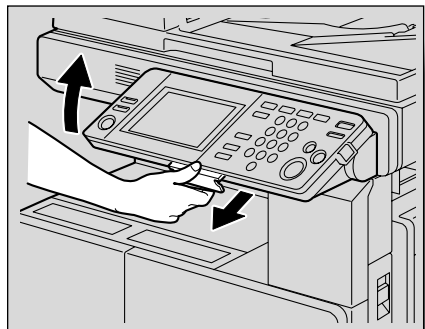

## 2.3 Turning on the main power and the auxiliary power

This machine has two power controls: the main power switch and the [Power] (auxiliary power) key.

### To turn on the machine

The main power switch turns on/off all functions of the machine. Normally, the main power switch is turned on.

The [Power] (auxiliary power) key turns on/off machine operations, for example, for copying, printing or scanning. When the [Power] (auxiliary power) key is turned off, the machine enters a state where it conserves energy.

- 1 Set the main power switch to [I].

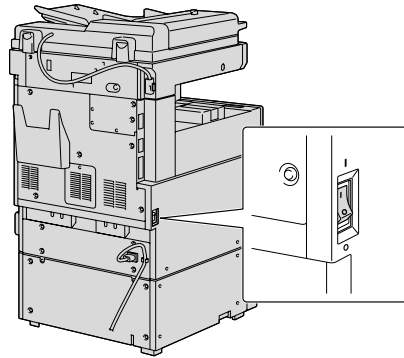

- 2 Press the [Power] (auxiliary power) key.

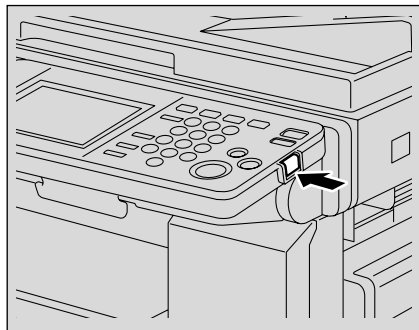

**Detail**

*When the [Power] (auxiliary power) key is turned on, the indicator on the [Start] key lights up in orange, and a screen indicating that the machine is starting up appears.*

*After a few seconds, the message “Now warming up. Ready to scan.” appears on the touch panel, and the indicator on the [Start] key lights up in green, indicating that a job can now be queued.*

*The default settings are the settings that are selected immediately after the machine is turned on and before any setting is specified from the control panel or touch panel, and those that are selected when the [Reset] key is pressed to cancel all settings specified from the control panel or touch panel. The default settings can be changed. For more details, refer to “Specifying User’s Choice settings” on page 11-9.*

*The factory default settings are the settings that were selected when this machine was sent from the factory.*



...

**Note**

*A job can also be queued while the machine is warming up after the [Power] (auxiliary power) key is turned on. For details, refer to “To scan during warm-up” on page 2-24.*

*After the machine has finished warming up, the scanned image will be printed.*

*The machine takes about 14 seconds to warm up at normal room temperature (73.4°F) when the [Power] (auxiliary power) key is turned on after the main power switch is turned on.*

## To scan during warm-up

- 1 Press the [Power] (auxiliary power) key.

The indicator on the [Start] key lights up in orange.

A screen appears, indicating that the machine is warming up.

? How is the machine turned on?

→ For details on turning on the machine, refer to “To turn on the machine” on page 2-22.

- 2 After the warm-up screen is displayed, the Basics screen appears.  
  
After the message “Now warming-up. Ready to scan.” is displayed, the message “Ready to copy.” appears.  
The indicator on the [Start] key lights up in green.



- 3 Specify the necessary copy settings.

? How is the number of copies specified?

→ For details on specifying the number of copies, refer to “General copy operation” on page 3-2.

- 4 Using the keypad, specify the desired number of copies.

- 5 Position the document to be copied.

? How is the document positioned?

→ For details on positioning the document, refer to “Feeding the document” on page 3-8.

- 6 Press the [Start] key.  
The document is scanned, and the job is added to the list of queued jobs.
- 7 Check that the document has finished being scanned, and then position the next document.
- 8 Specify new copy settings and the desired number of copies, and then press the [Start] key.
  - After the machine has finished warming up, the jobs will automatically be printed in the order that they were queued.
  - ? How is the printing of a job stopped?
    - Press the [Stop] key. For details, refer to “Stopping/deleting a job” on page 3-63.

**Detail**

*While the machine is warming up to begin printing after it is turned on using the [Power] (auxiliary power) key, copy settings can be specified and a document can be scanned to reserve a copy job. After the machine has finished warming up, the copies are automatically printed.*

## To turn off the machine

- 1 Press the [Power] (auxiliary power) key.  
The touch panel goes off.
- 2 Set the main power switch to [O].

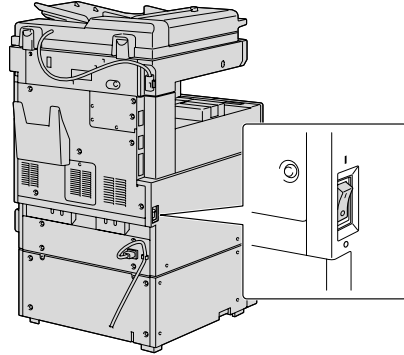

### Reminder

*When turning the machine off, then on again with the main power switch, wait about 10 seconds to turn the machine on after turning it off. The machine may not operate correctly if it is turned on immediately after being turned off.*

*Do not turn off the machine with the main power switch or the [Power] (auxiliary power) key while it is making copies or printing, otherwise a paper misfeed may occur.*

*Do not turn off the machine with the main power switch or the [Power] (auxiliary power) key while it is scanning or sending or receiving data, otherwise all scanned data or transmission data will be deleted.*

*Do not turn off the machine with the main power switch while a queued job or stored data is waiting to be printed, otherwise the jobs will be deleted.*



### Detail

*The following are cleared when the main power switch and [Power] (auxiliary power) key are turned off.*

- Settings that have not been programmed
- Jobs queued to be printed

**Automatically returning to the default settings (Automatic panel reset)**

If the [Reset] key is not pressed and no operation is performed for a specified length of time, settings that have not been programmed, such as the number of copies, are cleared and return to their default settings.

This is the automatic panel reset operation.

As the factory default, the automatic panel reset operation is performed after 1 minute.

**Detail**

*The length of time until the automatic panel reset operation is performed and whether or not it is performed can be set from Utility mode. For details, refer to "Auto Reset" on page 11-13.*

*Whether or not the automatic panel reset operation is performed when there is a change of user can be set from the Utility mode. For details, refer to "Auto Reset when Account is changed" on page 11-14.*

**Automatically returning to the screen given priority**

If no operation is performed for a specified length of time, the screen is automatically changed to that for the mode given priority.

As the factory default, the Copy mode screen is displayed after 1 minute.

**Detail**

*The mode screen that is displayed can be changed from the Utility mode. For details, refer to "Default Screen" on page 11-17.*



### Automatically conserving energy (Low Power mode)

If no operation is performed for a specified length of time, the touch panel goes off, and the machine enters a mode where it conserves energy.

This is the Low Power mode.

The machine can receive jobs even while it is in Low Power mode.

As the factory default, the machine enters Low Power mode after 15 minutes.

To recover from Low Power mode

- 1 Press any key in the control panel or touch the touch panel.
  - The Low Power mode can also be canceled by opening the original cover or loading a document into the ADF.
- 2 The machine can receive jobs while it is warming up.
  - The touch panel comes on again and, after the machine has finished warming up, it is ready to begin printing (within 14 seconds at normal room temperature (73.4°F)).



#### Detail

*The length of time until the machine enters Low Power mode can be set from Utility mode. For details, refer to “Low Power Mode” on page 11-13.*

### Automatically conserving energy (Sleep mode)

If no operation is performed for a specified length of time, the machine automatically enters a mode where it conserves energy.

The machine conserves more power in Sleep mode than in Low Power mode.

As the factory default, the machine enters Sleep mode after 1 minute.

To recover from Sleep mode

- 1 Press any key in the control panel or touch the touch panel.
  - The Sleep mode can also be canceled by opening the original cover or loading a document into the ADF.

- 2 The machine can receive jobs while it is warming up.
  - The touch panel comes on again and, after the machine has finished warming up, it is ready to begin printing (within 30 seconds at normal room temperature (73.4°F)).

**Detail**

*The length of time until the machine enters Sleep mode can be set from Utility mode. For details, refer to "Sleep Mode" on page 11-13.*

**Darkening the touch panel (LCD Back-Light Off)**

If no operation is performed for a specified length of time, the touch panel goes off and the machine enters a mode where it conserves energy.

The power conservation effect is slightly reduced; however, the machine can quickly recover to begin copying or printing.

As the factory default, the touch panel goes off after 1 minute.

To turn on the touch panel backlight

- 1 Press any key in the control panel or touch the touch panel.
  - The touch panel can also be turned on by opening the original cover or loading a document into the ADF.
- 2 The job will be received immediately.

**Detail**

*The length of time until the machine touch panel goes off can be set from Utility mode. For details, refer to "LCD Back-Light OFF" on page 11-13.*

## Controlling machine use with user authentication (machine authentication)

If machine authentication settings have been set by the administrator, this machine can only be used by users registered with machine authentication.

- ✓ When machine authentication settings have been specified, only users that enter user names and passwords registered with user authentication can use this machine.
- ✓ Contact the machine's administrator for a user name and password.
- ✓ A maximum of 100 users can be registered with machine authentication.

1 Touch [User Name].

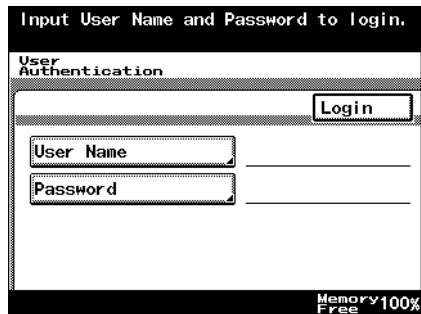

2 Type in the user name, and then touch [Enter].

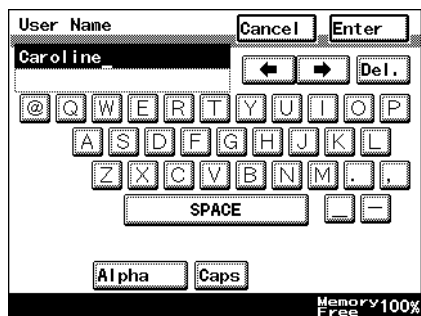

3 Touch [Password].

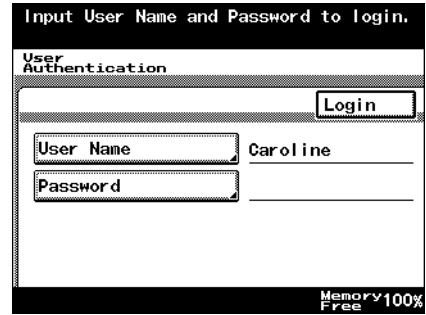

4 Type in the password, and then touch [Enter].

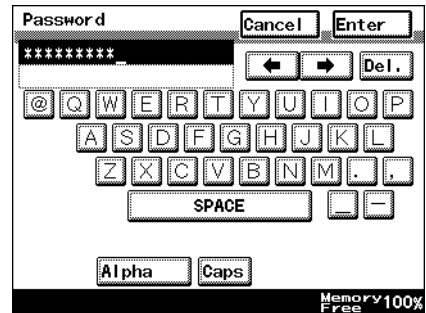

5 Touch [Login].

- If the user name or password was incorrectly entered, the input screen appears again. Type in the correct user name and password, and then touch [Login]
- Instead of touching [Login], press the [Access] key to complete the operation.

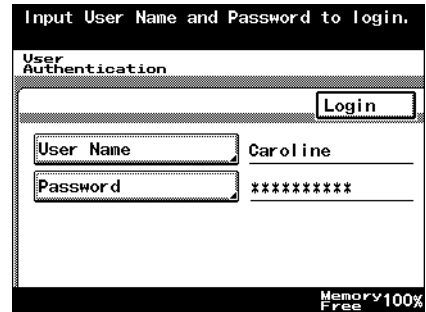

The User Authentication screen disappears, and the Basics screen appears.

6 Make copies using the desired copy settings.

- 7 When you are finished printing, press the [Access] key.  
A message appears, requesting confirmation to log off.

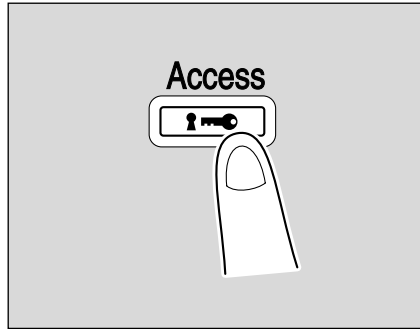

- 8 Touch [Yes], and then touch [Enter].  
The User Authentication screen appears.

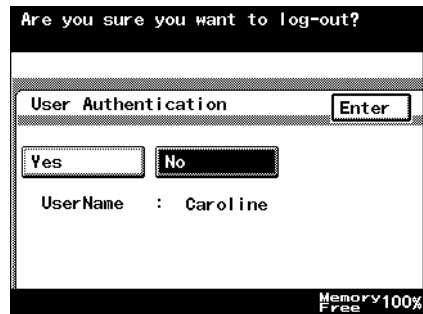

### Detail

*For details on specifying settings for machine authentication, refer to "Specifying account data settings" on page 11-31.*

*For details on logging on when external server authentication settings have been specified, refer to "Controlling machine use with user authentication (external server authentication)" on page 2-33.*

*Machine authentication settings can be specified using the User Authentication parameters in Administrator Management, available from the Utility mode. Settings should be specified by the administrator.*

**Note**

If Administrator Management settings have been specified to display a list of user names, the desired user name can be selected from a list. Touch [User List], touch the button for the desired user name to select it, and then touch [OK].

However, if "Enhance Security" has been set to "ON", [User List] does not appear.

### Controlling machine use with user authentication (external server authentication)

If external server authentication settings have been set by the network administrator, this machine can only be used by users registered with external server authentication.

- ✓ When external server authentication settings have been specified, only users who enter user names and passwords registered with external server user authentication can use this machine.
- ✓ Contact the network administrator for a user name and password.
- ✓ User names and passwords for external server authentication are registered and managed with the external server.

#### 1 Touch [User Name].

- If "Active Directory" was selected in the User Authentication screen for external server authentication and default domain name display in Administrator mode was set to "ON", [Domain Name] appears with the domain name set as the default. Touch [Domain Name] to display the list of domains registered with Active Directory, and then select the desired domain. For details on specifying settings for external server authentication, refer to "To register a user with external server authentication" on page 11-40.

- If default domain name display in Administrator mode is set to "OFF", [Domain Selection] appears with the name of the default server. Touch [Domain Selection] to display the list of domains registered with Active Directory, and then select the desired domain. However, if multiple domains are not registered, [Domain Selection] will not appear.

- 2 Type in the user name, and then touch [Enter].

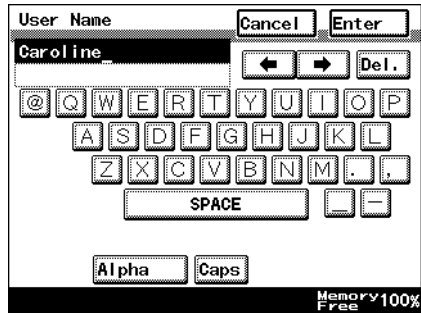

- 3 Touch [Password].

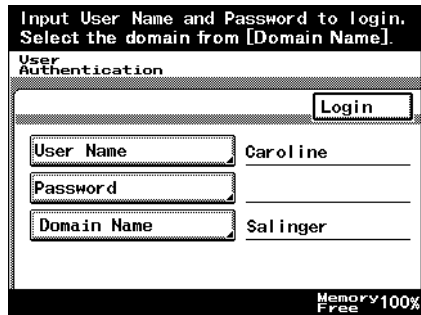

- 4 Type in the password, and then touch [Enter].

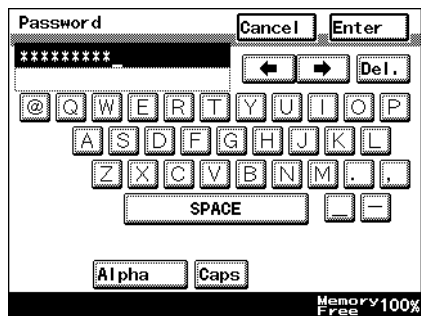

- 5 Touch [Login].
- If the user name or password was incorrectly entered, the input screen appears again. Type in the correct user name and password, and then touch [Login].
  - Instead of touching [Login], press the [Access] key to complete the operation.

The User Authentication screen disappears, and the Basics screen appears.

- 6 Make copies using the desired copy settings.

- 7 When you are finished printing, press the [Access] key.

A message appears, requesting confirmation to log off.

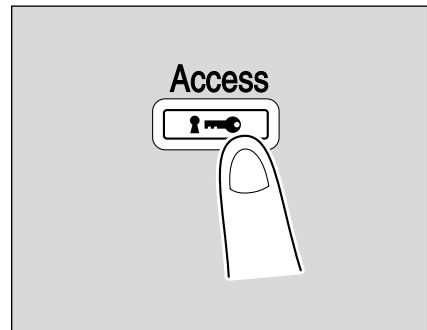

- 8 Touch [Yes], and then touch [Enter].

The User Authentication screen appears.



**Detail**

*External server authentication settings can be specified using the User Authentication parameters in Administrator mode, available from the Utility mode. Settings should be specified by the administrator.*

*For details on specifying settings for external server authentication, refer to “To register a user with external server authentication” on page 11-40.*

## Limiting user access with account track

If the account track settings have been set by the administrator, only users of registered accounts can use this machine. In addition, the number of prints produced with each account can be controlled.

This is account track.

- ✓ When account track settings have been specified, only users that enter registered account names and passwords can use this machine.
- ✓ Contact your administrator for passwords.
- ✓ A maximum of 1000 accounts can be registered.

1 Touch [Account Name].

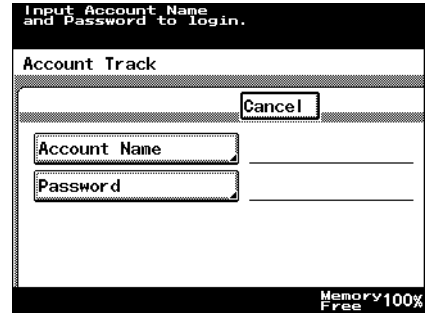

2 Type in the account name, and then touch [Enter].

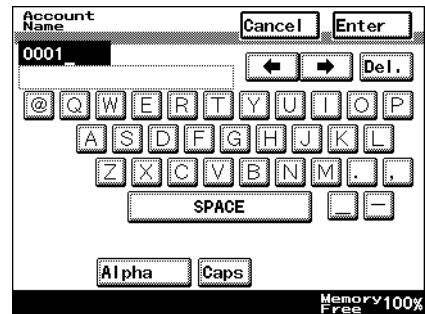

- 3 Touch [Password].

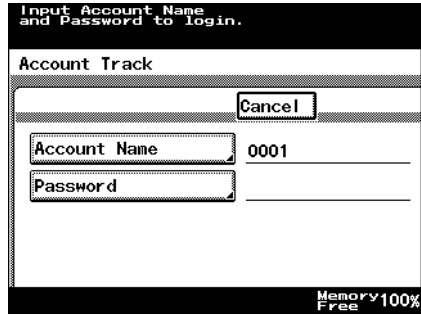

- 4 Type in the password, and then touch [Enter].

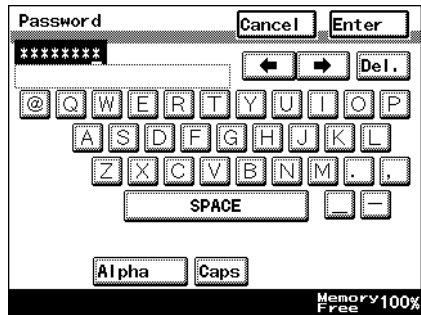

- 5 Press the [Access] key.
- If the account name or password was incorrectly entered, the input screen appears again. Type in the correct account name and password, and then press the [Access] key.

The Account Track screen disappears, and the Basics screen appears.

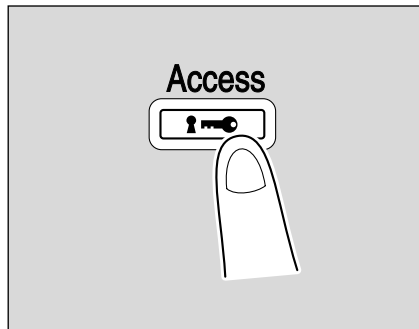

- 6 Make copies using the desired copy settings.

- 7 When you are finished printing, press the [Access] key.  
A message appears, requesting confirmation to log off.

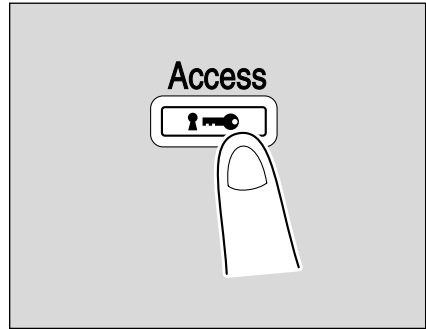

- 8 Touch [Yes], and then touch [Enter].  
The Account Track screen appears.

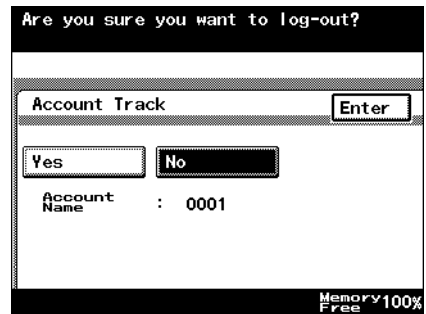

### Detail

*For details on specifying account track settings, refer to "Specifying account data settings" on page 11-31.*

*The accounts can be managed using the Account Data parameters in Administrator mode, available from the Utility mode. Settings should be specified by the administrator.*

## Controlling machine use with user authentication (external server authentication) and account track

If user authentication settings have been specified and accounts have been registered by the administrator, the use of this machine by that user can be managed with each account.

Users registered with multiple accounts can switch the account that is logged on to be able to use this machine. An example where external server authentication settings have been specified with user authentication is described below.

- ✓ Contact your administrator for passwords.
- ✓ User names and passwords for external server authentication are registered and managed with the external server.

### 1 Touch [User Name].

- For details on specifying settings for external server authentication, refer to “To register a user with external server authentication” on page 11-40.
- If “Active Directory” was selected in the User Authentication

The screenshot shows a 'User Authentication' dialog box. At the top, it says 'Input User Name and Password to login. Select the domain from [Domain Name].'. Below this is a 'Login' button. There are three input fields: 'User Name', 'Password', and 'Domain Name'. The 'Domain Name' field has 'Salinger' entered. At the bottom right, it says 'Memory Free 100%'.

- screen for external server authentication and default domain name display in Administrator mode was set to “ON”, [Domain Name] appears with the domain name set as the default. Touch [Domain Name] to display the list of domains registered with Active Directory, and then select the desired domain. For details on specifying settings for external server authentication, refer to “To register a user with external server authentication” on page 11-40.
- If default domain name display in Administrator mode is set to “OFF”, [Domain Selection] appears. Touch [Domain Selection] to display the list of domains registered with Active Directory, and then select the desired domain. However, if multiple domains are not registered, [Domain Selection] will not appear.

- 2 Type in a user name specified with external server authentication, and then touch [Enter].

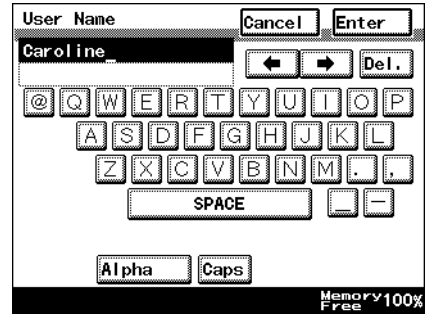

- 3 Touch [Password].

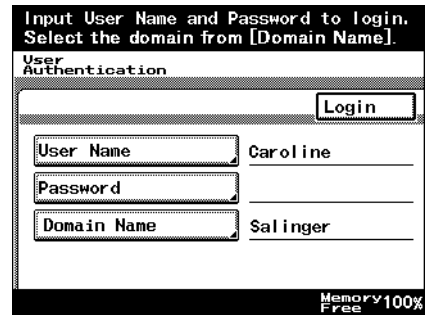

- 4 Type in the password, and then touch [Enter].

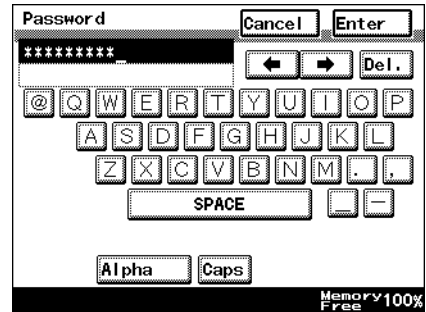

## 5 Touch [Login].

- If the user name or password was incorrectly entered, the input screen appears again. Type in the correct user name and password, and then touch [Login].
- Instead of touching [Login], press the [Access] key to complete the operation.

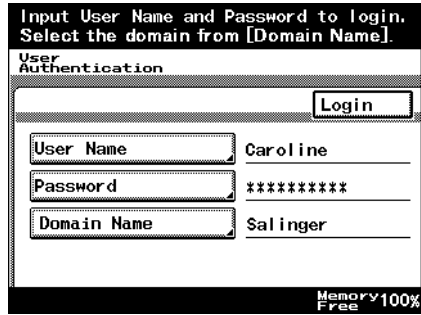

The user authentication screen disappears, and the Basics screen appears.

## 6 Touch [Account Name].

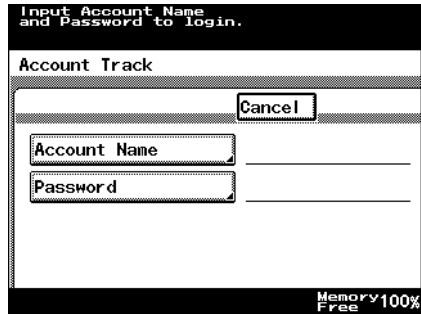

## 7 Type in the account name, and then touch [Enter].

- For details on specifying account track settings, refer to “Specifying account data settings” on page 11-31.

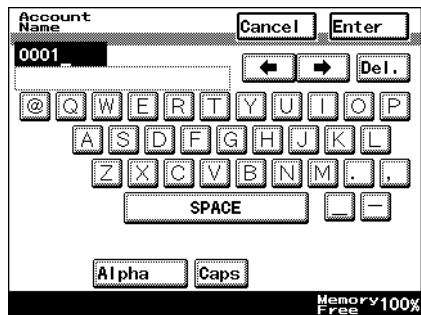

- 8 Touch [Password].

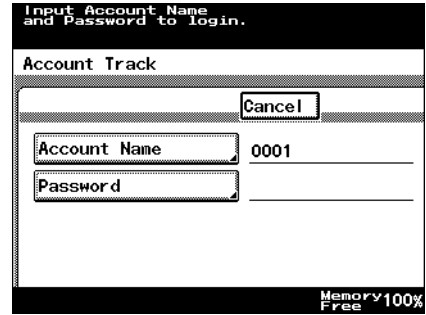

- 9 Type in the password, and then touch [Enter].

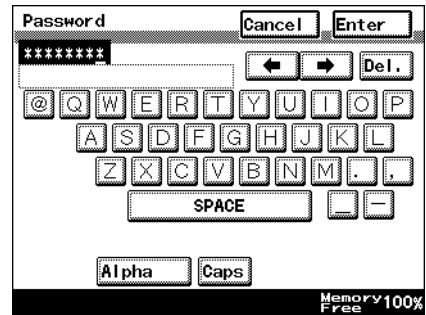

- 10 Press the [Access] key.
- If the account name or password was incorrectly entered, the input screen appears again. Type in the correct account name and password, and then press the [Access] key.

The Account Track screen disappears, and the Basics screen appears.

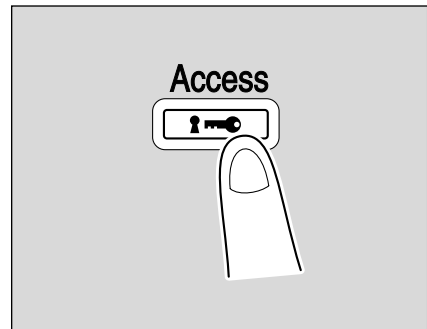

- 11 Make copies using the desired copy settings.



- 12** When you are finished printing, press the [Access] key.  
A message appears, requesting confirmation to log off.

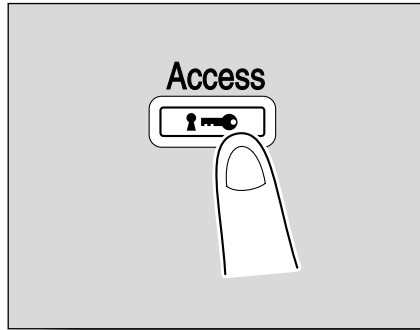

- 13** Touch [Yes], and then touch [Enter].  
The User Authentication screen appears.

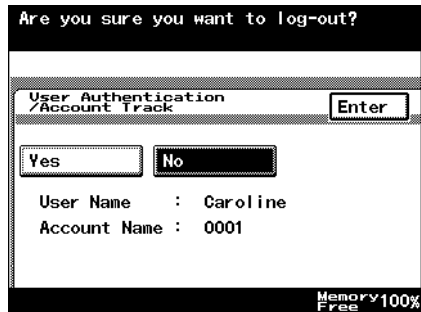

#### Detail

*External server authentication and account track settings can be specified in Administrator mode, available from the Utility mode. Settings should be specified by the administrator.*



#### Note

*If machine authentication settings have been specified with user authentication, it can be synchronized with account track.  
If user authentication and account track are synchronized, log on from the user authentication screen to display the Basics screen. For details, refer to "Controlling machine use with user authentication (machine authentication) and account track synchronized" on page 2-50.*

## Controlling machine use with user authentication (machine authentication) and account track

If user authentication settings have been specified and accounts have been registered by the administrator, the use of this machine by that user can be managed with each account.

Users registered with multiple accounts can switch the account that is logged on to be able to use this machine. An example where machine authentication settings have been specified with user authentication is described below.

- ✓ Contact your administrator for passwords.
- ✓ A maximum of 100 users can be registered with machine authentication, and a maximum of 1,000 account names can be registered.

### 1 Touch [User Name].

- Machine authentication settings can be specified using the User Authentication parameters in Administrator mode, available from the Utility mode. Settings should be specified by the administrator.
- If Administrator mode settings have been specified to display a list of user names, the desired user name can be selected from a list. Touch [User List], touch the button for the desired user name to select it, and then touch [OK]. However, if “Enhance Security” has been set to “ON”, [User List] does not appear.
- For details on specifying settings for machine authentication, refer to “To register a user with machine authentication” on page 11-42.
- For details on logging on when external server authentication settings have been specified, refer to “Controlling machine use with user authentication (external server authentication)” on page 2-33.

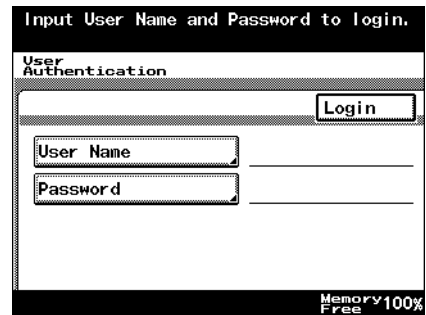

- 2 Type in a user name specified with machine authentication, and then touch [Enter].

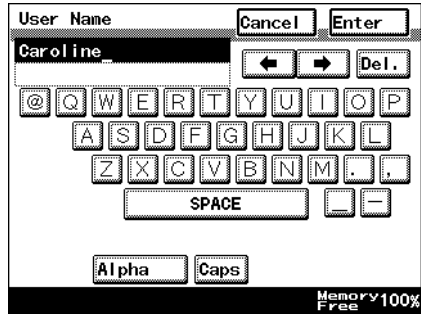

- 3 Touch [Password].

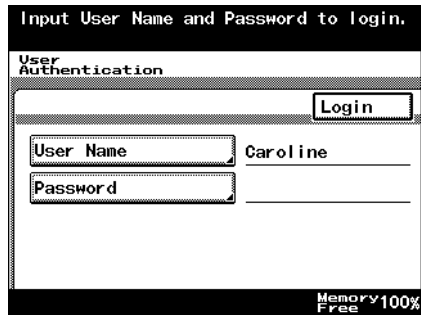

- 4 Type in the password, and then touch [Enter].

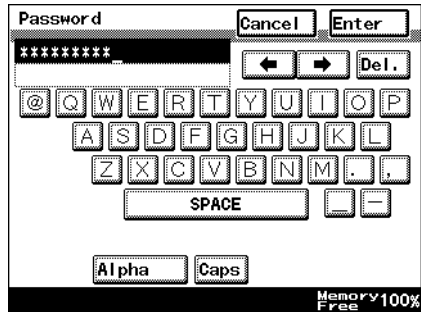

- 5 Touch [Login].
- If the user name or password was incorrectly entered, the input screen appears again. Type in the correct user name and password, and then touch [Login].
  - Instead of touching [Login], press the [Access] key to complete the operation.

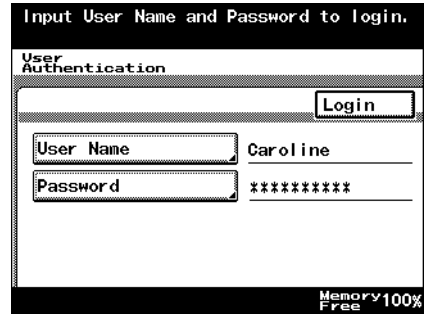

The user authentication screen disappears, and the Basics screen appears.

- 6 Touch [Account Name].

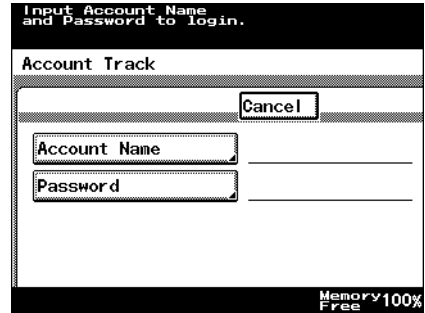

- 7 Type in the account name, and then touch [Enter].
- For details on specifying account track settings, refer to “Specifying account data settings” on page 11-31.

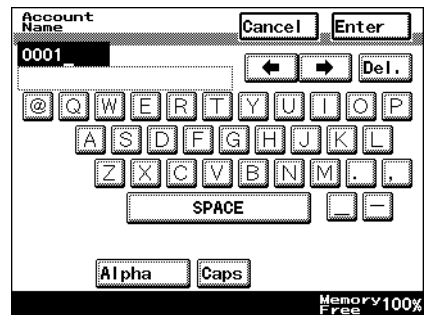

- 8 Touch [Password].

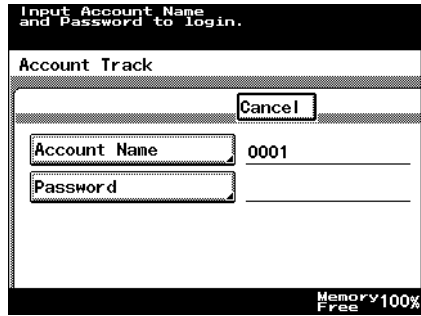

- 9 Type in the password, and then touch [Enter].

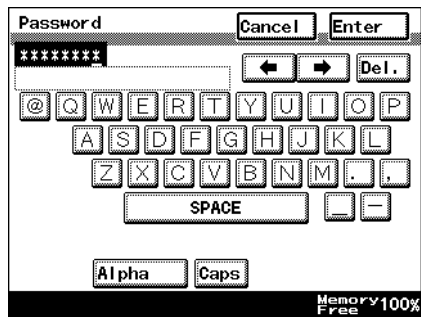

- 10 Press the [Access] key.
- If the account name or password was incorrectly entered, the input screen appears again. Type in the correct account name and password, and then press the [Access] key.

The Account Track screen disappears, and the Basics screen appears.

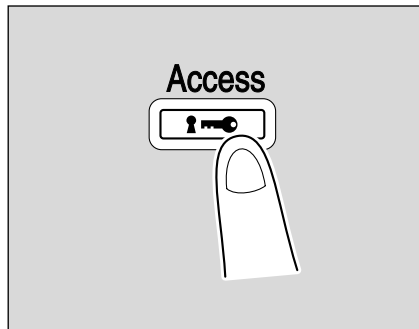

- 11 Make copies using the desired copy settings.

- 12** When you are finished printing, press the [Access] key.  
A message appears, requesting confirmation to log off.

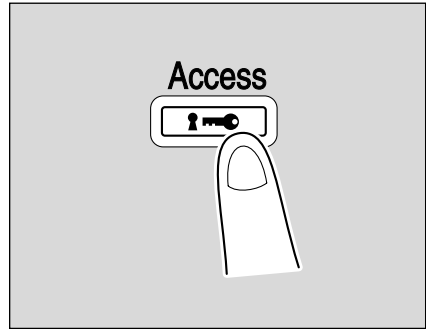

- 13** Touch [Yes], and then touch [Enter].  
The User Authentication screen appears.



#### Detail

*Machine authentication and account track settings can be specified in Administrator mode, available from the Utility mode. Settings should be specified by the administrator.*

## Controlling machine use with user authentication (machine authentication) and account track synchronized

If machine authentication settings have been specified with user authentication, the settings can be synchronized with the account track settings.

Users can log on from the User Authentication screen.

- ✓ Contact your administrator for passwords.
- ✓ A maximum of 100 users can be registered with machine authentication, and a maximum of 1,000 account names can be registered.

1 Touch [User Name].

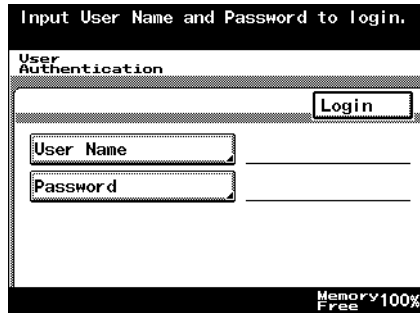

2 Type in a user name specified with machine authentication, and then touch [Enter].

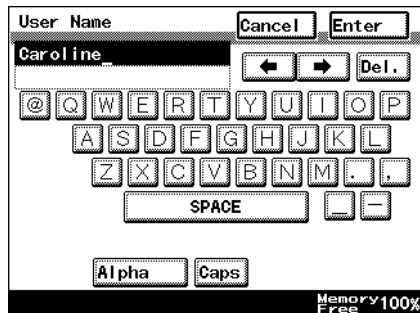

3 Touch [Password].

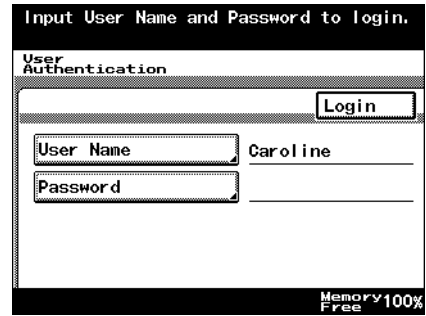

4 Type in the password, and then touch [Enter].

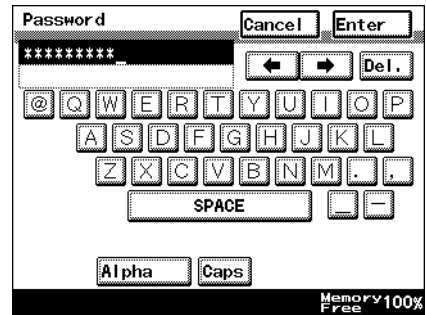

5 Touch [Login].

- If the user name or password was incorrectly entered, the input screen appears again. Type in the correct user name and password, and then touch [Login]
- Instead of touching [Login], press the [Access] key to complete the operation.
- If an account synchronized with machine authentication is renamed or deleted, the message “Your Account has been deleted. Please contact your administrator.” appears.

The User Authentication screen disappears, and the Basics screen appears.

6 Make copies using the desired copy settings.

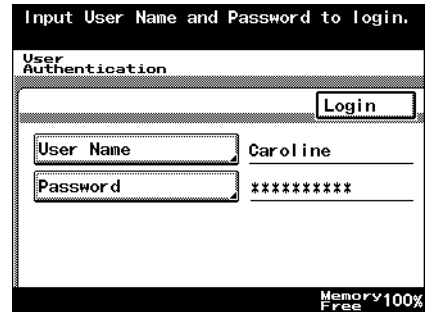



- 7 When you are finished printing, press the [Access] key.  
A message appears, requesting confirmation to log off.

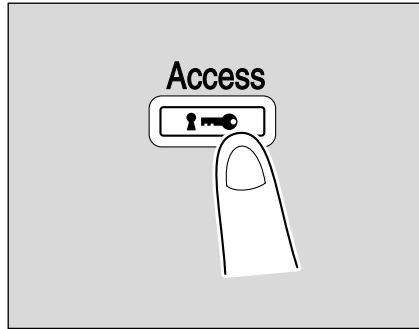

- 8 Touch [Yes], and then touch [Enter].  
The User Authentication screen appears.

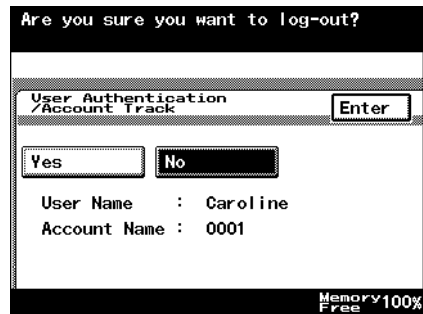

### Detail

*For details on specifying settings for machine authentication, refer to "Specifying account data settings" on page 11-31.*

*For details on logging on when external server authentication settings have been specified, refer to "Controlling machine use with user authentication (external server authentication)" on page 2-33.*

*Machine authentication settings can be specified using the User Authentication parameters in Administrator Management, available from the Utility mode. Settings should be specified by the administrator.*

**Note**

*If Administrator mode settings have been specified with machine authentication to display a list of user names, the desired user name can be selected from a list.*

*Touch [User List], touch the button for the desired user name to select it, and then touch [OK].*

*However, if "Enhance Security" has been set to "ON", [User List] does not appear.*

## 2.4 Loading paper into the 1st or 2nd tray

Follow the procedure described below to load paper into the 1st and 2nd trays or into the optional double paper feed cabinet (3rd and 4th trays).

### To load paper (1st or 2nd tray)

- 1 Pull out the paper tray to be loaded with paper.
- 2 Slide the lateral guides to fit the size of paper to be loaded.

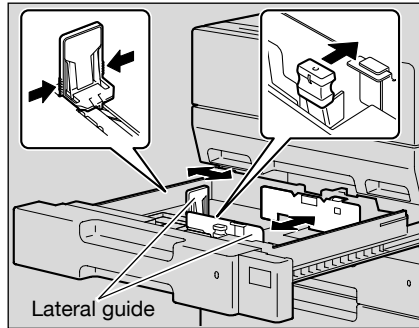

- 3** Load the paper into the tray so that the side of the paper to be printed on (the side facing up when the package was unwrapped) faces up.
- Do not load so many sheets of paper that the top of the stack is higher than the ▼ mark. A maximum of 500 sheets can be loaded.

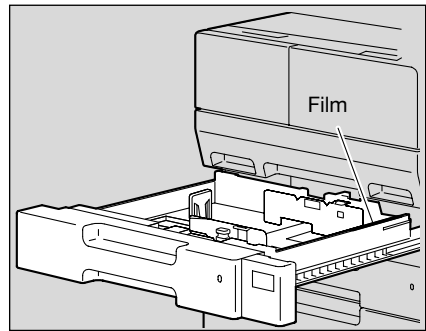
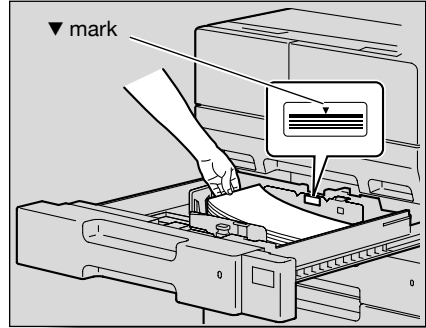

- ? How is curled paper loaded?
- Flatten the paper before loading it.

- 4** Re-adjust the lateral guides to fit the size of the paper.

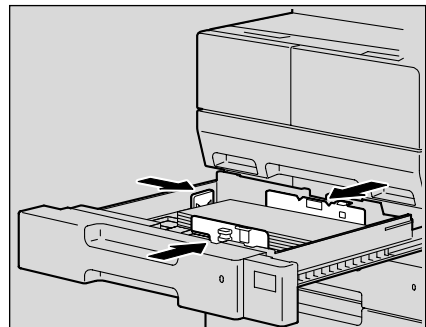

- 5** Close the paper tray.

**Reminder**

*Be careful not to touch the Film with your hands.*

*If the lateral guides are not positioned correctly for the loaded paper, the paper size will not be correctly detected. Be sure to adjust the lateral guides to the size of the loaded paper.*

**Detail**

*For details on the paper that can be loaded into the 1st and 2nd trays, refer to “Copy paper/original documents” on page 7-2.*

## 2.5 Loading paper into the LCT

### To load paper (LCT)

- ✓ If the [Power] (auxiliary power) key is turned off, even though the main power switch is on, the LCT cannot be pulled out, even after the tray release button is pressed. Be sure that the machine is turned on with the [Power] (auxiliary power) key.

- 1 Press the tray release button.

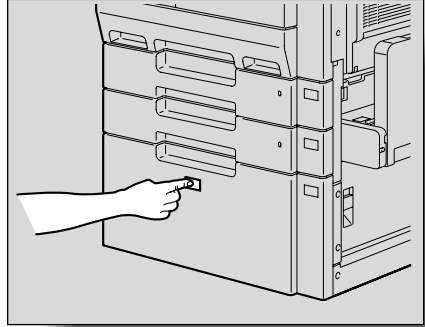

- 2 Pull out the LCT.

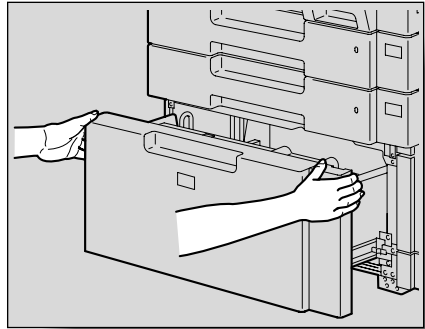

- 3 Load the paper into the right side of the LCT so that the side of the paper to be printed on (the side facing up when the package was un-wrapped) faces up.

- Do not load so many sheets that the top of the stack is higher than the ▼ mark. A maximum of 2,500 sheets can be load-ed.

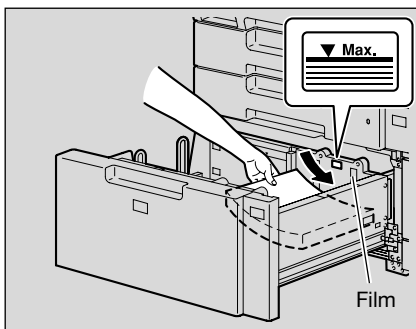

- ? How is curled paper loaded?  
→ Flatten the paper before loading it.

- 4 Load the paper into the left side of the LCT so that the side of the paper to be printed on (the side facing up when the package was un-wrapped) faces up.

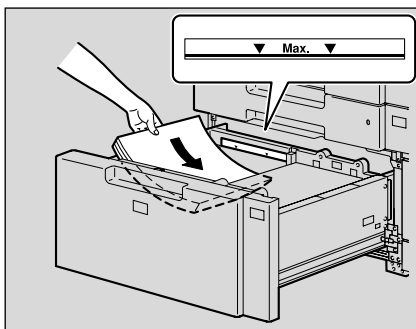

- 5 Close the LCT.



...

**Reminder**

*Be careful not to touch the Film with your hands.*

**Detail**

*For details on the paper that can be loaded into the LCT, refer to “Copy paper/original documents” on page 7-2.*



...

**Note**

*If the machine has entered Sleep mode, the LCT cannot be pulled out, even after the tray release button is pressed. Be sure to first cancel Sleep mode.*



## 2.6 Loading paper into the bypass tray

Paper can be fed manually through the bypass tray if you wish to copy onto paper that is not loaded into a paper tray, or if you wish to copy onto thick paper, postcards, envelopes, overhead projector transparencies or label sheets.

### To load paper (bypass tray)

- 1 Open the bypass tray.
  - When loading large-sized paper, pull out the tray extension.

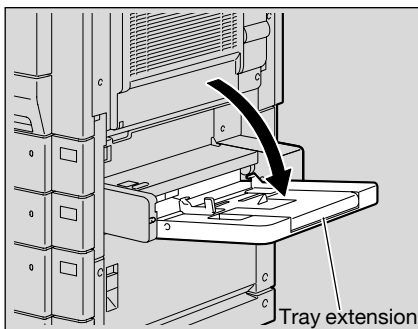

- 2 With the side to be printed on facing down, insert the paper as much as possible into the feed slot.

- 3 Slide the lateral guides to fit the size of paper being loaded.

- Do not load so many sheets that the top of the stack is higher than the ▼ mark. A maximum of 150 sheets of plain paper can be loaded.
- Slide the lateral guides firmly up against the edges of the paper.

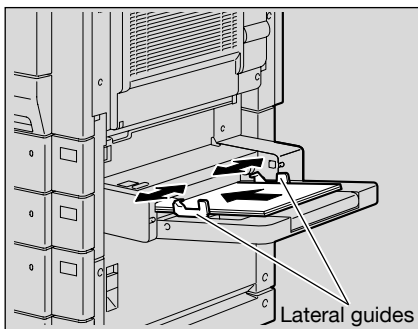

- ? How is curled paper loaded?
- Flatten the paper before loading it.

- 4 Select the paper type.

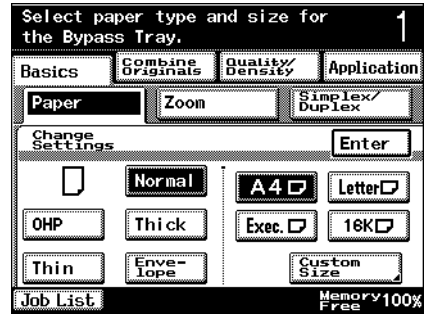



- ? What paper type is selected when label sheets are loaded?  
→ Select "Thick".

**Reminder**

*For details on the paper sizes, refer to “Copy paper” on page 7-2.*

**Reminder**

*When loading postcards, load them in the  orientation, as shown. Do not load postcards in the  orientation.*

*A maximum of 50 postcards can be loaded into the bypass tray.*

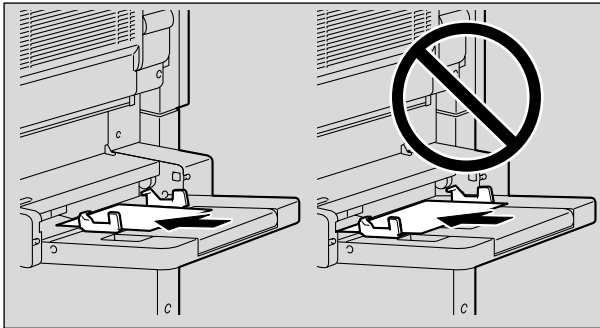
**Reminder**

*A maximum of 50 overhead projector transparencies can be loaded into the bypass tray.*

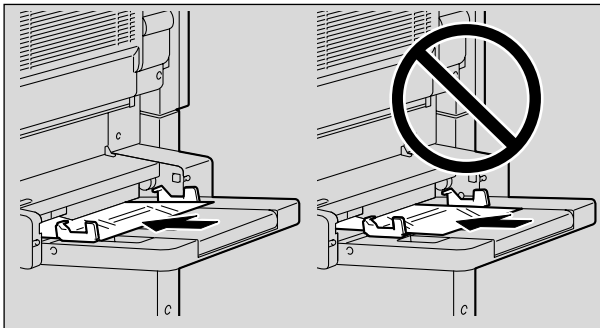



### Reminder

*Before loading envelopes, press them down to make sure that all air is removed, and make sure that the folds of the flaps are firmly pressed, otherwise the envelopes may become wrinkled or a paper misfeed may occur.*

*When loading envelopes, load them with the flap side up, as shown. If the envelopes are loaded with the flap side down, a paper misfeed may occur. The flap side of envelopes cannot be printed on.*

*A maximum of 10 envelopes can be loaded into the bypass tray.*

*After you have loaded the paper, set the paper type for the bypass tray in the touch panel.*

*If the Envelope setting was set, the loaded document is copied upside-down.*

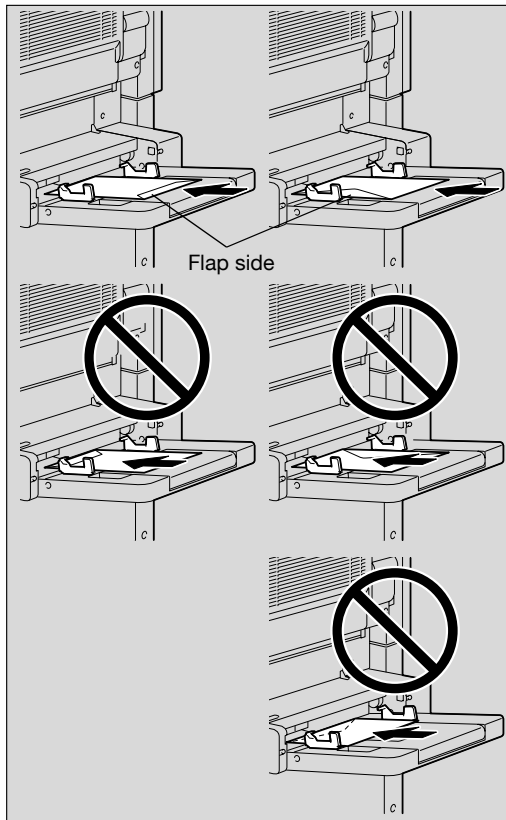

**Reminder**

*Be sure to load label sheets so that the side to be printed on faces down.*

*A maximum of 50 label sheets can be loaded into the bypass tray.*

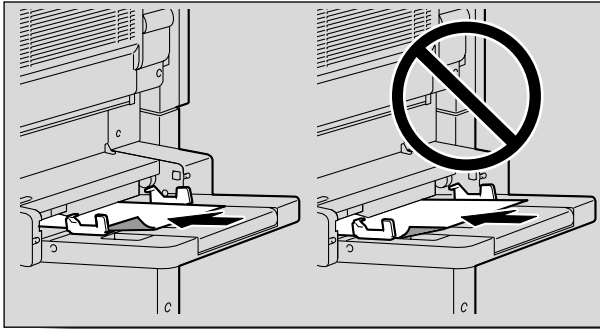
**Reminder**

*A maximum of 150 sheets of thin paper can be loaded into the bypass tray.*

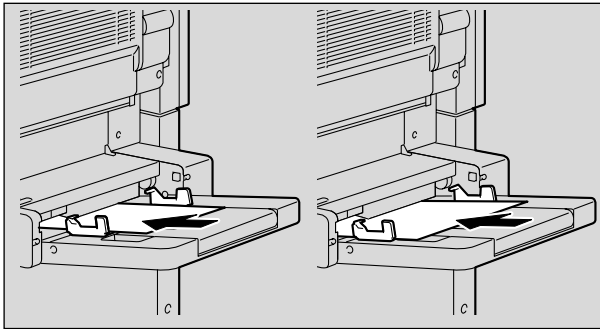
**Note**

*The image will be printed on the surface of the paper facing down when the paper is loaded into the bypass tray.*



**Detail**

*For details on specifying the paper size for the bypass tray, refer to “To specify the paper size (Change Setting)” on page 7-8.*



---



## Basic copy operation



## 3 Basic copy operation

### 3.1 General copy operation

This section contains information on the general operation for making copies.

The following procedure describes how to copy a single-sided document using basic copy operations.



#### Note

*Some settings cannot be used together.*

*For details on the settings that cannot be combined, refer to “Operations that cannot be combined” on page 3-5.*

#### To make a copy

- 1 Press the [Copy] key to display the Basics screen in Copy mode.
- 2 Position the document to be copied.
  - For details on positioning the document, refer to “Feeding the document” on page 3-8.

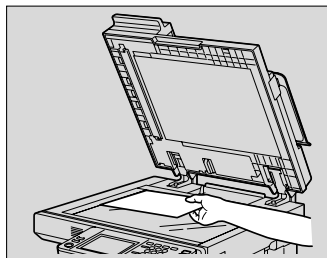
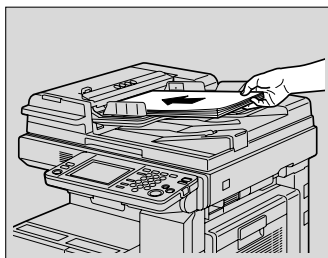

### 3 Specify the desired copy settings.

- The factory default settings for this machine are listed below.

Paper: Auto Paper

Zoom: ×1.000 (Full size)

Simplex/Duplex: 1 →

1

Quality/Density: Text

- For details on specifying document settings, refer to “Specifying document settings” on page 3-16.
- For details on selecting a paper source setting, refer to “Selecting a Paper setting” on page 3-24.
- For details on specifying a Zoom setting, refer to “Specifying a Zoom setting” on page 3-27.
- For details on selecting a Simplex/Duplex setting, refer to “Selecting single-/double-sided settings for originals and copies” on page 3-39.
- For details on selecting the quality of the document and the copy density, refer to “Specifying document quality/density settings” on page 3-43.
- For details on specifying combined copy settings, refer to “Selecting a Combine Originals setting” on page 3-46.
- For details on specifying Finishing settings, refer to “Selecting finishing for copies” on page 3-50.
- For details on selecting the binding setting, refer to “Creating booklet copies (“Booklet” function)” on page 8-22.
- For details on specifying settings for the Application functions, refer to “Application functions” on page 8-2.



### 4 Using the keypad, type in the desired number of copies.

- If the number of copies was incorrectly entered, press the [C] (clear) key in the keypad, and then specify the correct number of copies.

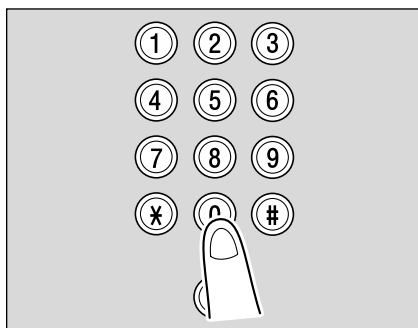

**5** Press the [Start] key.

- To stop the copy operation being performed, press the [Stop] key. For details, refer to “Stopping/deleting a job” on page 3-63.
- The next copy operation can be queued while a copy operation is being performed. For details, refer to “Scanning the next document during printing (reserving a copy job)” on page 3-61.

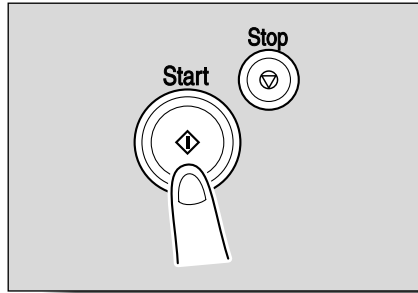
**Note**

*If the optional hard disk drive is installed, [Save in User Box] appears in the Copy mode screen. If copies are made with “Save in User Box” selected, the contents of the copied documents are saved in boxes.*

*For details on boxes, refer to the User’s Guide [Box Operations].*

**Detail**

*A function other than a copy function cannot be selected while pages are being scanned for copying or while copying is paused.*

## 3.2 Operations that cannot be combined

Certain copy settings cannot be used together.

Specifying settings that cannot be combined will result in one of the following.

- The setting specified last is given priority. (The setting specified first is canceled.)
- The setting specified first is given priority. (A warning message appears.)



### Note

*Depending on the combined operations and the selected paper type, some settings that can be specified may not be applied.*

### Operations where the setting specified last is given priority

The procedure for setting the “Book Copy” function after selecting the “4 in 1” setting is described below.

- 1 Select the “4 in 1” setting.



- 2 Set the “Book Copy” function.

The “4 in 1” setting is automatically canceled, and the “Book Copy” function is set.

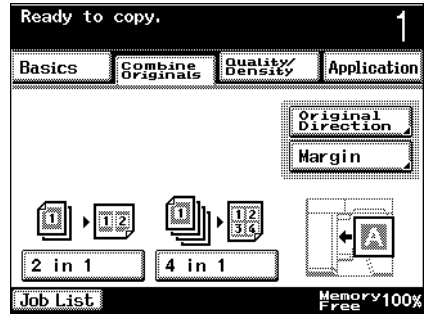
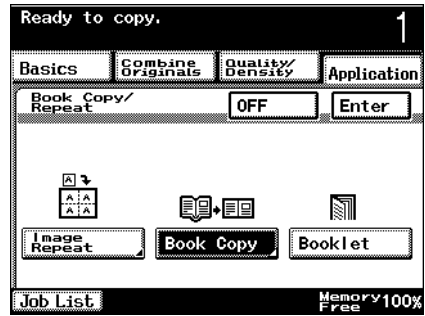

### Operations where the setting specified first is given priority

If a warning message appears, indicating that settings cannot be combined, those settings cannot be specified together.

The procedure for selecting the “Corner Staple” setting after setting the “Booklet” function is described below.

- 1 Set the “Booklet” function.

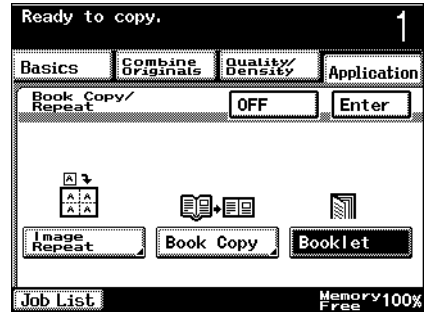

- 2 Select the “Corner Staple” setting.

The message “This mode is not available with Booklet.” appears and the “Corner Staple” setting cannot be selected.

The “Booklet” function remains selected and the “Corner Staple” setting is canceled.

To select the “Corner Staple” setting, cancel the “Booklet” function, and then select the “Corner Staple” setting.

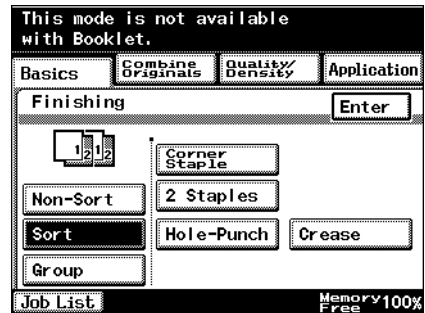

### 3.3 Feeding the document

The document can be loaded into the optional ADF or positioned on the original glass.

Document feed method	Features
Using the ADF	By using the ADF, a multi-page document can be fed automatically, one page at a time. This feed method can also be used to automatically scan double-sided documents.
Using the original glass	Place the document directly on the original glass so that it can be scanned. This method is best with books and other documents that cannot be fed through the ADF.

#### To load the document into the ADF

- ✓ Do not load documents that are bound together, for example, with paper clips or staples.
- ✓ For details on the types of documents that can be loaded into the ADF, refer to “Original documents” on page 7-17.
- ✓ Do not load more than 80 sheets or so many sheets that the top of the stack is higher than the ▼ mark, otherwise a document misfeed or damage to the document or machine may occur. However, a document that exceeds 80 pages can be scanned in separate batches. For details, refer to “Scanning a document in separate batches (“Separate Scan” setting)” on page 3-12.
- ✓ If the document is not loaded correctly, it may not be fed in straight or a document misfeed or damage to the document may occur.

- 1 Slide the adjustable document guides to fit the size of the document.

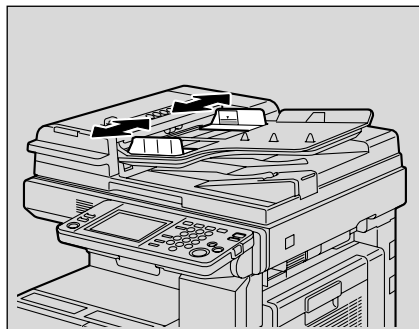

**2** Load the document face up in the document feed tray.

- Load the document pages so that the top of the document is toward the back or the left side of the machine.

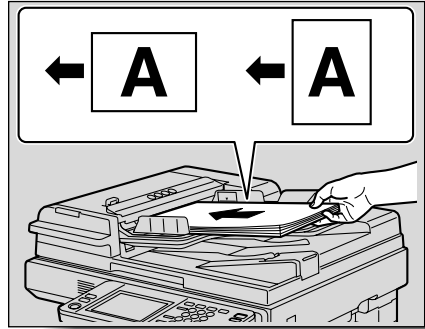

**3** Slide the adjustable document guides against the edges of the document.

- For details on loading documents of mixed sizes, refer to “Copying documents of mixed sizes (“Mixed Original” setting)” on page 3-16.
- For details on selecting the orientation of the document, refer to “Selecting the document orientation (Original Direction settings)” on page 3-19.
- For details on specifying the binding margin position, refer to “Selecting the position of the binding margin (Margin settings)” on page 3-21.

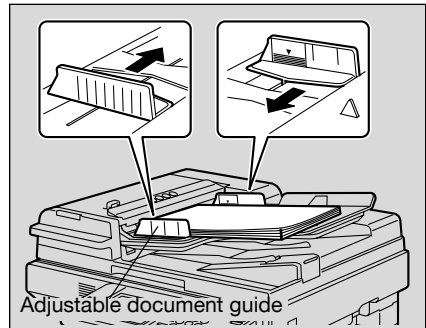



### To place the document on the original glass

- ✓ For details on the types of documents that can be placed on the original glass, refer to “Original documents” on page 7-17.
- ✓ When placing the document on the original glass, be sure to lift open the original cover or ADF at least 15°.

If the document is placed on the original glass without the original cover or ADF being lifted at least 15°, the correct document size will not be detected.

- ✓ Do not place objects weighing more than 4-1/2 lb on the original glass. In addition, do not press down extremely hard on a book spread placed on the original glass, otherwise the original glass may be damaged.
- ✓ For thick books or large objects, make the copy without closing the original cover or ADF. When a document is being scanned with the original cover or ADF open, do not look directly at the light that may shine through the original glass. Although the light that shines through the original glass is bright, it is not a laser beam and, therefore, is not as dangerous.

- 1 Lift open the original cover or ADF.
- 2 Position the document face down onto the original glass.
  - Load the document pages so that the top of the document is toward the back or the left side of the machine.

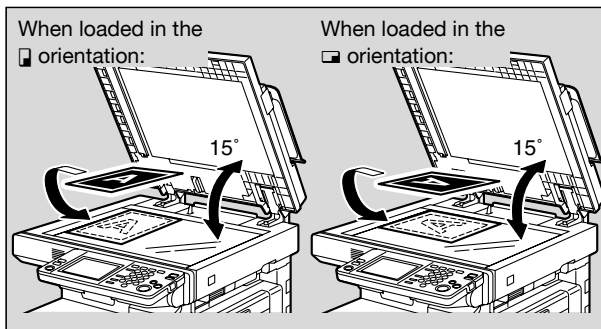

3 Align the document with the  mark in the back-left corner of the document scales.

- For details on selecting the orientation of the document, refer to “Selecting the document orientation (Original Direction settings)” on page 3-19.
- For details on specifying the binding margin position, refer to “Selecting the position of the binding margin (Margin settings)” on page 3-21.
- For transparent or translucent documents, place a blank sheet of paper of the same size as the document over the document.

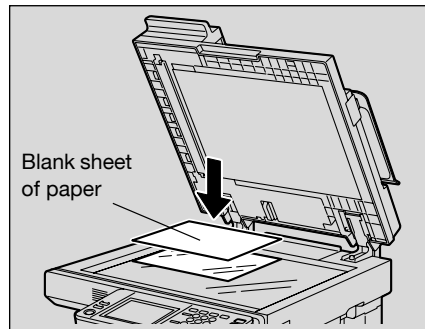
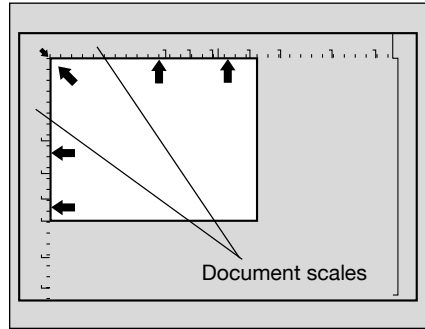

- For bound documents spread over two facing pages, such as a book or magazine, position the top of the document toward the back of this machine and align the spine of the document with the book mark in the document scale, as shown.
- For details on copying books, refer to “Producing separate copies of each page in a page spread (“Book Copy” function)” on page 8-18.

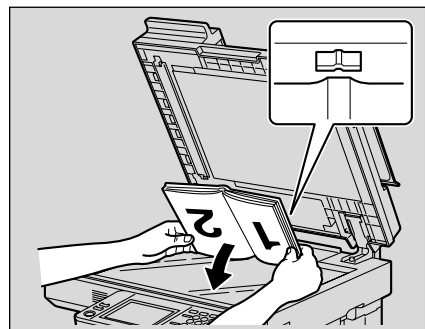

4 Close the original cover or ADF.

### Scanning a document in separate batches (“Separate Scan” setting)

A large document can be divided and continuously scanned in a number of batches.

A maximum of 80 document pages can be loaded into the ADF at one time. However, by copying with the “Separate Scan” setting, a document that exceeds 80 pages can be scanned and treated as a single copy job. In addition, the scanning location can be switched between the original glass and the ADF during the scanning operation.

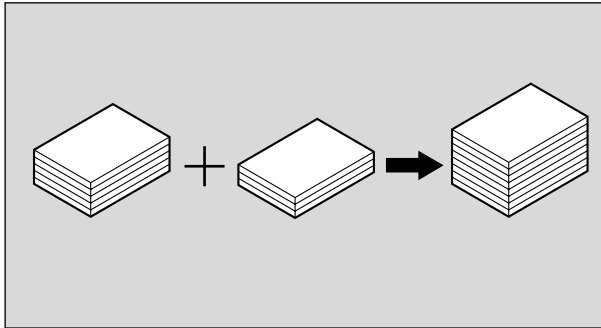

- 1 In the Application screen, touch [Separate Scan].
  - To cancel the “Separate Scan” setting, touch [Separate Scan] again to deselect it.

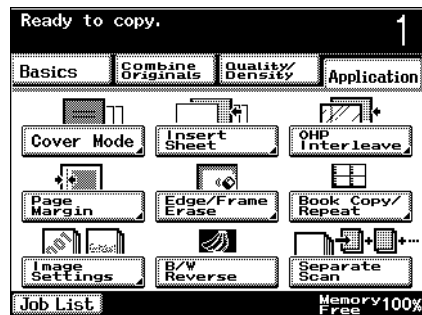

- 2 Load the first batch of the document, and then press the [Start] key. Scanning begins.

The message “To continue scanning, replace original and press Start.” appears.

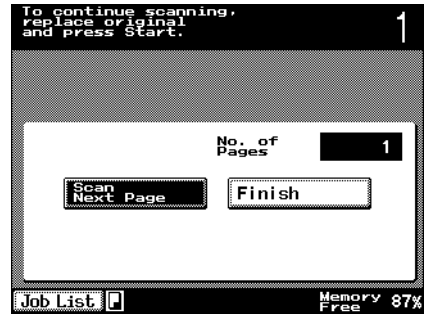

- Load the next batch of the document, and then press the [Start] key.
- If the document cannot be loaded into the ADF, place it on the original glass. For details on the types of documents that can be loaded into the ADF, refer to “Original documents” on page 7-17.
- Repeat step 2 until all pages of the document have been scanned. The amount of memory available can be checked beside “Memory Free” in the lower-right corner of the Basics screen.
- To delete the scanned image, press the [Stop] key, and then delete the job. For details, refer to “Stopping/deleting a job” on page 3-63. In addition, the job can be deleted from the Job List screen. For details, refer to “To delete a job” on page 4-25.

- 3 After all document pages have been scanned, touch [Finish].
- 4 Press the [Start] key.

### Scanning a multi-page document from the original glass

When making double-sided or combined copies using the original glass, place each page of a multi-page document on the original glass to scan it. The following procedure describes how to place single-sided document pages on the original glass to make double-sided copies.

- 1 Lift open the original cover or ADF.
- 2 Position the first page or the first side of the document face down onto the original glass.
  - For details on positioning the document, refer to “To place the document on the original glass” on page 3-10.

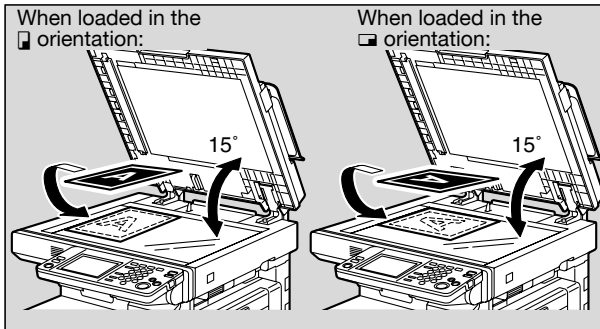

- 3 Close the original cover or ADF.
- 4 In the Basics screen, touch [Simplex/Duplex].  
The Simplex/Duplex screen appears.

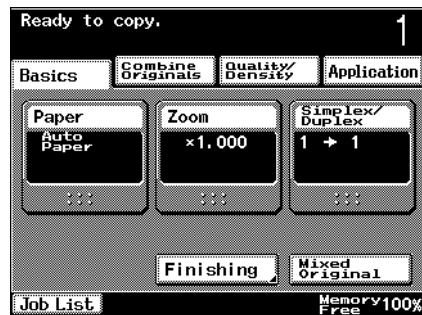

- 5 Touch [Single-Sided] under “Original” and [Double-Sided] under “Copy”.



- 6 Press the [Start] key. Scanning begins.
- The message “To continue scanning, replace original and press Start.” appears.

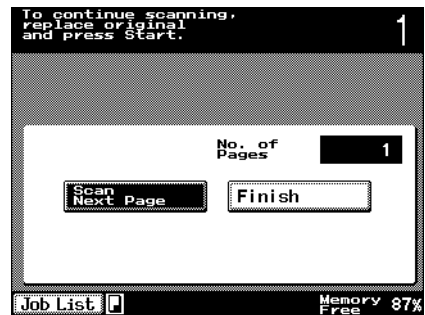

- 7 Position the second page or second side of the document onto the original glass, and then press the [Start] key.
- To scan the remaining pages in the document, repeat steps 5 through 7.
- 8 After all document pages have been scanned, touch [Finish].
- 9 Press the [Start] key.

## 3.4 Specifying document settings

The following procedure describes how to specify the type of document to be copied.

### Copying documents of mixed sizes (“Mixed Original” setting)

Documents of different sizes can be loaded together into the ADF to be fed and scanned one by one automatically.

Mixed originals paper sizes

The following chart shows the possible combinations of standard-sized paper that can be used with the “Mixed Original” setting.

Maximum Document Width* <sup>1</sup> → ↓ Document Size* <sup>2</sup>	11 × 17 ☐	Letter ☐	Legal ☐	Letter ☐	5-1/2 × 8-1/2 ☐	5-1/2 × 8-1/2 ☐
11 × 17 ☐	○	○	—	—	—	—
Letter ☐	○	○	—	—	—	—
Legal ☐	○	○	○	○	○	—
Letter ☐	○	○	○	○	○	—
5-1/2 × 8-1/2 ☐	—	—	○	○	○	—
5-1/2 × 8-1/2 ☐	—	—	—	—	—	○

○: Possible

—: Not possible

### To copy documents with the “Mixed Original” setting

- ✓ The possible combinations of document sizes differ depending on the widest document loaded (position of the adjustable document guides of the ADF).
- ✓ \*<sup>1</sup> Indicates the width of the widest document size of the mixed originals (width of the adjustable document guides of the ADF).
- ✓ \*<sup>2</sup> Indicates document sizes that can be specified together with the maximum document width.

- 1 Slide the adjustable document guides to fit the size of the largest page.

- 2 Arrange the document pages so that the side to be copied (first page) faces up, as shown in the illustration.

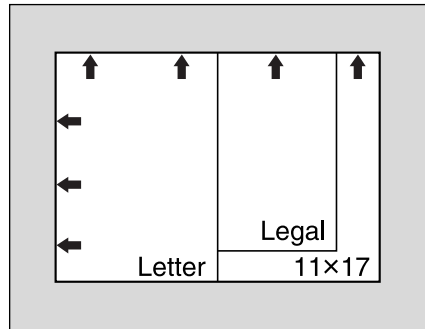

- 3 Load the document face up in the document feed tray. Slide the adjustable document guides against the edges of the document.

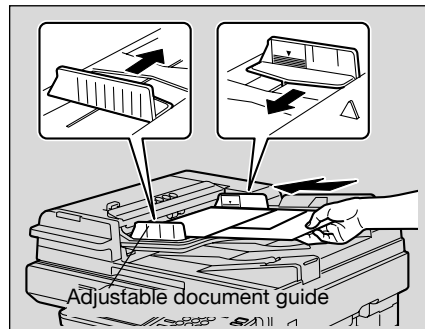

- Load the document pages into the ADF so that the top of the pages is toward the back or the left side of the machine.
- If the document is not loaded correctly, it may not be fed in straight or a document misfeed or damage to the document may occur.

- 4 In the Basics screen, touch [Mixed Original].

- To cancel the “Mixed Original” setting, touch [Mixed Original] again to deselect it.

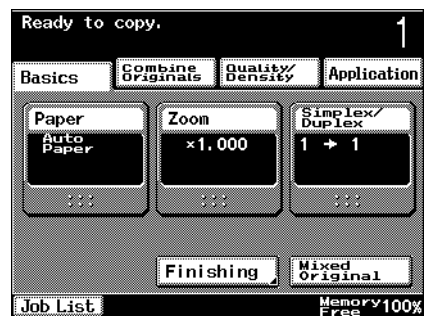



- 5 Press the [Start] key.

Scanning begins.

**Detail**

*Do not load more than 80 sheets or so many sheets that the top of the stack is higher than the ▼ mark, otherwise a document misfeed or damage to the document or machine may occur. However, a document that exceeds 80 pages can be scanned in separate batches. For details, refer to “Scanning a document in separate batches (“Separate Scan” setting)” on page 3-12.*

**Note**

*If the “Mixed Original” setting was selected, double-sided copying cannot be selected.*

### Selecting the document orientation (Original Direction settings)

When copying double-sided documents, making double-sided copies, or using a combined copy setting, specify the document orientation, otherwise the copies may not be printed in the correct page order or correct front and back page arrangement.



#### Note

*The factory default setting is the first setting (with the top of the document at the top (toward the back of the machine)).*

#### Document Loading Orientation

Using the ADF	Using the original glass	Icon	Description
			Select this setting for a document loaded with the top toward the back of this machine.
			Select this setting for a document loaded with the top to the left side of this machine.

### To select an Original Direction setting

- ✓ For details on positioning the document, refer to “Feeding the document” on page 3-8.

1 Position the document to be copied.

2 In the Basics screen, touch [Combine Originals].

The Combine Originals screen appears.



3 Touch [Original Direction].

The Original Direction screen appears.

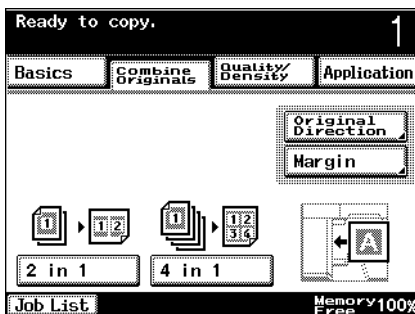

4 Select the document orientation. Touch the button for the orientation of the loaded document, and then touch [Enter].

- To cancel the Original Direction setting, touch [OFF].



### Selecting the position of the binding margin (Margin settings)



When making single-sided copies of double-sided documents with a binding margin, or when making double-sided copies of single-sided documents with a binding margin, the position of the binding margin for the even-numbered pages can be adjusted.



#### Note

As the factory default, "OFF" is selected for the Margin setting.

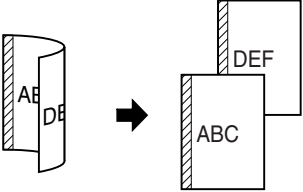
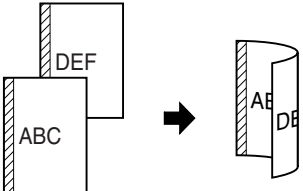
#### Document Binding Margin Position

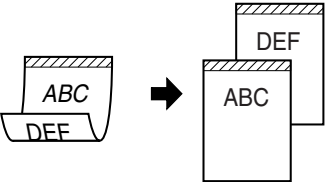
Icon	Description
	<p>Select this setting if the document that is loaded has a binding margin on the left.</p> <ul style="list-style-type: none"> <li>Single-sided copies of double-sided documents</li> </ul>  <ul style="list-style-type: none"> <li>Double-sided copies of single-sided documents</li> </ul> 
	<p>Select this setting if the document that is loaded has a binding margin at the top.</p> <ul style="list-style-type: none"> <li>Single-sided copies of double-sided documents</li> </ul> 

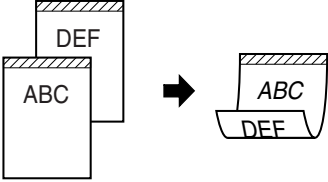
Icon	Description
	<ul style="list-style-type: none"><li data-bbox="348 172 770 193">• Double-sided copies of single-sided documents</li></ul> 

### To select a Margin setting

- ✓ For details on positioning the document, refer to “Feeding the document” on page 3-8.

- 1 Position the document to be copied.
  - When loading a document with a binding margin, position the top of the document toward the back of the machine.

- 2 In the Basics screen, touch [Combine Originals].

The Combine Originals screen appears.



- 3 Touch [Margin].

The Margin screen appears.

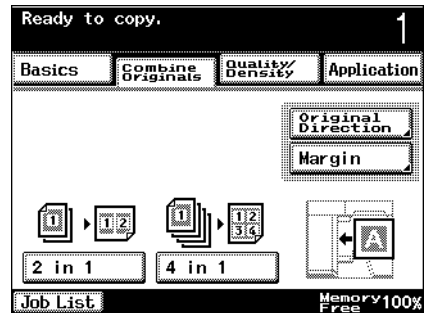

- 4 Select the binding margin position. Touch the button for a left binding margin or for a top binding margin, and then touch [Enter].

- To cancel the Margin setting, touch [OFF].

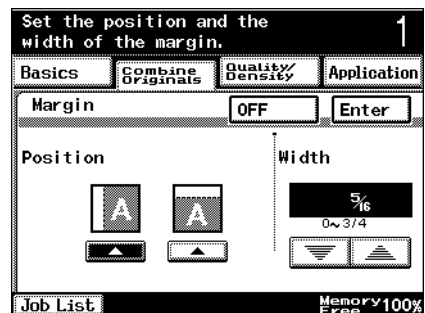

## 3.5 Selecting a Paper setting

The paper size can be selected automatically according to the document size or it can be specified manually. Specify the paper size according to the corresponding procedure, depending on the desired copy settings.



### Note

*The factory default setting is "Auto Paper Select".*

*As a factory default, the "Auto Zoom" setting and the "Auto Paper Select" setting cannot both be selected at the same time. If the "Auto Paper Select" setting is selected while the "Auto Zoom" setting was selected, the Zoom setting "x1.0" is selected.*

*However, the software switch settings can be used to allow the "Auto Zoom" setting and the "Auto Paper Select" setting to be selected at the same time. For details on the software switch settings, refer to "Specifying software switch settings (machine functions)" on page 11-50.*

### Automatically selecting the paper size ("Auto Paper Select" setting)

The size of the loaded document is detected, and copies are produced using paper of the same size.

If the "x1.0" Zoom setting was specified, paper of the same size as the document is selected.

If the zoom ratio was increased or decreased, a paper size that corresponds to the specified zoom ratio is automatically selected.

- 1 In the Basics screen, touch [Paper].  
The Paper screen appears.



- 2 Touch [Auto Paper Select].

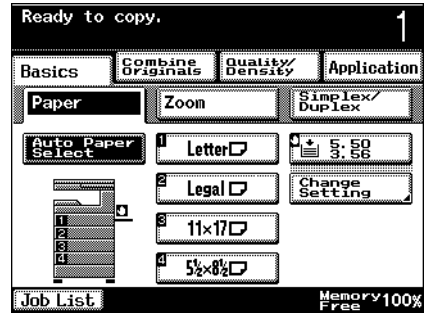

### Detail

*If the document size cannot be detected, remove the document, and then load it again.*

*If a document with an irregular size is loaded, specify the paper size manually. (Refer to “Manually selecting the desired paper size” on page 3-25.)*

### Manually selecting the desired paper size

The paper size can be specified for copying. By also selecting the “Auto Zoom” setting, the most appropriate zoom ratio is selected based on the size of the loaded document and the specified paper size. For details on the “Auto Zoom” setting, refer to “Automatically selecting the zoom ratio (“Auto Zoom” setting)” on page 3-27.

- 1 In the Basics screen, touch [Paper].  
The Paper screen appears.





- 2 Select the paper tray loaded with the desired paper.

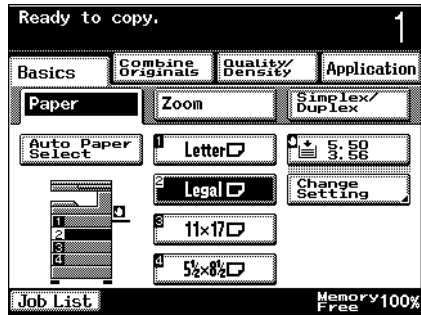

### 3.6 Specifying a Zoom setting

The zoom ratio can be set in order to make a copy on paper with a size different than the document or to enlarge or reduce the size of the copy image.

The following procedures describe how to specify the Zoom setting.



#### Note

*The factory default setting is “×1.0”.*

*As a factory default, the “Auto Zoom” setting and the “Auto Paper Select” setting cannot both be selected at the same time. If the “Auto Zoom” setting is selected while the “Auto Paper Select” setting was selected, the Paper screen appears. In the Paper screen, specify the desired Paper setting.*

*However, the software switch settings can be used to allow the “Auto Zoom” setting and the “Auto Paper Select” setting to be selected at the same time. For details on the software switch settings, refer to “Specifying software switch settings (machine functions)” on page 11-50.*

#### Automatically selecting the zoom ratio (“Auto Zoom” setting)

The most appropriate zoom ratio is automatically selected based on the size of the loaded document and the specified paper size.

- 1 In the Basics screen, touch [Zoom].  
The Zoom screen appears.



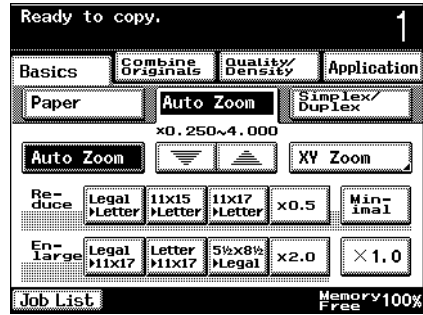

2 Touch [Auto Zoom].



### Specifying the same zoom ratio as the document (“×1.0” setting)

A copy that is the same size as the document (×1.000) is produced.

- ✓ Touch  to enlarge the zoom ratio, and touch  to reduce the zoom ratio in ×0.001 increments.

- 1 In the Basics screen, touch [Zoom].  
The Zoom screen appears.





- 2 Touch [×1.0].



### Slightly reducing the copy (“Minimal” setting)

A document image can be printed slightly smaller ( $\times 0.930$ ) than the original document size.

- ✓ The zoom ratio of the “Minimal” setting can be changed (between  $\times 0.900$  and  $\times 0.999$ ). For details on changing the zoom ratio for the “Minimal” setting or programming custom zoom ratios, refer to “Storing the desired zoom ratio” on page 3-37.
- ✓ Touch  to enlarge the zoom ratio, and touch  to reduce the zoom ratio in  $\times 0.001$  increments.

- 1 In the Basics screen, touch [Zoom].  
The Zoom screen appears.



- 2 Touch [Minimal].

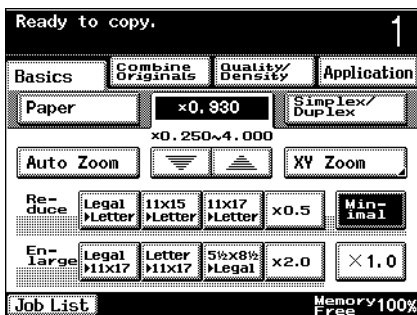



## Finely adjusting the zoom ratio

The zoom ratio can be finely increased or reduced in  $\times 0.001$  increments in order to copy at the desired size.

- 1 In the Basics screen, touch [Zoom].  
The Zoom screen appears.



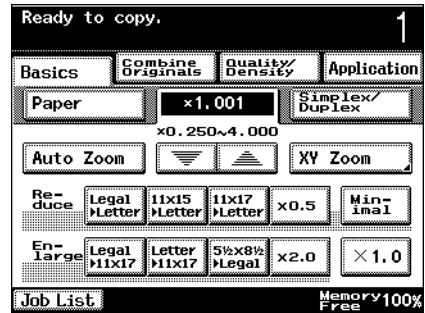

- 2 Adjust the zoom ratio.
  - Touch  to increase the zoom ratio, and touch  to reduce the zoom ratio.
  - The zoom ratio is increased or reduced in  $\times 0.001$  increments.
  - Hold down the button to change the zoom ratio in larger increments.



### Selecting a preset zoom ratio (Enlarge and Reduce settings)

The most suitable zoom ratios for copying from common standard document sizes to standard paper sizes are preset.

- ✓ Touch  to enlarge the zoom ratio, and touch  to reduce the zoom ratio in  $\times 0.001$  increments.

- 1 In the Basics screen, touch [Zoom].

The Zoom screen appears.



- 2 Touch the button for the appropriate zoom ratio according to the document and paper sizes.

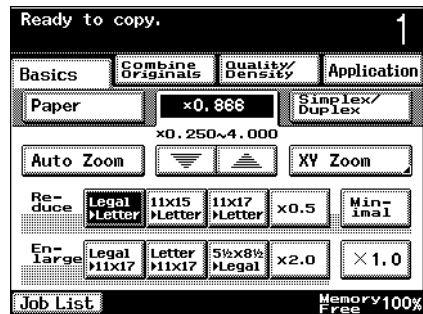

## Typing in the zoom ratio

By using the keypad, a zoom ratio between  $\times 0.250$  and  $\times 4.000$  can be typed in directly without changing the height-to-width ratio.

- 1 In the Basics screen, touch [Zoom].  
The Zoom screen appears.

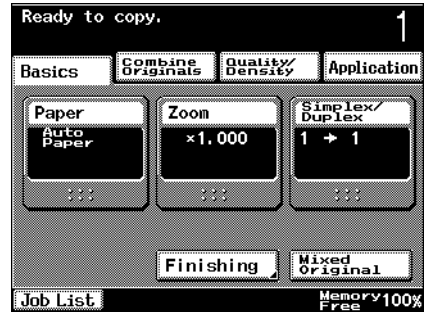

- 2 Touch [XY Zoom].  
The XY Zoom screen appears.



- 3 Using the keypad, type in the desired zoom ratio.
  - If a value outside the allowable range is specified, the message “Input Error” appears. Type a value within the allowable range.
  - If the value was incorrectly entered, press the [C] (clear) key in the keypad to erase the value, and then specify the correct value.





#### 4 Touch [Enter].

The Zoom screen appears again.



#### Detail

*The enter zoom ratio can be stored. For details on storing zoom ratios, refer to "Storing the desired zoom ratio" on page 3-37.*

### Specifying separate horizontal and vertical zoom ratios (Individual Zoom settings)

By using the keypad, separate zoom ratios can be typed in directly for the horizontal direction (between  $\times 0.250$  and  $\times 4.000$ ) and for the vertical direction (between  $\times 0.250$  and  $\times 4.000$ ).

By changing the horizontal and vertical zoom ratios, the copy image can be resized as shown in the following illustration.

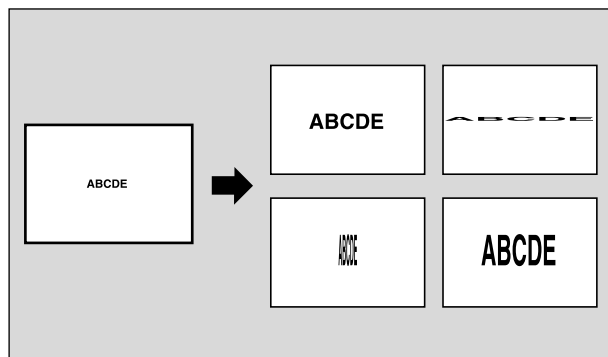

#### 1 In the Basics screen, touch [Zoom].

The Zoom screen appears.



- 2 Touch [XY Zoom].  
The XY Zoom screen appears.

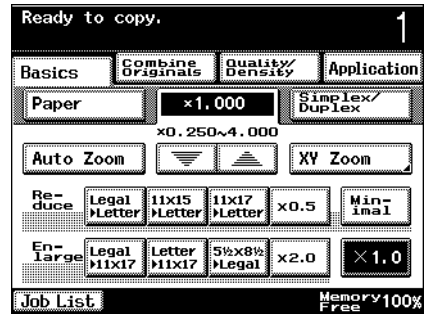

- 3 Touch [Individual Zoom].  
The Individual Zoom screen appears.



- 4 Using the keypad, type in the desired zoom ratios for side X and side Y (between  $\times 0.250$  and  $\times 4.000$ ).
- If a value outside the allowable range is specified, the message “Input Error” appears. Type a value within the allowable range.
  - If the value was incorrectly entered, press the [C] (clear) key in the keypad to erase the value, and then specify the correct value.



- 5 Touch [Enter].  
The Zoom screen appears again.

## Selecting a stored zoom ratio

Copy zoom ratios that have been stored can be recalled to be used when desired.

In addition, stored copy zoom ratios can be changed.

- ✓ Stored zoom ratios can be changed to desired zoom ratios. For details on storing zoom ratios, refer to “Storing the desired zoom ratio” on page 3-37.
- ✓ The zoom ratios  $\times 1.000$ ,  $\times 1.000$  and  $\times 0.930$  have been stored.

- 1 In the Basics screen, touch [Zoom].  
The Zoom screen appears.



- 2 Touch [XY Zoom].  
The XY Zoom screen appears.



- 3 Touch the button for the desired zoom ratio.



- 4 Touch [Enter].  
The Zoom screen appears again.

### Storing the desired zoom ratio

Two frequently used zoom ratios and the zoom ratio for the “Minimal” setting can be stored.

- ✓ The zoom ratios  $\times 1.000$ ,  $\times 1.000$  and  $\times 0.930$  have been stored. When a new zoom ratio is stored, it overwrites the zoom ratio stored with the selected button.

- 1 In the Basics screen, touch [Zoom].  
The Zoom screen appears.



- 2 Touch [XY Zoom].  
The XY Zoom screen appears.



## 3 Touch [Set Zoom].

The Set Zoom screen appears.

4 Using the keypad, type in the desired zoom ratio (between  $\times 0.250$  and  $\times 4.000$ ).

- If a value outside the allowable range is specified, the message “Input Error” appears. Type a value within the allowable range.
- If the value was incorrectly entered, press the [C] (clear) key in the keypad to erase the value, and then specify the correct value.
- To store a “Minimal” zoom ratio, type in the desired zoom ratio between  $\times 0.900$  and  $\times 0.999$ .

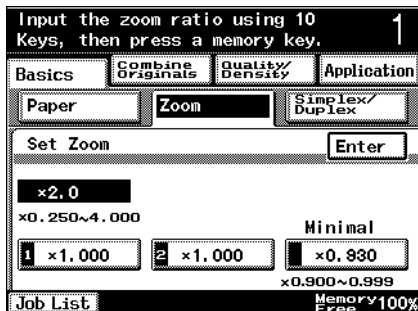

## 5 Touch the button or [Minimal] where the new zoom ratio is to be stored.

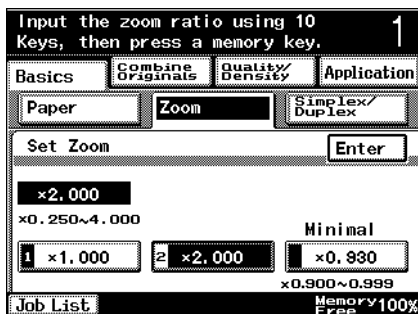





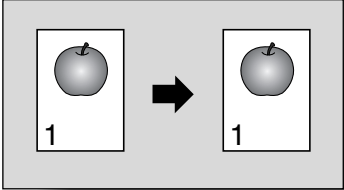

## 6 Touch [Enter].

The XY Zoom screen appears again.

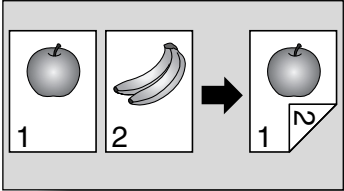
### 3.7 Selecting single-/double-sided settings for originals and copies

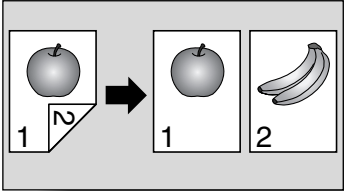
The following four combinations of the “Single-Sided” and “Double-Sided” settings are available originals and copies.

Original/copy settings	Description
<p data-bbox="239 347 482 368">Single-Sided → Single-Sided</p> 	<p data-bbox="536 347 1028 389">Select this setting to produce single-sided copies from single-sided documents.</p> 
<p data-bbox="239 641 490 662">Single-Sided → Double-Sided</p> 	<p data-bbox="536 641 1028 683">Select this setting to produce one double-sided copy from two single-sided documents.</p> 
<p data-bbox="239 935 490 956">Double-Sided → Single-Sided</p> 	<p data-bbox="536 935 1028 976">Select this setting to produce two single-sided copies from one double-sided document.</p> 

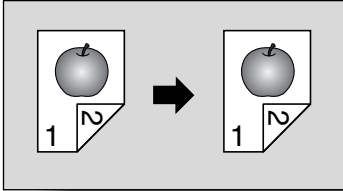
Original/copy settings	Description
<p data-bbox="194 169 454 193">Double-Sided → Double-Sided</p> 	<p data-bbox="489 169 958 212">Select this setting to produce double-sided copies from double-sided documents.</p> 

### To select single-sided copies

- ✓ As a factory default, the “Single-Sided” Original setting and the “Single-Sided” Copy setting are selected.
- ✓ If the “Double-Sided” Original setting and the “Single-Sided” Copy setting are selected, specify the position of the binding margin and the loading orientation for the document, otherwise the copies will not be printed as desired. For details on specifying the position of the binding margin, refer to “Selecting the position of the binding margin (Margin settings)” on page 3-21. For details on specifying the document orientation, refer to “Selecting the document orientation (Original Direction settings)” on page 3-19.
- ✓ For details on using the original glass to scan multiple document pages, refer to “Scanning a multi-page document from the original glass” on page 3-14.

- 1 In the Basics screen, touch [Simplex/Duplex].  
The Simplex/Duplex screen appears.



- 2 Select the single-sided copy settings according to the loaded document.
- For a single-sided document, touch [Single-Sided] under “Orig.” and [Single-Sided] under “Copy”.
  - For a double-sided document, touch [Double-Sided] under “Orig.” and [Single-Sided] under “Copy”.

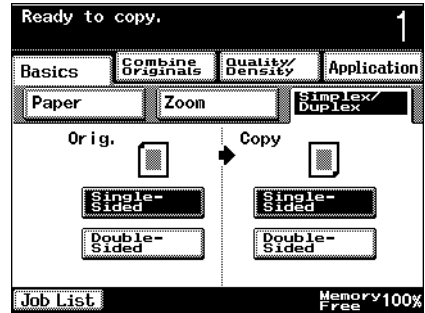

### To select double-sided copies

- ✓ As a factory default, the “Single-Sided” Original setting and the “Single-Sided” Copy setting are selected.
- ✓ If the “Double-Sided” Copy setting is selected, specify the position of the binding margin and the loading orientation for the document, otherwise the copies will not be printed as desired.
  - For details on specifying the position of the binding margin, refer to “Selecting the position of the binding margin (Margin settings)” on page 3-21.
  - For details on specifying the document orientation, refer to “Selecting the document orientation (Original Direction settings)” on page 3-19.
- ✓ For details on using the original glass to scan multiple document pages, refer to “Scanning a multi-page document from the original glass” on page 3-14.

- 1 In the Basics screen, touch [Simplex/Duplex].  
The Simplex/Duplex screen appears.





2 Select the double-sided copy settings according to the loaded document.

- For a single-sided document, touch [Single-Sided] under “Orig.” and [Double-Sided] under “Copy”.
- For a double-sided document, touch [Double-Sided] under “Orig.” and [Double-Sided] under “Copy”.

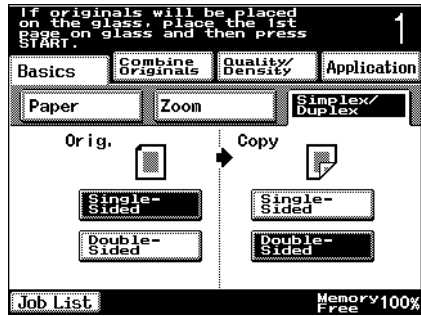





### 3.8 Specifying document quality/density settings



Select the setting for the text and image type of the document to better adjust the copy quality.

The following Quality/Density settings are available.

#### Document Quality Types

Icon	Description
 Text	Select this setting when copying documents containing only text. The edges of copied text are reproduced with sharpness, providing text that is easy to read.
 Text & Photo	Select this setting when copying printed documents containing both text and images, such as pamphlets or catalogs.
 Photo	Select this setting when copying printed documents, such as pamphlets or catalogs. Select this setting to produce better reproductions of half-tone document images (photographs, etc.) that cannot be reproduced with the usual copy settings.
 Dot Matrix	Select this setting when copying documents containing only text, where some of the text appears faint (such as that written with a pencil). The copied text is reproduced so that it is darker, making it easier to read.

#### Density Adjustment

Icon	Description
  	The density can be adjusted to one of nine levels. Each time [Dark] is touched, the density is darkened by one level. Each time [Light] is touched, the density is lightened by one level.
	Select this setting to automatically adjust the density according to the document that is loaded.

### Specifying a document quality setting

- ✓ The factory default setting is “Text & Photo”.
- ✓ For details on positioning the document, refer to “Feeding the document” on page 3-8.

1 Position the document to be copied.

2 In the Basics screen, touch [Quality/Density].

The Quality/Density screen appears.



3 Touch the button for the quality setting most appropriate for the loaded document.

- For a document that contains only text, touch [Text].
- For a document that contains both text and photos, touch [Text & Photo].
- For a document that contains photos, touch [Photo].
- For a document that contains faint text, touch [Dot Matrix].



### Adjusting the Copy Density (Density settings)

- ✓ The default setting is the middle of the five levels. When the “Auto” setting is selected, the “Std.” Density setting is set.
- ✓ The default Density setting and the density selected when the “Auto” setting is selected can be changed from the Utility mode. For details, refer to “Default Copy Output Levels” on page 11-14.

- 1 In the Basics screen, touch [Quality/Density].  
The Quality/Density screen appears.



- 2 Select the desired Density setting.
  - Each time [Light] or [Dark] is touched, the density is lightened or darkened by one level.
  - Touch [Auto] to automatically adjust the density according to the document that is loaded.

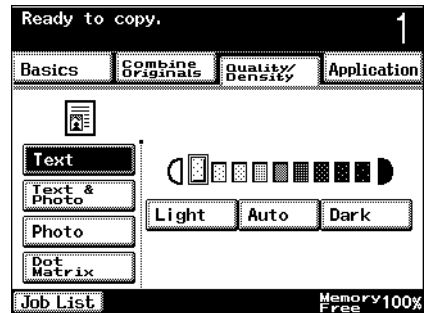

### 3.9 Selecting a Combine Originals setting

Multiple document pages (mainly 2, 4 or 8 pages) can be combined and printed on a single page, reducing paper use.

**Note**

*The factory default settings are the recommended zoom ratios.*

**Detail**

*When a combined copy setting is selected, the recommended zoom ratio is selected, and the document image is copied at a reduced size.*

*The recommended zoom ratios for each setting are listed below.*

*2-in-1:  $\times 0.707$*

*4-in-1:  $\times 0.500$*

*The machine can be set so that the recommended zoom ratios are not recalled. For details, refer to "Zoom Ratio for Combine/Booklets" on page 11-12.*

*When the "4 in 1" setting is selected, the page order (vertically or horizontally) can be selected. For details, refer to "4in1 Copy Order" on page 11-14.*

The following combined copies can be produced, depending on the Original and Copy ("Single-Sided" and "Double-Sided") settings selected in the Simplex/Duplex screen.

**Note**

*Combined copying is also possible with multiples of document pages (3, 5, 6 or 7 pages) not shown in the illustrations.*

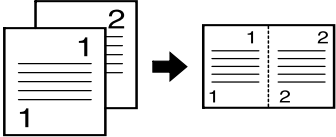
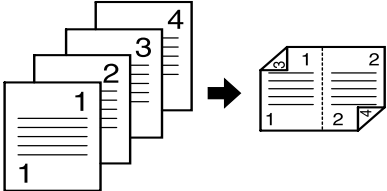
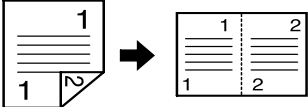
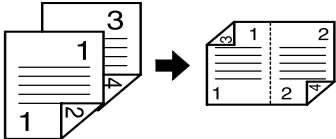
Setting	Original/copy settings and description
<p>2 in 1 (page 3-46)</p>	<p>Single-Sided → Single-Sided Two single-sided documents is copied onto one double-sided sheet.</p> 
	<p>Single-Sided → Double-Sided Four single-sided documents are copied onto one double-sided sheet.</p> 
	<p>Double-Sided → Single-Sided One double-sided document is copied onto one single-sided sheet.</p> 
	<p>Double-Sided → Double-Sided Two double-sided documents are copied onto one double-sided sheet.</p> 

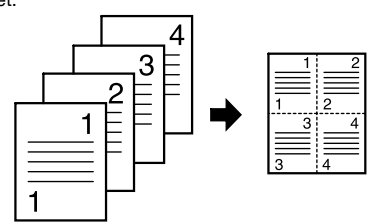
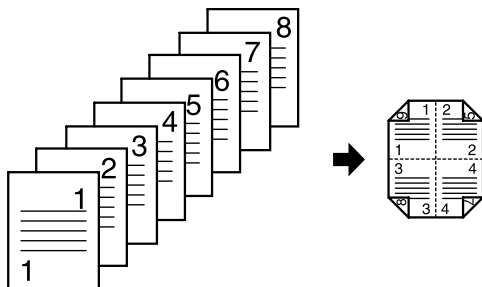
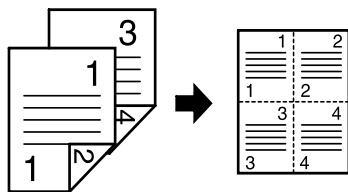
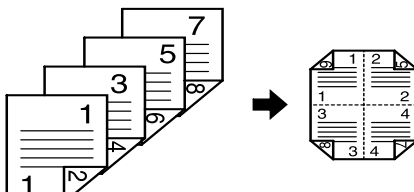
Setting	Original/copy settings and description
<p>4 in 1 (page 3-46)</p>	<p>Single-Sided → Single-Sided Four single-sided documents are copied onto one single-sided sheet.</p> 
	<p>Single-Sided → Double-Sided Eight single-sided documents are copied onto one double-sided sheet.</p> 
	<p>Double-Sided → Single-Sided Two double-sided documents are copied onto one single-sided sheet.</p> 
	<p>Double-Sided → Double-Sided Four double-sided documents are copied onto one double-sided sheet.</p> 

### Copying multiple document pages onto a single page (combined copy settings)

- 1 In the Simplex/Duplex screen, select the appropriate settings under “Orig.” and “Copy” for the desired combined copy. (For details, refer to page 3-39.)

- 2 In the Basics screen, touch [Combine Originals].

The Combine Originals screen appears.

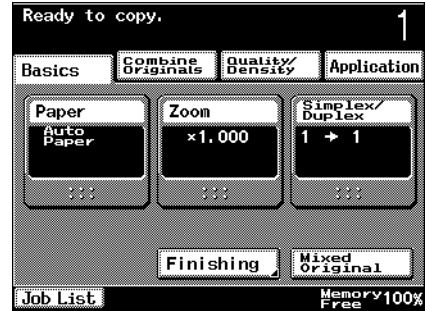

- 3 Select the desired combined copy settings.

- To cancel the setting, touch the button again to deselect it.

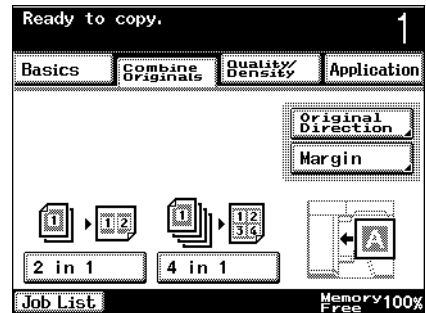



## 3.10 Selecting finishing for copies

Various settings are available for sorting and finishing copies that are fed out.





### Note

*The factory default setting is “Non-Sort”.*



### Detail

*If no finisher is installed and the following conditions are met, printed copies can be fed out and sorted/grouped in an alternating crisscross pattern (crisscross sorting and crisscross grouping).*

- Letter or 5-1/2 × 8-1/2 paper is used.
- Paper of the same size and type is loaded with the  orientation in one paper tray and with the  orientation in another tray.
- The “Auto Paper Select” setting is selected.
- The “Mixed Original” setting is not selected.
- The “Cover Mode” and “Insert Sheet” functions are not set.
- The “Image Repeat” function is not set.

*Select the “Booklet” function in the Book Copy/Repeat screen of the Application screen when center binding (“Crease” and “2 Staples” settings) is set.*

The following six finishing settings are available.

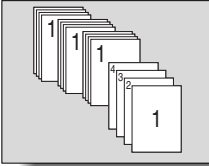
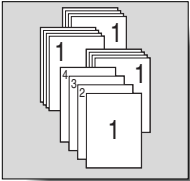
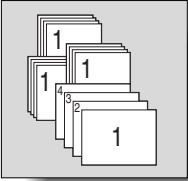
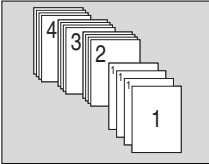
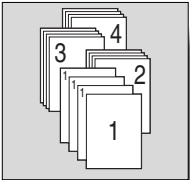
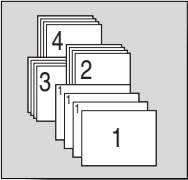
Setting	Description	
Non-Sort	Select this setting to copy without using a Finishing setting.	
Sort	Select this setting to separate each set of a multi-page document. 	
	Shift Sorting Each set of copies is fed out shifted to separate them. 	Crisscross Sorting Each set of copies is fed out in an alternating crisscross pattern to separate them. 
	Group	Select this setting to separate the copies of each page in a multi-page document. 
Shift Grouping The copies of each page are fed out shifted to separate them. 		Crisscross Grouping The copies of each page are fed out in an alternating crisscross pattern to separate them. 

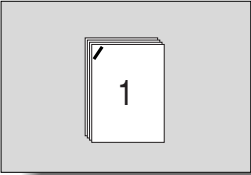
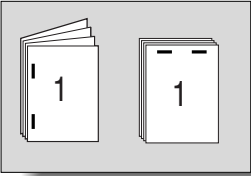
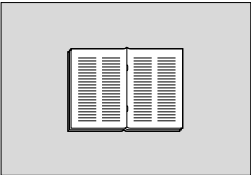
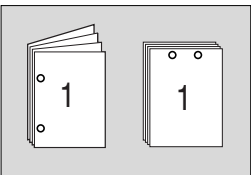
Setting	Description
Corner Staple	<p>Select this setting to bind the copies with a staple in the upper-left corner.</p> 
2 Staples	<p>Select this setting to bind the copies with two staples.</p> 
Center Binding ("Crease" and "2 Staples" settings)	<p>The copies are folded in half, then stapled at two places along the center.</p> 
Hole Punch	<p>Holes are punched in the copies for filing them.</p> 



## Required options for the finishing settings

Setting	Required options
Non-Sort	-
Sort	-
Shift sorting	Finisher
Crisscross sorting	-*
Group	-
Shift grouping	Finisher
Crisscross grouping	-*
Corner Staple	Finisher
2 Staples	Finisher
Center binding ("Crease" and "2 Staples" settings)	Finisher and saddle stitcher
Hole-Punch	Finisher and punch unit

\* Crisscross sorting and crisscross grouping are not available if a finisher is installed.

The following procedures describe how to select Finishing settings.

**Separating copies by sets ("Sort" setting)**

- ✓ The factory default setting is "Non-Sort".
- ✓ If "Sort" is selected while no finisher is installed, printed copies will be fed out and sorted in an alternating crisscross pattern if the following conditions are met.
  - Letter or 5-1/2 × 8-1/2 paper is used.
  - Paper of the same size and type is loaded with the  orientation in one paper tray and with the  orientation in another tray.
  - The "Auto Paper Select" setting is selected.
  - The "Mixed Original" setting is not selected.
  - The "Cover Mode" and "Insert Sheet" functions are not set.
  - The "Image Repeat" function is not set.

If "Sort" is selected and the finisher is installed, copies are fed out shifted to separate them.

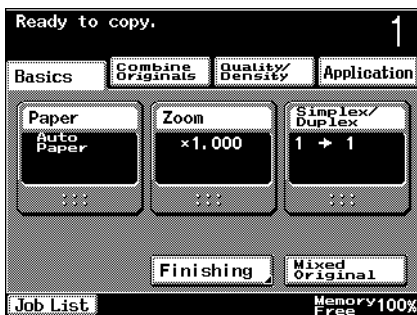

- 1 In the Basics screen, touch [Finishing].  
The Finishing screen appears.

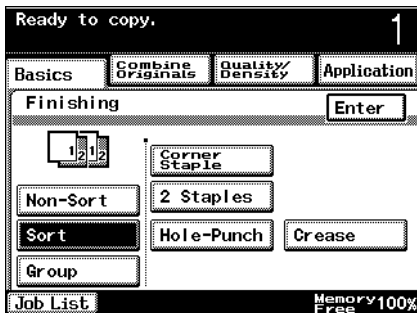

- 2 Touch [Sort].



### Separating copies by pages (“Group” setting)

- ✓ The factory default setting is “Non-Sort”.
- ✓ If “Group” is selected while no finisher is installed, printed copies will be fed out and grouped in an alternating crisscross pattern if the following conditions are met.
  - Letter or 5-1/2 × 8-1/2 paper is used.
  - Paper of the same size and type is loaded with the  orientation in one paper tray and with the  orientation in another tray.
  - The “Auto Paper Select” setting is selected.
  - The “Mixed Original” setting is not selected.

If “Group” is selected and the finisher is installed, copies are fed out shifted to separate them.

- 1 In the Basics screen, touch [Finishing].  
The Finishing screen appears.



- 2 Touch [Group].

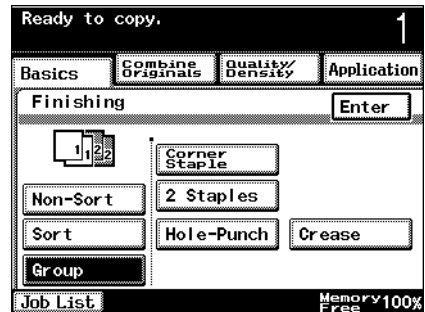

### Stapling copies (staple settings)



#### Detail



*In order for copies to be stapled, all of the following conditions must be met.*

- *The paper width must be between 7-1/4 inch and 11-3/4 inch*
- *The paper length must be between 5-1/2 inch and 17 inch*
- *If the "Mixed Original" setting is selected, all copies must be printed with paper of the same width.*

*If a staple setting is to be selected, select the orientation in which the document is positioned. If an Original Direction setting is not selected, the copies may not be stapled as desired.*

*For details on specifying the document orientation, refer to "Selecting the document orientation (Original Direction settings)" on page 3-19.*

When finisher is installed

Paper Weight	Paper Size	Loading Capacity (detected in either measurement)	
15 lb to 24 lb	Letter 	1,000 sheets	6 inch
	11 x 17  , Legal 	500 sheets	3 inch

### To bind copies with staples

- 1 In the Basics screen, touch [Finishing].  
The Finishing screen appears.



- 2 Touch either [Corner Staple] or [2 Staples].
  - If "Corner Staple" is selected, the copies are bound together with a staple in the upper-left corner.
  - If "2 Staples" is selected, [Position Setting] appears in the screen. To select the binding position, continue with step 3.
  - If a staple setting is selected, the [Sort] setting is automatically selected.
  - To cancel the staple setting, touch [Corner Staple] or [2 Staples] again to deselect it.



- 3 Touch [Position Setting], and then select the desired position.
  - Touch [Auto] to automatically determine the binding position according to the orientation of the loaded document.

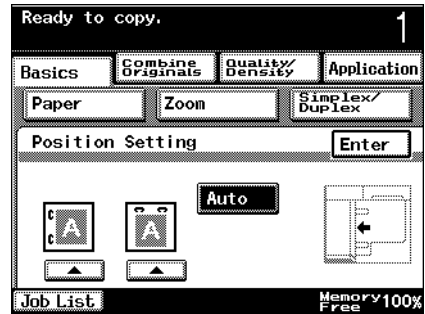

- 4 Touch [Enter].

The Finishing screen appears again.

### Punching holes in copies (punch settings)



#### Detail

*If a punch setting is to be selected, select the orientation in which the document is positioned. If an Original Direction setting is not selected, holes may not be punched in the copies as desired. For details on specifying the document orientation, refer to “Selecting the document orientation (Original Direction settings)” on page 3-19.*

When finisher is installed

Paper Weight	Paper Size
16 lb to 24 lb	11 × 17  , Letter

### To punch holes in copies

- 1 In the Basics screen, touch [Finishing].  
The Finishing screen appears.





## 2 Touch [Hole-Punch].

- To cancel the punch setting, touch [Hole-Punch] again to deselect it.

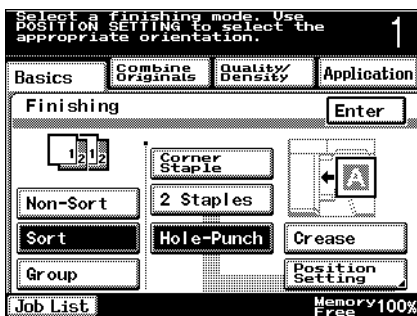

## 3 Touch [Position Setting], and then select the desired position.

- Touch [Auto] to automatically determine the position of the punched holes according to the orientation of the loaded document.

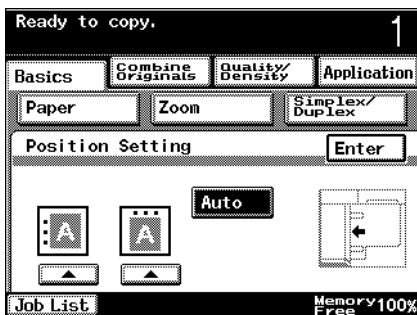



## 4 Touch [Enter].

The Finishing screen appears again.

### Binding copies at the center

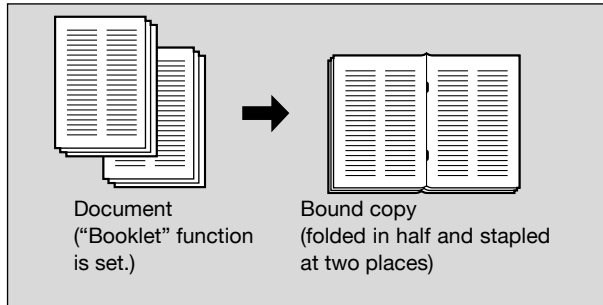
Copies can be fed out folded in half and stapled at two places along the center.



Paper Weight	Paper Size	Number of Bound Pages
15 lb to 24 lb	Letter  , 11 × 17 	2 to 15 sheets

### To bind copies at the center

- ✓ For details on specifying the “Booklet” function, refer to “Creating booklet copies (“Booklet” function)” on page 8-22.
- ✓ The position of the fold and the center staples can be adjusted from the Utility mode. For details, refer to “Crease/Center Staple” on page 11-17.

- 1 Select the “Booklet” function in the Book Copy/Repeat screen of the Application screen.
- 2 In the Basics screen, touch [Finishing].



- 3 The Finishing screen appears.  
Touch [2 Staples] and [Crease].

- To cancel center binding, touch [2 Staples] and [Crease] again to deselect them.

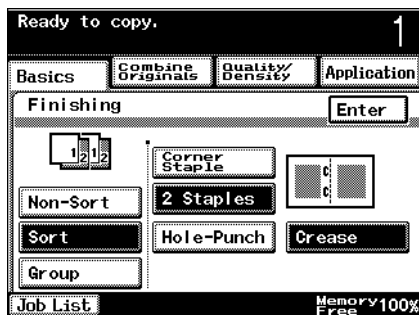

- 4 Touch [Enter].  
The Basics screen appears again.

### 3.11 Scanning the next document during printing (reserving a copy job)

The settings for the next copy job can be specified and the document can be scanned while a copy operation is being performed so that it can be printed once the current copy operation is finished.

#### To reserve a copy job

- ✓ A copy job can be reserved only if optional hard disk is installed.
  - ✓ Up to 5 copy jobs, including the current copy job, can be queued.
  - ✓ A copy job can be reserved after scanning of the loaded document is finished.
  - ✓ A copy job cannot be reserved while a document is being scanned.
  - ✓ For details on positioning the document, refer to “Feeding the document” on page 3-8.
  - ✓ To stop the job being printed, press the [Stop] key. For details, refer to “Stopping/deleting a job” on page 3-63.
- In addition, the job can be deleted from the Job List screen. For details, refer to “To delete a job” on page 4-25.

- 1 Press the [Start] key to begin scanning and printing the current copy job.

A message appears, indicating that the document is being scanned.

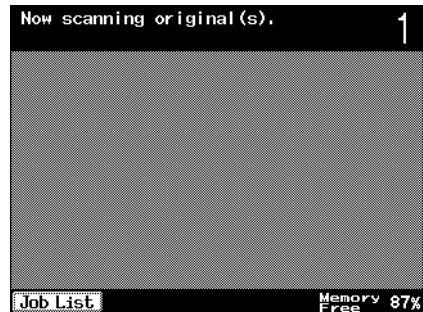

- 2 When the message “Ready to accept another job.” appears, copy settings can be specified for the next copy job.



- 3 Press the [Start] key.
- 4 After the current copy job is finished, the next copy job begins.

## 3.12 Stopping/deleting a job

The following procedure describes how to stop scanning the document, stop the printing operation and delete the copy job.

### To stop/delete a copy job

- ✓ If a document is being scanned for a job, pressing the [Stop] key stops scanning and printing.

- 1 Press the [Stop] key while a document is being scanned or a job is being printed.

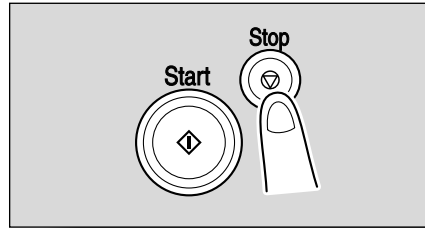

After the message “Copy cycle temporarily suspended.” appears, scanning and printing stops. The Stop screen appears.



- 2 Perform the desired operation.
  - To delete a stopped or queued job, touch the button for the job to be deleted. The job is deleted.
  - To continue the stopped job, press the [Start] key.



#### Detail

*A job can also be deleted from the Job List screens. For details, refer to “To delete a job” on page 4-25.*

*A function other than a copy function cannot be selected while pages are being scanned for copying, while copy scanning is paused, or while printing is paused.*



---



## **Additional copy operations**



## 4 Additional copy operations

### 4.1 Checking the copy settings (Mode Check)

From the Check Job Details screens, the current copy settings can be checked and changed if desired.

#### To check the settings

- 1 Press the [Mode Check] key.

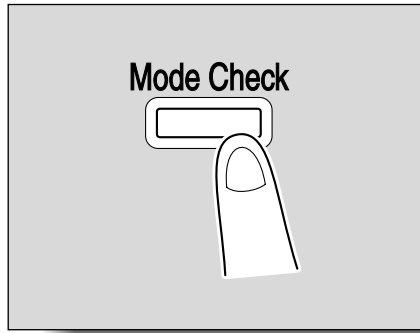

The Check Job Details screen appears.

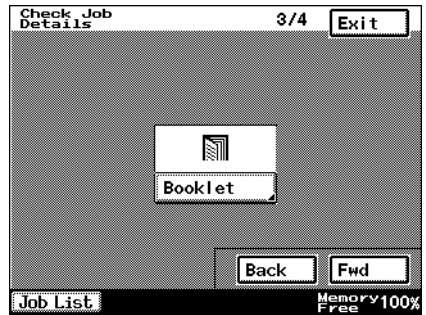
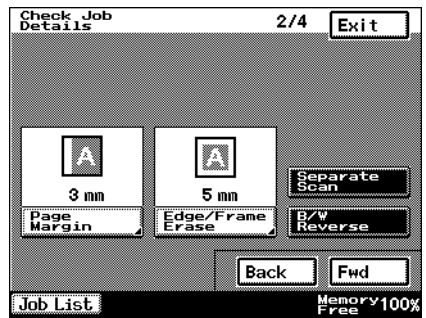
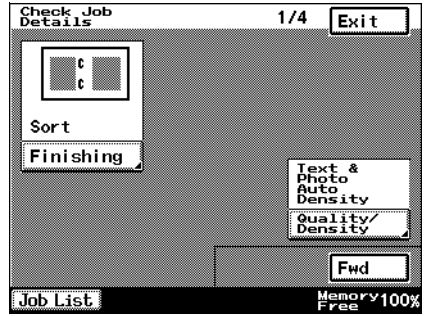

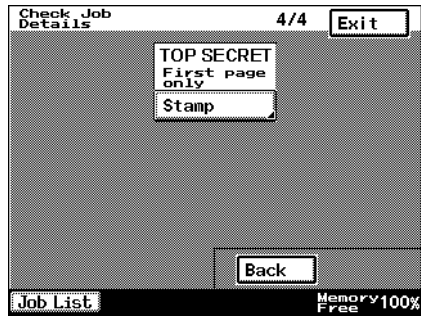

- 2 After checking the settings, touch [Exit] or press the [Mode Check] key again.

The Basics screen appears again.



#### Detail

*There are four Check Job Details screens. The number of the currently displayed screen appears to the right of the screen title.*

*To display the previous screen, touch [Back]. To display the next screen, touch [Fwd].*

*If the setting for a function has been changed from the default, the button for that function appears selected.*

#### To change the settings

- 1 Press the [Mode Check] key.
- 2 Touch [Back] or [Fwd] until the button for the function to be changed is displayed.
- 3 Touch the button for the function whose setting is to be changed.  
The screen for specifying the setting appears.
- 4 Follow the appropriate procedure to change the setting.

## 4.2 Printing a sample to check the settings (Proof Copy)

Before printing a large number of copies, a single proof copy can be printed to be checked. This prevents copy errors from occurring.

### To make test prints

- 1 Position the document to be copied. (Refer to page 3-8 for details.)
  - The “Proof Copy” function can be used only if the machine has been set for 2 or more copies.

- 2 Select the desired copy settings.

- 3 Press the [Proof Copy] key.

A single proof copy is printed.

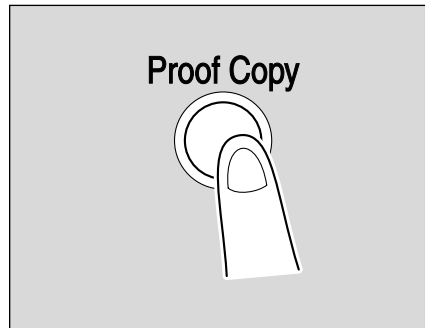

- 4 Check the proof copy.
  - If the proof copy was printed as desired, skip to step 8.
  - To change the copy settings, continue with step 5.

- 5 Touch [Change Setting] in the screen that appeared when the proof copy was printed.

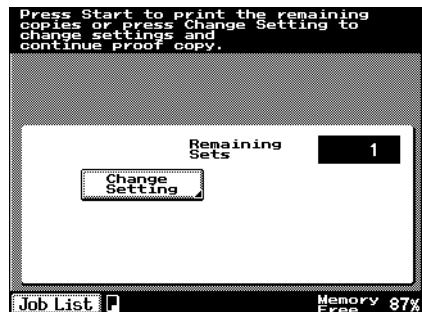

6 In the Proof copy screen, change the copy settings as desired.

- The Finishing settings appear in the Proof copy screen only if they have been specified for the job being proofed. If the copy settings cannot be changed, stop printing the proof copy. Next, press the [Reset] key to cancel the copy settings, and then specify the desired settings.

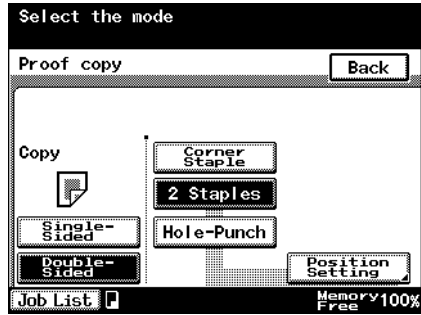

7 Press the [Proof Copy] key to print another proof copy.

- If copying stops while the Proof copy screen is displayed or while changing settings after the proof copy was printed, press the [Reset] key. A screen for stopping the job appears. Select the job to be deleted to delete the job.
- To stop the proof copy while scanning or printing, perform the operation described in “Stopping/deleting a job” on page 3-63.

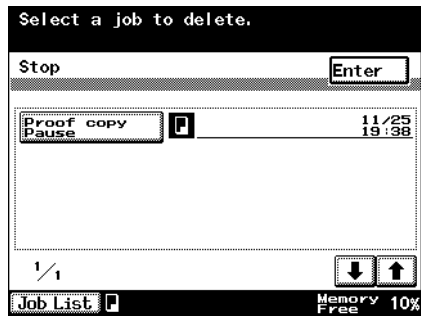

8 Press the [Start] key.

The specified copy settings are queued as a job.



#### Note

*The number of copies printed for the proof copy is included in the number of copies that are specified. If the setting was changed, use the keypad to enter the number copies.*

### 4.3 Interrupting a copy job (Interrupt mode)

The current jobs can be temporarily interrupted so a document can be copied with different copy settings.

#### To interrupt a copy job

1 Position the document to be copied. (Refer to page 3-8 for details.)

2 Press the [Interrupt] key.

- If a job is being printed, the message “Job is stopping.” appears.

The indicator on the [Interrupt] key lights up in green and printing of the current job stops.

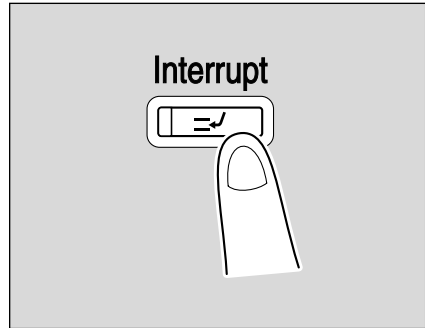

? What happens if the [Interrupt] key is pressed while a document is being scanned?

→ Pressing the [Interrupt] key returns all copy settings, except the number of copies, to their defaults.

3 Select the desired copy settings.

4 Press the [Start] key.

Printing begins for the job that the previous job was interrupted for.

5 After the interrupting job has finished printing, press the [Interrupt] key.

The indicator on the [Interrupt] key goes off.

The copy settings return to those specified before printing was interrupted.



#### Note

*If the interrupting job is cancelled, printing for the interrupted job automatically restarts.*

## 4.4 Registering copy programs (Mode Memory)

Up to 10 copy programs can be registered.

The registered copy programs can be recalled and used for copying.

### To register a copy program

- 1 Using the touch panel and control panel keys, specify the copy settings to be registered in the copy program.

? Can the current settings be checked?

→ To check the currently specified copy settings, press the [Mode Check] key.

- 2 Press the [Mode Memory] key.

The Program screen appears.

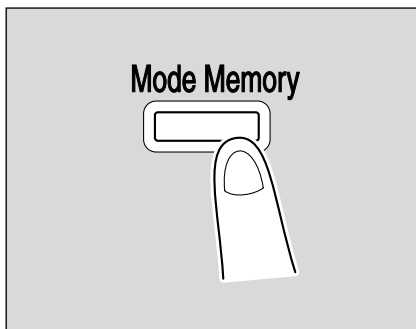

- 3 Touch [Set].



- 4 Touch the button for the program number where a program is to be registered.
- If a program has not yet been registered with the program number button that is pressed, the empty icon disappears from the number button to indicate that a program is registered with it.

No program registered



Program registered



- If a program has already been registered with the program number button that is pressed, a message appears, requesting confirmation to overwrite the program. To overwrite the program, touch [Yes], and then touch [Enter]. To cancel the registration, touch [No], and then touch [Enter].

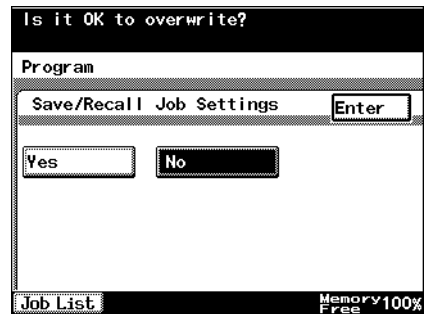

- ? What if programs have already been registered to all of the program numbers?
- If there are no program numbers where no program has been registered yet, the program registered at a program number will be overwritten. To check the copy program settings before overwriting it, refer to “Checking the copy settings (Mode Check)” on page 4-2.



#### Detail

To stop registering the program, press the [Reset] key or the [Mode Memory] key. No matter which screen is displayed, the registration is cancelled.



## To recall a copy program

The registered copy programs can be recalled and used for copying.

- 1 Position the document to be copied. (Refer to page 3-8 for details.)
- 2 Press the [Mode Memory] key.  
The Program screen appears.

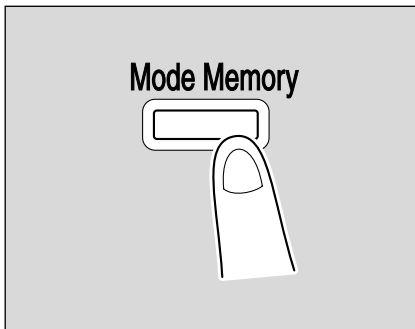

- 3 Touch [Recall].

- To stop recalling a copy program, press the [Reset] key or the [Mode Memory] key.

? Can the specified settings for a copy program be checked?

- To check the program copy settings

before recalling the copy program, refer to "Checking the copy settings (Mode Check)" on page 4-2.



- 4 Touch the button for the program number registered with the desired copy settings.  
The program copy settings are recalled, and the Basics screen appears again.
  - If [Enter] is touched without touching a program number button, the Basics screen appears again and no copy program is recalled.
- 5 Press the [Start] key.  
Copying begins with the recalled copy settings.

## To checking the copy settings

The copy settings to be registered as a copy program can be checked.

- 1 Press the [Mode Memory] key.

The Program screen appears.

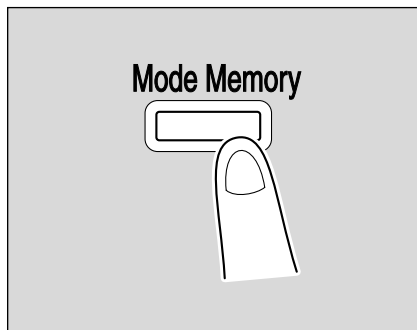

- 2 Touch [Check].



- 3 Touch the program number button registered with the copy settings to be checked.

The Check Program screen appears.

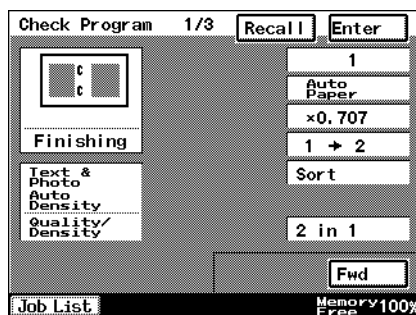

- 4 Check the copy settings registered with the selected program number.
  - The program whose copy settings are being checked in the Check Program screen can be recalled. Touch [Recall] to recall the registered copy settings and display the Basics screen again.
- 5 Touch [Enter].  
The Program screen appears again.



#### Detail

*There are three Check Program screens. Touch [Fwd] to display the next screen, or touch [Back] to display the previous screen.*

*The copy settings cannot be changed from the Program Check screens.*

#### To delete a registered copy program

Registered copy programs can be deleted.

- 1 Press the [Mode Memory] key.  
The Program screen appears.

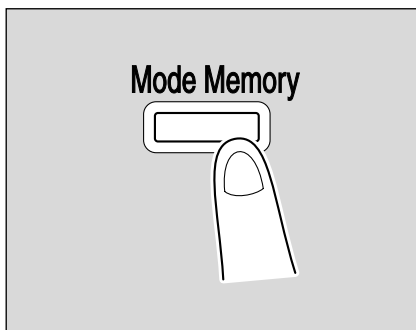

- 2 Touch [Delete].



- 3 Touch the program number button registered with the copy settings to be deleted.

A message appears, requesting confirmation to delete the copy program.



- 4 Touch [Yes], and then touch [Enter]. To stop deleting the copy program, touch [No], and then touch [Enter].

The Program screen appears again.

## 4.5 Specifying control panel settings (Accessibility mode)

This section contains details on the procedures for specifying control panel settings and adjusting the touch panel.

### To display the Accessibility Settings screen

- 1 Press the [Accessibility] key.

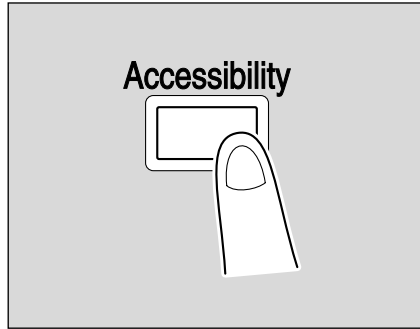

The Accessibility Settings screen appears.

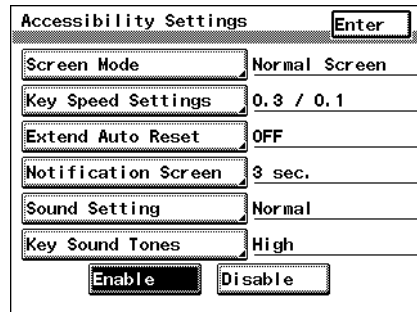

- 2 Touch the button for the Accessibility function whose setting is to be changed.

The screen for the selected function appears.



### Detail

To return to the Basics screen from the Accessibility Settings screen, press the [Accessibility] key or the [Reset] key, or touch [Enter], [Set] or [Reset].

If [Reset] in the Accessibility Settings screen is touched to return to the Basics screen, the settings specified in the Accessibility Settings screen are not applied, and the Basics screen is reset to its factory default settings.

If [Set] or [Enter] in the Accessibility Settings screen is touched to return to the Basics screen, the Basics screen is displayed with the settings specified in the Accessibility Settings screen applied.

### To set the “Screen Mode” function

Select whether the screens appear in the touch panel in black on white or in white on black.

✓ The factory default setting is “Normal Screen”.

1 Display the Accessibility Settings screen. (For details, refer to page 4-14.)

2 Touch [Screen Mode].

The Screen Mode screen appears.

3 Select the setting for the desired touch panel display.

- Touch [Inverted Screen] to specify that the screens appear in the touch panel in white on black.
- Touch [Normal Screen] to return the touch panel to its original display.

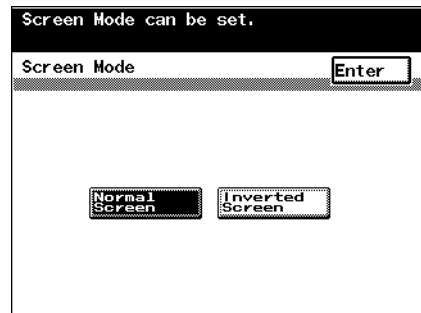

4 Touch [Enter].

The Accessibility Settings screen appears again.

### To set the “Key Speed Settings” function



It is possible to specify the length of time until the value begins to change after a touch panel button is held down and the length of time for the value to change to the next number.



- ✓ The factory default setting for “Time to Start” is 0.3 second, and the factory default setting for “Interval” is 0.1 second.

1 Display the Accessibility Settings screen. (For details, refer to page 4-14.)

2 Touch [Key Speed Settings].

The Key Speed Settings screen appears.

3 Touch  and  to specify the starting time and the interval for the key repeat feature.

The starting time and the interval for the key repeat feature specify the speed at which a value changes when  or  is held down to change a setting.

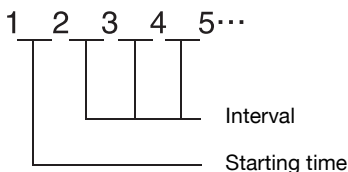
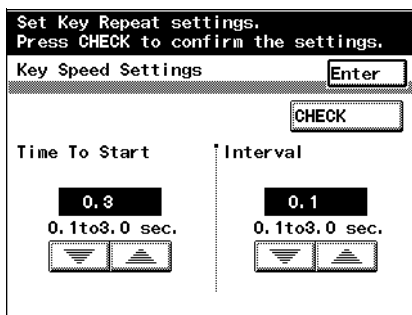

- ? How are the specified time settings checked?
- Touch [CHECK] to check the specified key repeat settings.

4 Touch [Enter].

The Accessibility Settings screen appears again.

### To set the “Extend Auto Reset” function

If no operation is performed for a specified length of time, an automatic panel reset operation is performed and all settings in the touch panel return to their default settings. It is possible to specify the length of time that a confirmation screen is displayed before the settings return to their defaults.

- ✓ For details on the automatic panel reset operation, refer to “Automatically returning to the default settings (Automatic panel reset)” on page 2-27.
- ✓ The factory default setting is “OFF”.

1 Display the Accessibility Settings screen. (For details, refer to page 4-14.)

2 Touch [Extend Auto Reset].

The Extend Auto Reset screen appears.

3 Select the setting for the desired length of time that the confirmation screen is displayed.

- Touch [30 sec.], [60 sec.], [90 sec.] or [120 sec.].
- To reset the settings to their defaults without displaying a confirmation screen, touch [OFF].

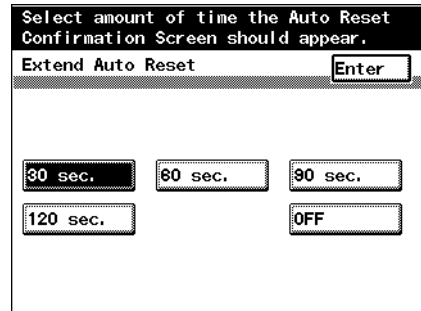

4 Touch [Enter].

The Accessibility Settings screen appears again.



#### Detail

*The operations where the machine enters Low Power mode or Sleep mode or where the touch panel is darkened are not affected by the time specified for the “Extend Auto Reset” function. When specifying a time for the “Extend Auto Reset” function, specify a time shorter than that for entering Low Power mode or Sleep mode or for darkening the touch panel.*



### To set the “Notification Screen” function

It is possible to specify the length of time that the screen is displayed to confirm the reception number or job ID after copying is finished.

✓ The factory default setting is “3 sec.”.

**1** Display the Accessibility Settings screen. (For details, refer to page 4-14.)

**2** Touch [Notification Screen].

The Notification Screen screen appears.

**3** Select the setting for the desired length of time that the notification screen is displayed.

- Touch [3 sec.], [10 sec.] or [60 sec.].
- To display the notification screen until [Enter] is touched, touch [No Limit].

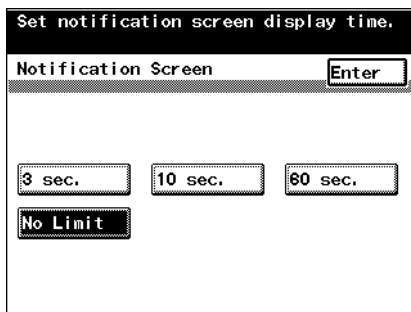

**4** Touch [Enter].

The Accessibility Settings screen appears again.

### To set the “Sound Setting” function

It is possible to specify the volumes of the tone that is sounded when a touch panel button is touched and of the alarm that is sounded when a malfunction occurs.

✓ The factory default setting is “Normal”.

1 Display the Accessibility Settings screen. (For details, refer to page 4-14.)

2 Touch [Sound Setting].

The Sound Setting screen appears.

3 Touch [Normal] or [Loud].

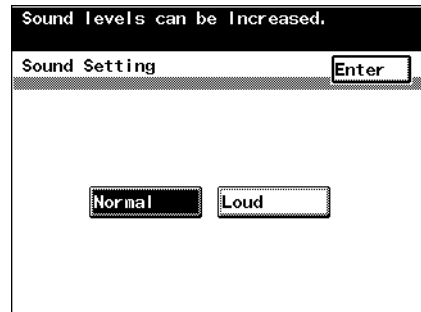

4 Touch [Enter].

The Accessibility Settings screen appears again.



#### Note

*The volume of the tone produced when a control panel key is pressed or when an alarm is sounded can also be changed from the Utility mode. For details, refer to “Tone volume parameters” on page 11-20.*

### To set the “Key Sound Tones” function

It is possible to specify the tone of the sound produced when a touch panel button is touched and of the alarm that is sounded when a malfunction occurs.

- ✓ The factory default setting is “High”.

**1** Display the Accessibility Settings screen. (For details, refer to page 4-14.)

**2** Touch [Key Sound Tones].  
The Key Sound Tones screen appears.

**3** Touch [Low], [Normal] or [High].

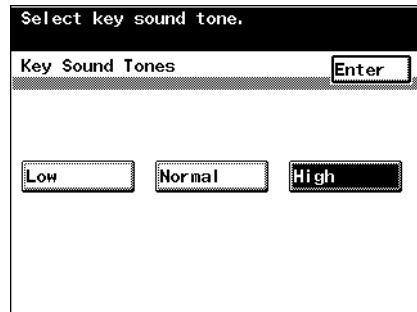

**4** Touch [Enter].  
The Accessibility Settings screen appears again.

## 4.6 Job List screens

### Jobs

Specifying the desired copy settings, then pressing the [Start] key queues the copy operation in this machine. This queued operation is called a job. In the same way, operations for making scans and computer printouts are also queued as jobs.

- Jobs that are being performed and jobs that are queued can be checked or deleted from the Job List screens.
- Jobs are printed starting with the one at the top of the Print Order list.

### Multi-job feature

While one job is being printed, another job can be queued. A maximum of 5 copy jobs can be queued.

When one job is finished being printed, the next queued print job automatically begins.

### Job List screens

Job	Print Order	Print	Type	Doc.
Copier Read Stopping				
Copier Printing				
Dialing			2nd Dest	
Sending			atesaki@std.	

1/2

Memory Free 70%

In the Job List screen, the following tabs for various specific functions can be displayed.

- Job: Lists the operations that are being performed
- Print Order: Lists the order of documents that are being copied or printed or waiting to be copied or printed
- Print: Lists the print status of documents being copied or printed
- Type: Used in Fax mode
- Doc.: Used in Fax mode and Box mode

**Detail**

*For details on the Com. tab of the Job List screen, refer to the User's Guide [Facsimile Operations].*

*For details on the Doc. tab of the Job List screen, refer to the User's Guide [Facsimile Operations] and the User's Guide [Box Operations].*



## 4.7 Performing operations on jobs

### To check a job being performed

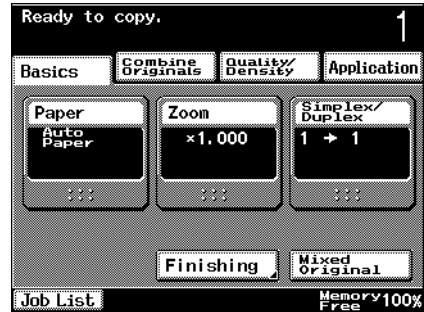
- 1 Touch [Job List].  
The Job List screen appears.



- 2 Check the job being performed.

- Touch  and  to display a different screen.
- A maximum of 8 jobs being performed can be displayed.

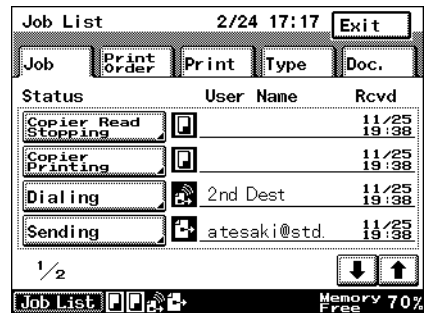

#### Detail

A job being performed or a job waiting to be performed, such as a queued job, can be deleted. For details, refer to "To delete a job" on page 4-25. In addition, the job can be deleted after the [Stop] key is pressed. For details, refer to "Stopping/deleting a job" on page 3-63.

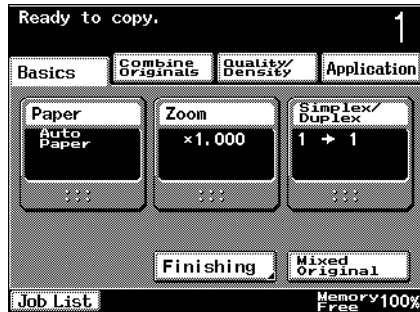

## To check the printing order

- 1 Touch [Job List].  
The Job List screen appears.

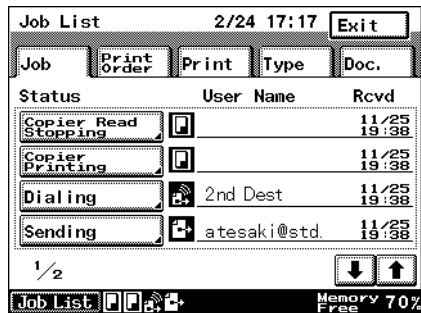

- 2 Touch [Print Order].



- 3 Check the printing order.
  - Touch  and  to display a different screen.
  - The printing order for a maximum of 8 jobs can be displayed.

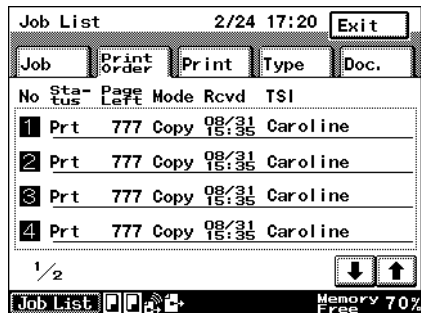

### Detail

A job being performed or a job waiting to be performed, such as a queued job, can be deleted. For details, refer to "To delete a job" on page 4-25. In addition, the job can be deleted after the [Stop] key is pressed. For details, refer to "Stopping/deleting a job" on page 3-63.



## To delete a job

A job being performed or a job waiting to be performed can be deleted.

- 1 Touch [Job List].

The Job List screen appears.



- 2 Select the job that you wish to delete.
  - If the job that you wish to delete is not displayed, touch  and  until the desired job is displayed.

The screen for deleting the selected job appears.

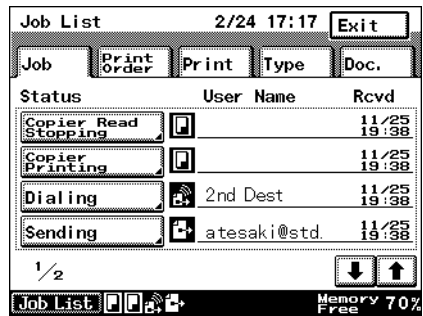

- 3 Check the information that is displayed, and then touch [Delete].

The selected job is deleted.

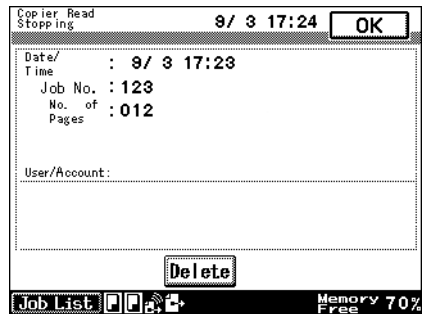

- 4 Touch [OK].

The Job List screen appears again.



**Detail**

*A job can also be deleted after the [Stop] key is pressed. For details, refer to "Stopping/deleting a job" on page 3-63.*

---



# Troubleshooting

## 5 Troubleshooting

### 5.1 When the message “Malfunction detected.” appears (Call technical representative)

If a malfunction that cannot be corrected by the user occurred, the message “Malfunction detected. Please call your Technical Representative.” appears. (call technical representative screen)

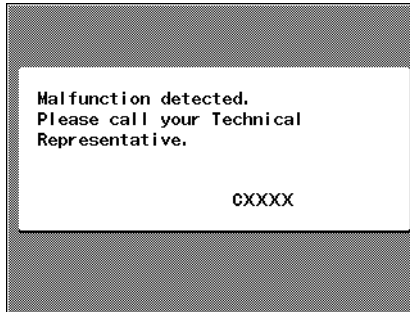

**To correct the error**

- 1 Write down the malfunction code (for example, C-0001) in the call technical representative screen.
- 2 Turn the machine off by using the [Power] (auxiliary power) key and the main power switch.

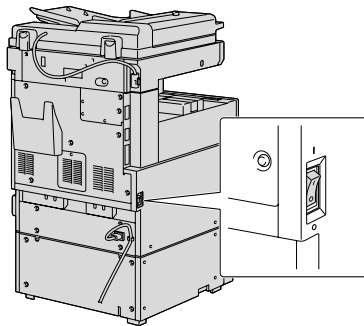
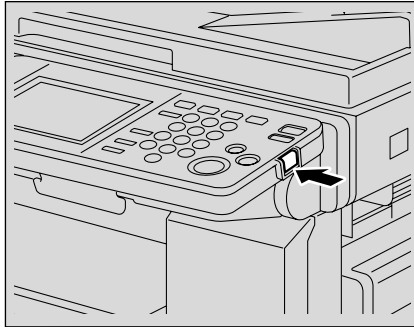

- 3 Unplug the machine.
- 4 Contact the technical representative, and inform them of the malfunction code.



**Reminder**

*Since the machine may be damaged, contact the technical representative according to the procedure described above as soon as the call technical representative screen appears.*

## 5.2 When the message “Misfeed detected.” appears

If a misfeed occurs during copying or printing, the message “Misfeed detected.” appears and the location of the misfeed is indicated in the screen. (misfeed screen)

At this time, copying and printing cannot continue until the misfeed is adequately cleared.

### Location of paper misfeed

“x” indicates the location of the paper misfeed. In addition, a lit “○” indicates areas where paper may have been misfed and that should be checked.

Example: Screen when a paper misfeed occurs in a paper tray



#### Note

*The procedure for clearing misfed paper differs depending on where the misfeed occurs. Determine the misfeed location by looking at the illustration displayed with the error message, and then clear the misfeed according to the appropriate procedure.*

**Paper misfeed indications**

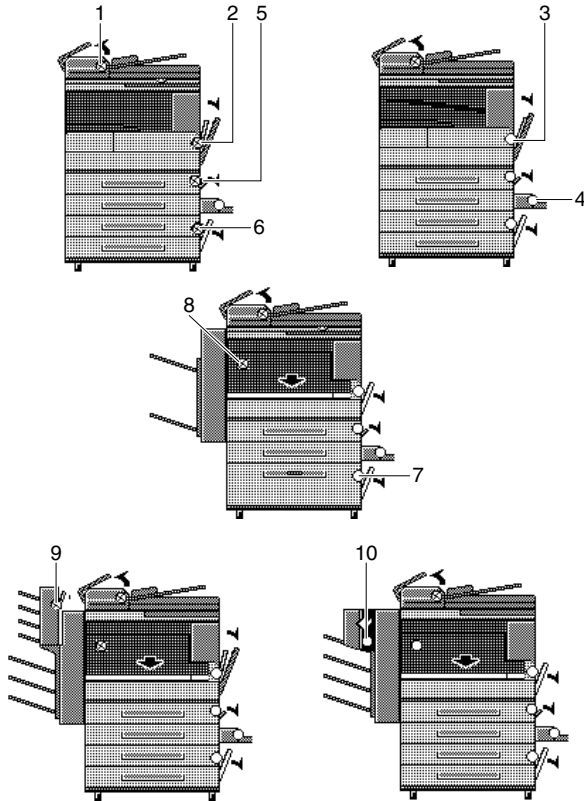

No.	Description
1	A paper misfeed in the ADF (page 5-6)
2	A paper misfeed in the automatic duplex unit (page 5-12) A paper misfeed in the 1st tray (page 5-15)
3	A paper misfeed in the fusing unit (page 5-8)
4	A paper misfeed in the bypass tray (page 5-13)
5	A paper misfeed in the 2nd tray (page 5-15)
6	A paper misfeed in the 3rd or 4th tray (page 5-17)
7	A paper misfeed in the LCT (page 5-18)
8	A paper misfeed in the finisher (page 5-19)
9	A paper misfeed in the mailbin kit (page 5-22)
10	A paper misfeed in the saddle stitcher (page 5-24)

**To clear a paper misfeed in the ADF**

- 1 Pull up the lever for the misfeed-clearing cover, and then open the cover.

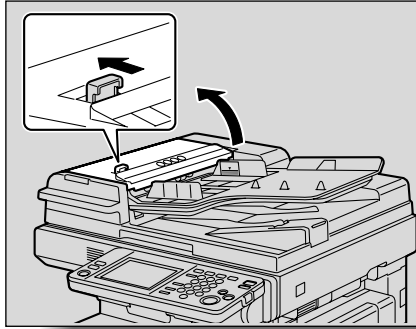

- 2 Carefully pull out any misfed paper.

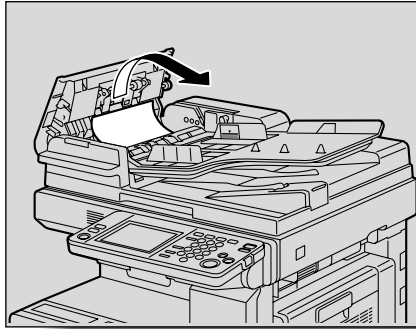

- 3 Swing up the document guide lever.

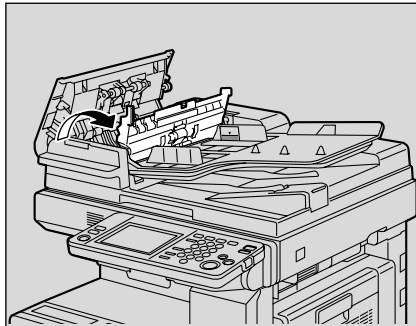

- 4 Turn the dial to feed out any misfed documents.

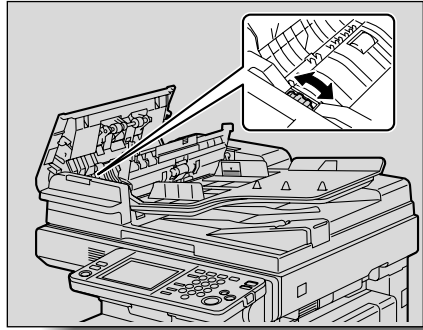

- 5 While supporting the document feed tray with your right hand, carefully pull out any misfed documents.

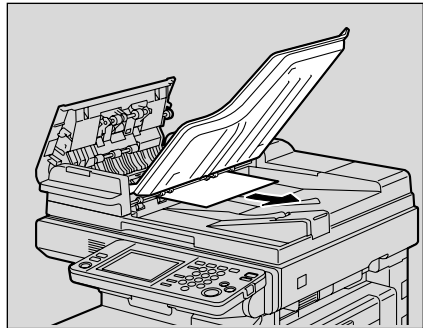

- 6 Return the document guide lever to its original position, and then close the misfeed-clearing cover.



**Detail**

*For details on the positions of paper misfeeds, refer to “Paper misfeed indications” on page 5-5.*



### To clear a paper misfeed in the fusing unit

- 1 Pull up the right-side door release lever, and then open the right-side door.

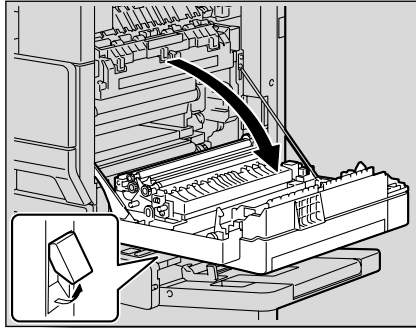

## CAUTION

The area around the fusing unit is **extremely hot**.



→Touching any part other than those indicated may result in burns. If you get burnt, immediately cool the skin under cold water, and then seek professional medical attention.

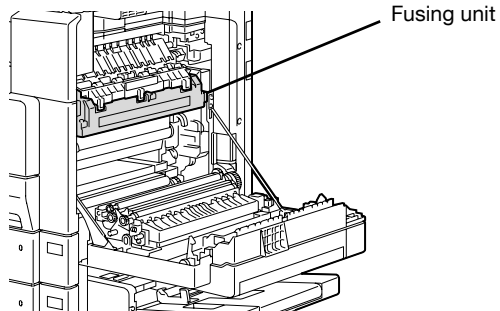

Fusing unit

- 2 Carefully pull out any misfed paper.

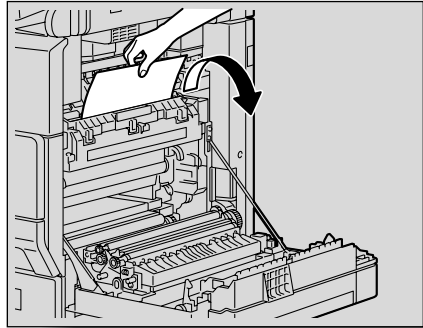

- Decreased copy quality may result if the surface of the image transfer roller is touched. Be careful not to touch the surface of the image transfer roller.

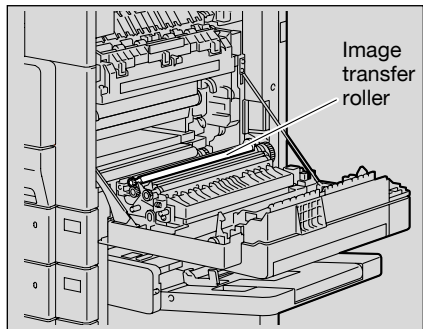

- 3 Open the fusing unit guide.

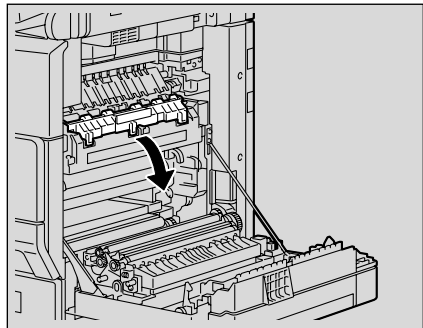

- 4 Carefully remove any misfed paper.

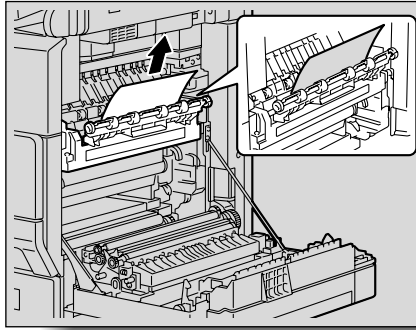

- 5 Open the switching guide, and then carefully pull out any misfed paper in the switchback unit.

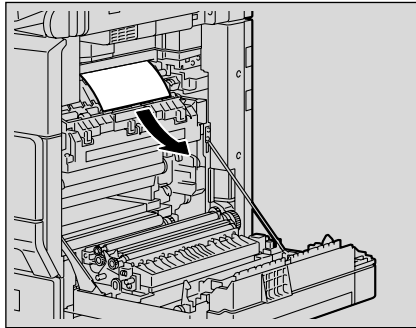

- 6 Carefully pull out any misfed paper in the fusing section.

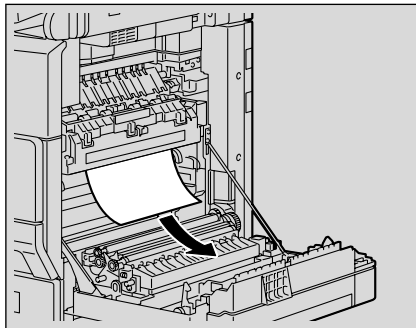

- 7 Carefully pull out any misfed paper around the image transfer roller.

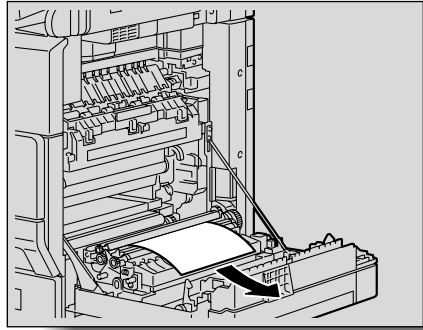

- 8 Carefully remove any misfed paper.

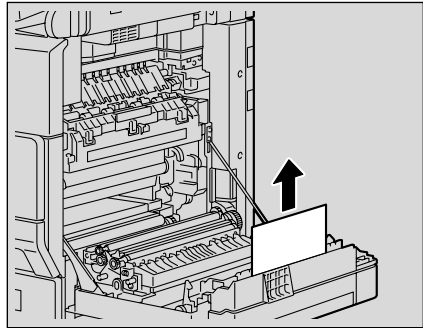

- 9 Close the right-side door.



**Detail**

*For details on the positions of paper misfeeds, refer to "Paper misfeed indications" on page 5-5.*

**Reminder**

*If the paper is misfed as described below, contact your technical representative.*

- *The paper is wrapped around the roller in the fusing unit.*
- *The paper is folded or shredded by the roller in the fusing unit.*
- *The paper that was removed tore and partly remains in the fusing unit.*

**To clear a paper misfeed in the automatic duplex unit**

- 1 Open the automatic duplex unit door.

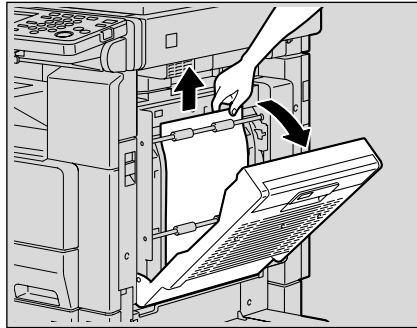

- 2 Carefully pull out any misfed paper.
- 3 Close the automatic duplex unit door.

**Detail**

*For details on the positions of paper misfeeds, refer to "Paper misfeed indications" on page 5-5.*

**To clear a paper misfeed in the bypass tray**

- 1 Remove all paper from the bypass tray.

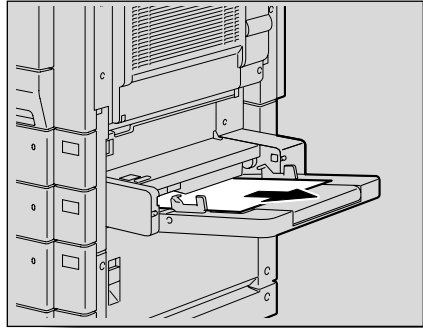

- 2 If misfed paper cannot be pulled out, pull the lever for the sliding plate of the bypass tray, and then pull the sliding plate toward you.

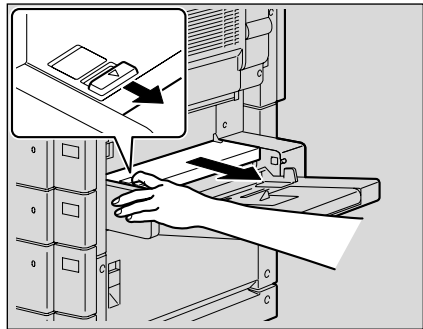

- 3 Press down on the sliding plate with your left hand and carefully pull out any misfed paper.

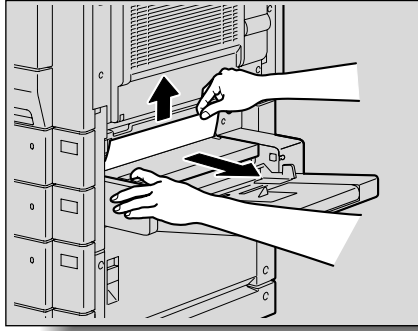

- 4 Return the bypass tray to its original position.

**Detail**

*For details on the positions of paper misfeeds, refer to “Paper misfeed indications” on page 5-5.*

**To clear a paper misfeed in the 1st or 2nd tray**

- 1** Open the bypass tray.

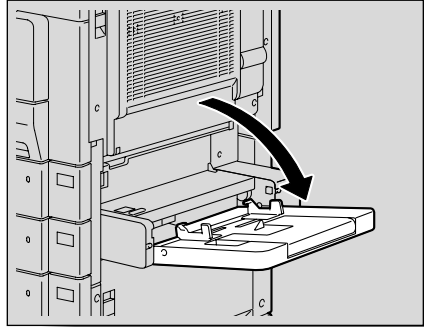

- 2** Pull up the lower right-side door release lever, and then open the lower right-side door of the paper feed unit indicated in the touch panel message.

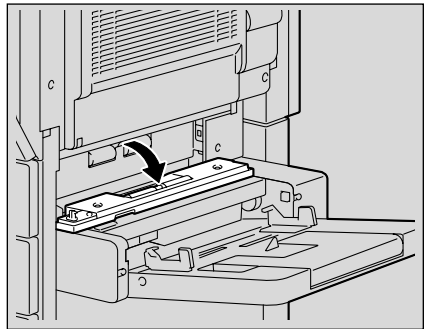



- 3 Carefully pull out any misfed paper.

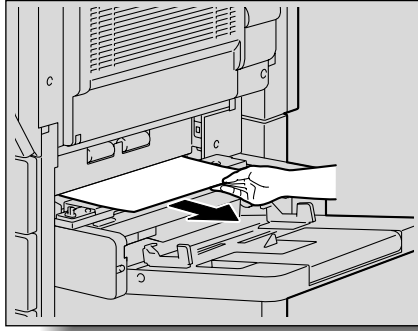

- 4 Close the lower right-side door.
- 5 Close the bypass tray.

**Detail**

*For details on the positions of paper misfeeds, refer to “Paper misfeed indications” on page 5-5.*

**To clear a paper misfeed in the 3rd or 4th tray**

- 1 Pull up the lower right-side door release lever, and then open the lower right-side door of the paper feed unit.

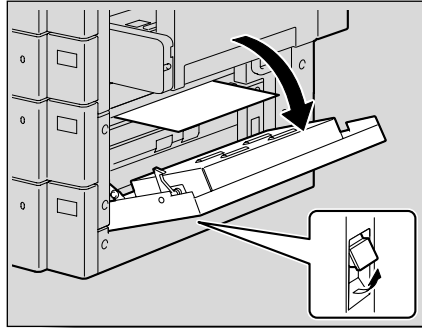

- 2 Carefully pull out any misfed paper.

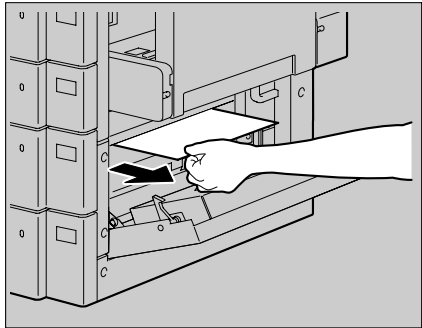

- 3 Close the lower right-side door.



**Detail**

*For details on the positions of paper misfeeds, refer to "Paper misfeed indications" on page 5-5.*

## To clear a paper misfeed in the LCT

- 1 Pull up the lower right-side door release lever, and then open the lower right-side door of the paper feed unit.

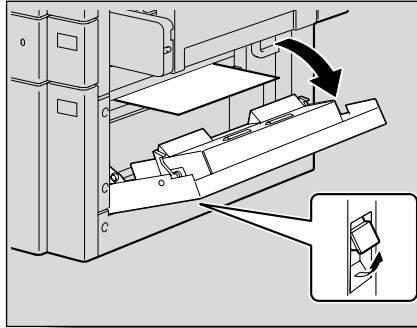

- 2 Carefully pull out any misfed paper.

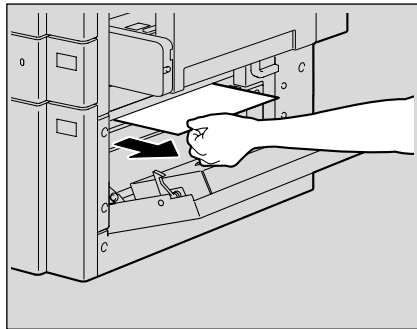

- 3 Close the lower right-side door.



### Detail

*For details on the positions of paper misfeeds, refer to "Paper misfeed indications" on page 5-5.*

**To clear a paper misfeed in the finisher**

- 1 Open the front door.

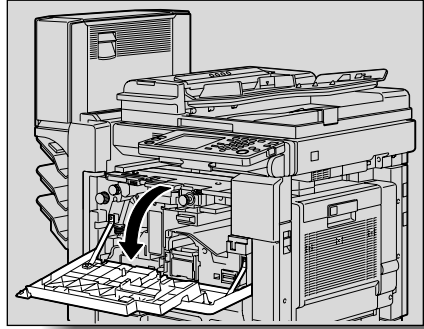

- 2 Lower lever FN1, and then pull out any misfed paper.

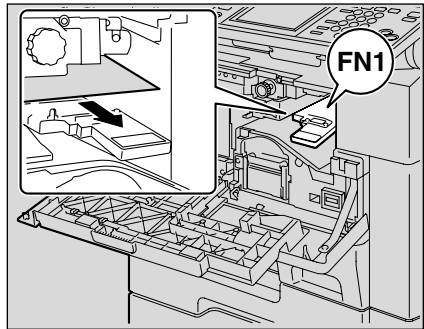

- 3 Turn dial FN2.

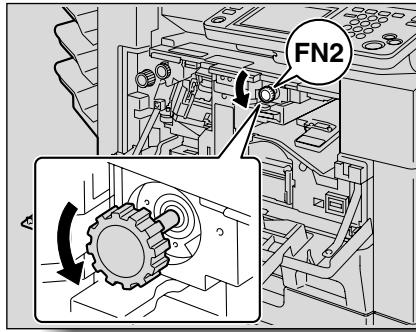

- 4 If the punch unit is installed, pull out the hole-punch waste container.

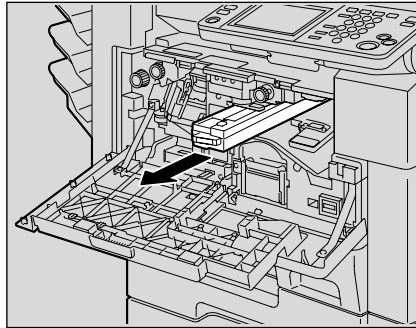

- 5 Lower lever FN3, and then pull out any misfed paper.

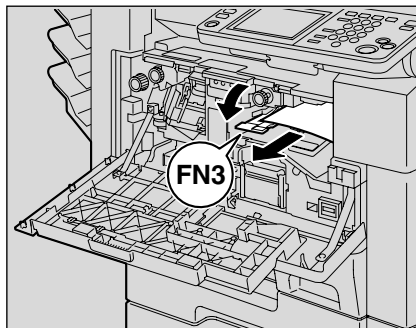

- 6 Return levers FN1 and FN3 to their original positions.
- 7 If the punch unit is installed, insert the hole-punch waste container into its original position.
- 8 Lower lever FN4.

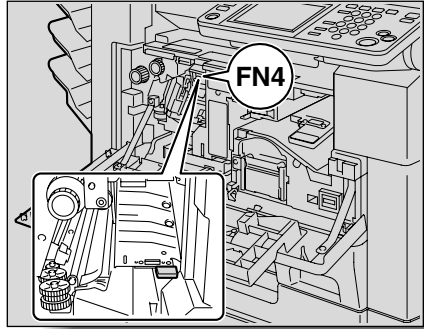

- 9 Turn dial FN5 or dial FN6, and then pull out any misfed paper.

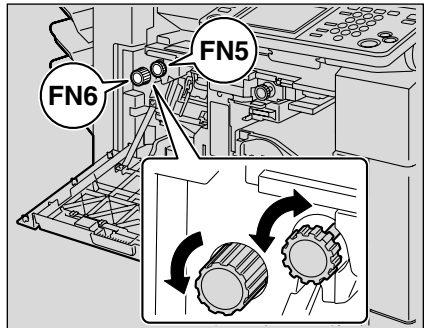

- 10 Return lever FN4 to its original position.
- 11 Close the front door.



**Detail**

*For details on the positions of paper misfeeds, refer to “Paper misfeed indications” on page 5-5.*

**To clear a paper misfeed in the mailbin kit**

- 1 Open the front door.

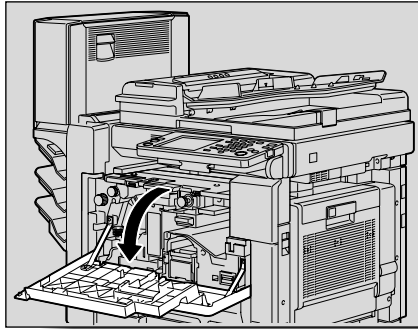

- 2 Turn dial FN5 or dial FN6 to feed out any misfed paper.

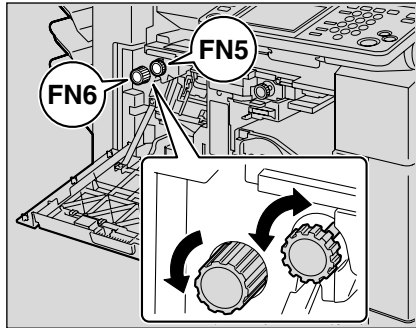

- 3 While pressing down lever FN7, pull out any misfed paper.

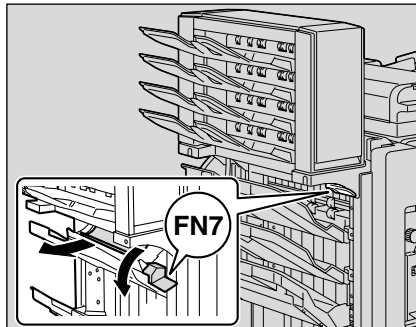

- 4 Pull handle FN8 to open the misfeed-clearing door.

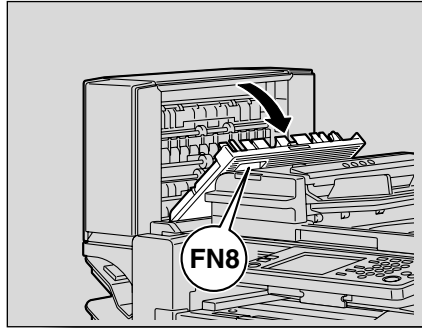

- 5 Pull out any misfed paper in the mailbin.

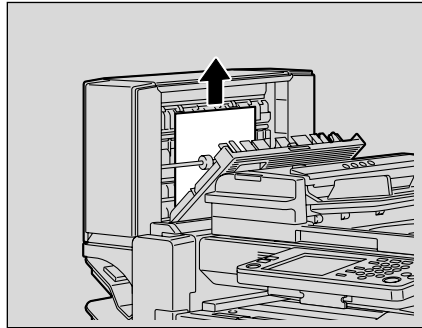

- 6 Close the misfeed-clearing door.

- 7 Close the front door.



**Detail**

*For details on the positions of paper misfeeds, refer to "Paper misfeed indications" on page 5-5.*



## To clear a paper misfeed in the saddle stitcher

- 1 Open the front door.

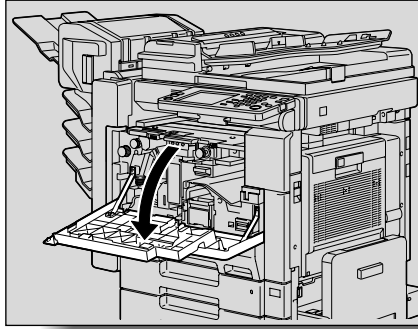

- 2 Turn dial FN5 or dial FN6 to feed out any misfed paper.

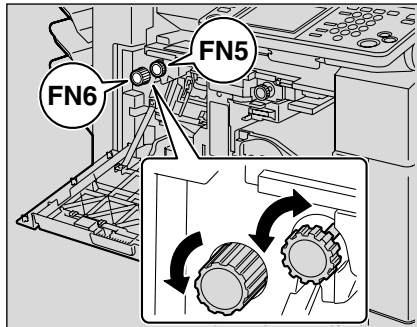

- 3 Remove all paper from the output tray.

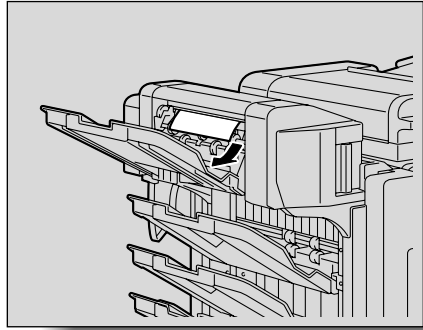

- 4 Open the misfeed-clearing door, and then pull out any misfed paper.

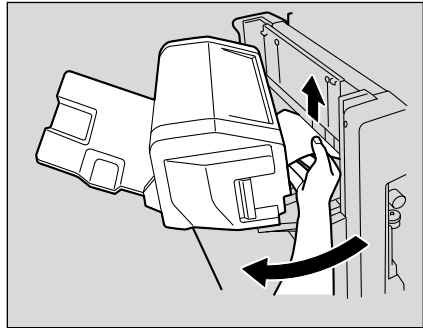

- 5 Close the misfeed-clearing door.

- 6 Close the front door.



**Detail**

*For details on the positions of paper misfeeds, refer to "Paper misfeed indications" on page 5-5.*

### 5.3 When the message “Replenish paper.” appears

If a tray has run out of paper while copying or after printing, the message “Replenish paper.” appears.

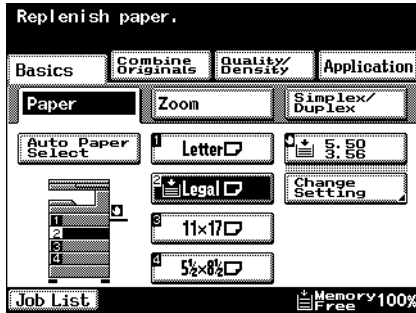

#### To replenish paper

- Check which paper tray appears highlighted in the touch panel, and then load it with paper.



#### Detail

*For details on loading paper into the paper trays, refer to “Loading paper into the 1st or 2nd tray” on page 2-54, “Loading paper into the LCT” on page 2-57, and “Loading paper into the bypass tray” on page 2-60.*

### 5.4 When the message “... Not enough remaining memory.” appears

This machine uses the memory to produce copies.

Since the amount of memory available is limited, the message “The job has been deleted. Not enough remaining memory.” appears and the scanned job is deleted if the memory becomes full while scanning a document.



## 5.5 When the message “Please exchange toner.” appears

When there is very little toner remaining, the message “Please exchange toner.” appears.



### Detail

*After the message “Please exchange toner.” appears, about 500 (Letter) pages can be printed.*

*When the message appears, prepare to replace the toner bottle according to your maintenance agreement. When the message “There is no Toner.” appears, the machine stops operating.*



### *When the toner has run out*

When the toner bottle is empty, the message shown below appears. Immediately replace the toner bottle.

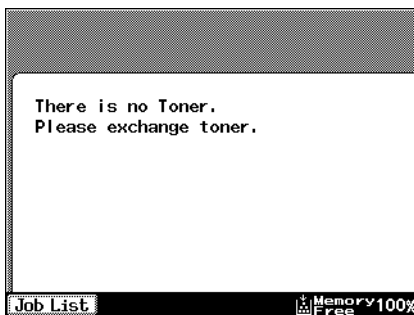

### Detail

*For details on replacing the toner bottle, refer to “Replacing the toner bottle” on page 9-2.*

## 5.6 When the message “Stapler empty.” appears

When the staple cartridge is empty, the message “Stapler empty.” appears.

Replace the staple cartridge.

Example: Message when the finisher has run out of staples

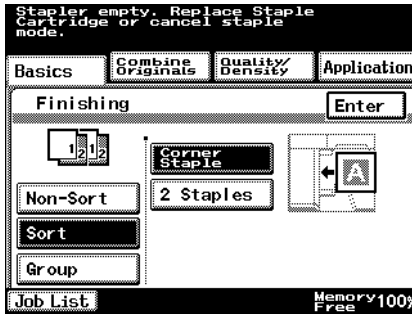

### Reminder

*Be sure to replace the staple cartridge only after the message appears, otherwise the machine may be damaged.*



### Detail

*For details on replacing the staple cartridge, refer to “Replacing the staple cartridge” on page 9-7.*

## 5.7 Basic troubleshooting

	Symptom	Possible cause	Remedy
Main Unit	The machine does not start up when the main power switch is turned on.	Is no power supplied from the electrical outlet?	Correctly insert the power supply plug into the electrical outlet.
		Has the [Power] (auxiliary power) key been turned on?	Turn on the [Power] (auxiliary power) key.
	Copying does not start.	Is the right-side door of the machine open?	Securely close the right-side door of the machine.
		Is there no paper that matches the document?	Load paper of the appropriate size into the paper tray.
	The printed output is too light.	Is the copy density set too light?	Touch [Dark] in the Density screen to copy at the desired copy density. (See page 3-45.)
		Is the paper damp?	Replace the paper with new paper. (See page 2-54, page 2-57 and page 2-60.)
	The printed output is too dark.	Is the copy density set too dark?	Touch [Light] in the Density screen to copy at the desired copy density. (See page 3-45.)
		Was the document not pressed close enough against the original glass?	Position the document so that it is pressed closely against the original glass. (See page 3-10.)
	The printed output is blurry.	Is the paper damp?	Replace the paper with new paper. (See page 2-54, page 2-57 and page 2-60.)
		Was the document not pressed close enough against the original glass?	Position the document so that it is pressed closely against the original glass. (See page 3-10.)
	There are dark specks or spots throughout the printed output. There are streaks in the printed output.	Is the original glass dirty?	Wipe the glass with a soft, dry cloth. (See page 10-3.)
		Is the document transfer belt dirty?	Clean the document transfer belt with a soft cloth dampened with a mild detergent.
		Was the original document printed on highly translucent material, such as diazo photosensitive paper or overhead projector transparencies?	Place a blank sheet of paper on top of the document. (page 3-10.)

	Symptom	Possible cause	Remedy
		Is a double-sided document being copied?	If a thin double-sided document is being copied, the print on the back side may be reproduced in the copy. Select the "Dot Matrix" Density setting. (See page 3-43.)
	The image is not aligned properly on the paper.	Is the document incorrectly positioned?	Correctly position the document against the document scales. (See page 3-10.) Load the document into the ADF, and slide the adjustable document guides to fit the size of the document. (See page 3-8.)
		Is the document incorrectly positioned in the ADF?	If the document cannot be fed correctly through the ADF, make copies by positioning the document on the original glass. (See page 3-10.)
		Is the original glass dirty (while using the ADF)?	Wipe the glass with a soft, dry cloth. (See page 10-3.)
		Are the adjustable document guides incorrectly positioned against the edges of the document?	Slide the adjustable document guides against the edges of the document.
		Was curled paper loaded into the paper tray?	Flatten the paper before loading it.
		The printed page is curled.	Was paper that curls easily (as with recycled paper) used?
	The edge of the printed output is dirty.	Is the document pad dirty?	Clean the document transfer belt with a soft cloth dampened with a mild detergent. (See page 10-5.)
		Was the selected paper size larger than the document (with a Zoom setting of "x1.0")?	Select a paper size that is the same size as the document. Otherwise, select the "Auto Zoom" setting to enlarge the copy to the selected paper size. (See page 3-27.)
		Is the orientation of the document different from the orientation of the paper (with a Zoom setting of "x1.0")?	Select a paper size that is the same size as the document. Otherwise, select a paper orientation that is the same as that of the document.



	Symptom	Possible cause	Remedy
		Was the copy reduced to a size smaller than the paper (with a reduced zoom ratio specified)?	Select a zoom ratio that adjusts the document size to the selected paper size. (See page 3-27.) Otherwise, select the "Auto Zoom" setting to reduce the copy to the selected paper size. (See page 3-27.)
	Even though the paper misfeed was cleared, copies cannot be produced.	Are there paper misfeeds at other locations?	Check the touch panel for other paper misfeed indications, and then remove any misfed paper at all other locations. (See page 5-5.)
	Printing with the "Double-Sided" → "Single-Sided" or "Double-Sided" → "Double-Sided" settings are not possible.	Have settings been selected that cannot be combined?	Check the combinations of the selected settings.
	Copying is not possible even though the password is entered on a machine with user authentication/account track set.	Did the message "Account has reached its maximum copy allowance." appear?	Contact your administrator.
ADF	The document is not fed.	Is the ADF slightly open?	Securely close the ADF.
		Is the document one that does not meet the specifications?	Check that the document is correctly placed on the original glass.
		Is the document correctly loaded?	Position the document correctly. (See page 3-8.)
Finisher	The finisher cannot be used.	Is no power supplied to the connector?	Check that the cord is correctly inserted into the connector.
	The pages cannot be stapled.	Have the staples run out?	Replace the staple cartridge. (See page 9-7.)
	The staple is incorrectly positioned by 90 degrees.	Is the staple position correctly specified?	Specify the desired stapling position. (See page 3-55.)
	The pages that were fed out were not uniformly loaded and the punched holes or staples are incorrectly positioned.	Is the paper curled?	Remove the paper from the paper tray, turn it over, and then load it again.
		Is there a gap between the lateral guides in the paper tray and the sides of the paper?	Slide the lateral guides in the paper tray against the sides of the paper so that there is no gap.
Even though a Punch setting was selected, holes are not punched. (when punch unit is installed on finisher)	Did the message "Remove punch scraps." appear?	Empty the hole-punch waste container.	

If any message other than those listed above appears, perform the operation described in the message.

If the problem is not corrected after the described operation is performed, contact your technical representative.

## 5.8 Main messages and their remedies

Message	Possible cause	Remedy
Original left on glass.	The document was left on the original glass.	Remove the document from the original glass.
Original size cannot be detected. Select paper size.	① The document is not positioned correctly. ② A document with a non-standard size or with a size too small to be detected is loaded.	① Position the document correctly. ② Select the correct paper size.
This mode cannot be set with XXX.	Functions that cannot be used together are selected.	Make copies using only one of the functions.
The Exit Tray has reached its maximum capacity. Please remove all copies from the tray as indicated by the arrow(s).	Since the maximum amount of copies for the indicated finisher output tray has been exceeded, the machine is unable to make copies.	Remove all copies from the indicated tray.
Input User Name and Password to login.	User authentication settings have been specified. Copies cannot be made unless a user name and its correct password are entered.	Type in your user name and password. (See "Controlling machine use with user authentication" on page 2-30.)
Input Account Name and Password to login.	Account track settings have been specified. Copies cannot be made unless an account name and its correct password are entered.	Type in your account name and password. (See "Limiting user access with account track" on page 2-37.)
Account has reached its maximum copy allowance. Please call your administrator	The limit on the number of pages that can be printed has been reached.	Contact your administrator.
Properly close the section(s) indicated by the arrow(s)	Since a machine door or cover is open or an option is not installed correctly, the machine is unable to make copies.	Make sure that all doors and covers are closed and that all options are installed correctly.
Install the imaging Unit	The imaging unit is not installed correctly.	Reinstall the imaging unit or parts, or contact your technical representative.
Replenish paper.	The indicated tray has run out of paper.	Load paper into the indicated tray. For details on loading paper into the paper trays, refer to "Loading paper into the 1st or 2nd tray" on page 2-54, "Loading paper into the LCT" on page 2-57, and "Loading paper into the bypass tray" on page 2-60.

Message	Possible cause	Remedy
Please exchange toner.	The toner is about to run out.	Prepare to replace the toner bottle according to your maintenance agreement.
There is no Toner.	Since the toner has run out, the copier is unable to make copies.	Replace the toner bottle according to your maintenance agreement.
Stapler empty. Replace Staple Cartridge or cancel Staple mode.	The staples have run out.	Replace the staple cartridge. For details on replacing the staple cartridge, refer to "Replacing the staple cartridge" on page 9-7.
Misfeed detected.	Since a paper misfeed occurred, the machine is unable to make copies.	Clear the paper misfeed. See "When the message "Misfeed detected." appears" on page 5-4.
Return the following number of originals to Document Feeder. 22	After clearing a paper misfeed, it is necessary to reload certain pages of the document that have already been fed through the ADF.	Load the indicated document pages into the ADF.
Malfunction detected. Please call your Technical Representative.	The machine malfunctioned and is unable to make copies.	Inform your technical representative of the code displayed on the touch panel.

If any message other than those listed above appears, perform the operation described in the message.



---























A large, bold, black number '6' is centered within a gray rectangular background.





## Specifications

## 6 Specifications

### 6.1 Specifications

#### Copier

Specifications	
Type	Desktop/console
Document holder	Stationary (mirror scanning)
Photoconductor	OPC
Luminous source	Cold cathode tube
Copying system	Digital laser copying
Developing system	HMT developing method (HMT-OR)
Fusing system	Heat-roller-fixing system
Resolution	600 dpi × 600 dpi
Document	Types: Sheets, books (page spreads), and three-dimensional objects Size: Maximum A3 (11 × 17) Weight: Maximum 55-3/4 lb (ADF), 4-1/2 lb (three-dimensional objects)
Paper types	Plain paper (15 to 24 lb), thick paper* (24-1/4 to 55-3/4 lb), thin paper* (13-1/4 to 14-3/4 lb), special paper, overhead projector transparencies*, postcards*, envelopes*, label sheets* *Can only be fed through the bypass tray
Copy sizes	1st and 2nd tray: A3  , B4  to B5  , 8-1/2 × 13  , 11 × 17  to 5-1/2 × 8-1/2   , Legal  , Letter   Bypass tray: A3  , B4  , A4  , B6  , 8-1/2 × 13  , 11 × 17  to 5-1/2 × 8-1/2   , Legal  , Letter   , Executive   Width: 3-1/2 to 11-3/4; Length: 5-1/2 to 17
Paper tray capacity	1st tray: Plain paper: 500 sheets 2nd tray: Plain paper: 500 sheets Bypass tray: Plain paper: 150 sheets; Thick paper: 50 sheets; Overhead projector transparencies/postcards/label sheets: 50 sheets; Envelopes: 10; Thin paper: 150 sheets
Copy output tray capacity	Plain paper: 500 sheets; Thick paper overhead projector transparencies: 20 sheets

Specifications	
Warm-up time	Less than 24 seconds after the machine is turned on with the main power switch (less than 26 seconds if the fax kit or scanner kit is installed) Less than 14 seconds after the [Power] (auxiliary power) key is turned on *At room temperature (73.4°F (23°C))
Image loss	Leading edge: 1/6; Trailing edge: 1/6; Rear edge: 1/6; Front edge: 1/6
First copy	bizhub 222/282: 5.3 seconds or less (with Letter  paper fed from the 1st tray) bizhub 362: 4.8 seconds or less (with Letter  paper fed from the 1st tray)
Copy speed	bizhub 222: 22 ppm (with Letter  ) bizhub 282: 28 ppm (with Letter  ) bizhub 362: 36 ppm (with Letter  )
Magnification ratios	Full size ("×1.0"): ×1.000 Enlarge: ×1.214, ×1.294, ×1.545, ×2.000 Reduce: ×0.785, ×0.733 (can be changed to ×0.772), ×0.647, ×0.500, Minimal (×0.930)* Zoom: ×0.250 to ×4.000 (in 0.001 increments) Stored zoom ratios: 3 **"Minimal" zoom ratio (between ×0.900 and ×0.999)
Multiple copies	1 to 999 sheets
Density control	Manual density adjustment (9 levels) Automatic density adjustment (5 levels)
Power requirements	AC 120 V, 11.5 A +10% or less, 60 Hz
Power consumption	1,380 W ±10% or less
Energy efficiency <sup>*1</sup>	bizhub 222: 20 wh/h, bizhub 282: 27 wh/h, bizhub 362: 31 wh/h
Dimensions	26-3/4 (W) × 28 (D) × 28-1/4 (H)
Space requirements <sup>*2</sup>	39-1/2 (W) × 28 (D)
Memory	Standard memory: 192 MB; For files: 32 MB
Weight	Approx. 163 lb





<sup>\*1</sup> Energy efficiency when the Low Power mode is set to 1 minute and the Sleep mode is set to 1 minute.

<sup>\*2</sup> The indicated spaced requirements represent the space required to fully extend the bypass tray.

In order to incorporate improvements, these product specifications are subject to change without notice.



## Automatic Duplex Unit

Specifications	
Paper types	Plain paper (15 to 24 lb)
Paper sizes	11 × 17  , Legal  , Letter  /  , 5-1/2 × 8-1/2 
Power requirements	Supplied from main unit
Power consumption	Less than 10 W
Dimensions	3-1/2 (W) × 16-1/2 (D) × 14 (H)
Weight	Approx. 4-3/4 lb

## Reverse Automatic Document Feeder DF-620

















Specifications	
Document feed methods	Standard methods: Single-sided and double-sided documents “Mixed Original” function: Combination of single-sided and double-sided documents
Document types	Single-sided: Plain Paper (9-1/4 to 34 lb) Double-sided or mixed: Plain Paper (13-1/4 to 34 lb)
Document sizes	Single-sided/double-sided documents: 11 × 17  , Legal  , Letter  /  , 5-1/2 × 8-1/2  Mixed document sizes: Refer to Table 1.
Capacity of document feeder	Single-sided/double-sided documents: Maximum 80 sheets (21-1/4 lb)
Power requirements	Supplied from main unit
Power consumption	Less than 48 W
Dimensions	23 (W) × 22 (D) × 5-3/4 (H)
Weight	Approx. 20-3/4 lb





Table 1: Possible combinations for mixed document sizes

Maximum Document Width → ↓ Document Size	11 × 17 	Letter 	Legal 	Letter 	5-1/2 × 8-1/2 	5-1/2 × 8-1/2 
11 × 17 	○	○	—	—	—	—
Letter 	○	○	—	—	—	—
Legal 	○	○	○	○	○	—
Letter 	○	○	○	○	○	—
5-1/2 × 8-1/2 	—	—	○	○	○	—
5-1/2 × 8-1/2 	—	—	—	—	—	○





○: Possible

—: Not possible

### Paper Feed Cabinet PC-108

Specifications	
Paper types	Plain paper (15 to 24 lb)
Paper sizes	11 × 17  , Legal  , Letter  /  , 5-1/2 × 8-1/2 
Paper tray capacity	3rd tray: 500 sheets (21-1/4 lb)
Power requirements	Supplied from main unit
Power consumption	Less than 15 W
Dimensions	22-1/2 (W) × 22-3/4 (D) × 11-3/4 (H)
Weight	Approx. 54-1/2 lb
Unit structure	1 paper tray







### Paper Feed Cabinet PC-206

Specifications	
Paper types	Plain paper (15 to 24 lb)
Paper sizes	11 × 17  , Legal  , Letter  /  , 5-1/2 × 8-1/2 
Paper tray capacity	Upper tray (3rd tray): 500 sheets (21-1/4 lb) Lower tray (4th tray): 500 sheets (21-1/4 lb)
Power requirements	Supplied from main unit
Power consumption	Less than 15 W
Dimensions	22-1/2 (W) × 22-3/4 (D) × 11-3/4 (H)
Weight	Approx. 57-1/4 lb
Unit structure	2 paper trays

### Paper Feed Cabinet PC-407

Specifications	
Paper types	Plain paper (15 to 24 lb)
Paper sizes	Letter 
Paper tray capacity	2,500 sheets (21-1/4 lb)
Power requirements	Supplied from main unit
Power consumption	Less than 45 W
Dimensions	22-1/2 (W) × 22-3/4 (D) × 11-3/4 (H)
Weight	Approx. 57-1/4 lb

**Finisher FS-530**

Specifications	
Output trays	Output tray 1, output tray 2
Feed settings	“Non-Sort”, “Sort”, “Group”, Staple settings, and Punch settings
Paper types	Output tray 1: Plain paper (15 to 24 lb) Thick paper (24-1/4 to 55-3/4 lb), overhead projector transparencies, postcards, envelopes, label sheets Punch settings: Plain paper (16 to 24 lb) Output tray 2: Plain paper (15 to 24 lb) Staple settings: Plain paper (15 to 24 lb) Punch settings: Plain paper (16 to 24 lb)
Paper sizes	11 × 17, 11 × 14, Legal  , Letter  , 5-1/2 × 8-1/2 
Paper capacity	Output tray 1: Plain paper (15 to 24 lb): 200 sheets Thick paper (24-1/4 to 55-3/4 lb), overhead projector transparencies, postcards, envelopes, or label sheets: 20 sheets Output tray 2: Plain paper (21-1/4 lb): 1,000 single-sided sheets, 500 double-sided sheets
Amount of shift	1-1/4
Staple settings	Paper sizes (no. of bound pages): 11 × 17, 11 × 14, Legal  , Letter  , 5-1/2 × 8-1/2  (2 to 50 pages)
Punch settings	Paper sizes: 11 × 17, Letter  Number of punched holes: 2, 3
Power requirements	Supplied from main unit
Power consumption	Less than 66 W
Dimensions	12-1/2 (W) × 22 (D) × 22-1/2 (H) When the tray is pulled out: 17-1/4 (W)
Weight	Approx. 47-1/4 lb (including the horizontal transport unit)
Consumables	Staples MS-5D (5,000 staples for stapling 50 sheets) × 2

## Punch Unit PU-501

Specifications	
Punched holes	2 holes or 3 holes
Paper types	Plain paper (16 to 24 lb)
Paper sizes	11 × 17, Letter <input type="checkbox"/> / <input type="checkbox"/>
Power requirements	Supplied from finisher
Dimensions	4-1/2 (W) × 18-1/4 (D) × 5-1/4 (H)
Weight	Approx. 4-1/4 lb

## Saddle Stitcher SD-507

Specifications	
Number of bins	1 bin
Paper types	Plain paper (15 to 24 lb)
Paper sizes	11 × 17, Letter <input type="checkbox"/>
Paper capacity	Plain paper (15 to 24 lb): Maximum 200 sheets or 20 sets
Staple settings	Number of bound pages: 2 to 15 sheets
Dimensions	17-1/2 (W) × 8 (D) × 18-3/4 (H) When the tray is pulled out: 22-3/4 (W) × 11 (D)
Weight	20-1/2 lb
Consumables	MS-2C cartridge (for 2,000) × 1
Power requirements	Supplied from finisher

## Output Tray OT-602

Specifications	
Number of bins	1 bin
Paper capacity	Plain paper (15 to 24 lb): Maximum 200 sheets Postcards, envelopes, overhead projector transparencies, or label sheets: Maximum 20 sheets
Dimensions	11 (W) × 14-1/2 (D) × 2-1/4 (H)
Weight	Approx. 1-1/2 lb

**Mailbin Kit MT-502**

Specifications	
Number of bins	4 bins
Paper types	Plain paper (15 to 24 lb)
Paper sizes	Letter <input type="checkbox"/> , 5-1/2 × 8-1/2 <input type="checkbox"/>
Paper capacity	Maximum 125 sheets (21-1/4 lb) per bin
Dimensions	24-1/2 (W) × 19-3/4 (D) × 15-1/4 (H)
Weight	Approx. 17-1/2 lb (unit weight); Approx. 26-1/2 lb or less (gross weight)
Power requirements	Supplied from finisher

**Job Separator JS-502**

Specifications	
Number of bins	1 bin
Paper types	Plain paper (15 to 24 lb), thick paper (24-1/4 to 56 lb), overhead projector transparencies, postcards, envelopes, label sheets, thin paper (13-1/4 to 14-3/4 lb)
Paper sizes	11 × 17, 11 × 14, Legal <input type="checkbox"/> , Letter <input type="checkbox"/> / <input type="checkbox"/> , 5-1/2 × 8-1/2 <input type="checkbox"/> / <input type="checkbox"/>
Paper capacity	100 sheets
Dimensions	17-3/4 (W) × 17-1/2 (D) × 3 (H)
Weight	Approx. 3-3/4 lb



---



## **Copy paper/original documents**



## 7 Copy paper/original documents

### 7.1 Copy paper

Use paper that meets the following specifications.

#### Possible paper sizes

Non-standard-sized paper:

Paper source	Paper width	Paper length
Bypass tray	3-1/2 to 11-3/4	5-1/2 to 17
1st tray	—	—
2nd tray		
3rd tray		
4th tray		
LCT		
Double-sided copies	—	—

Standard-sized paper:

Paper source	Paper size
Bypass tray	A3 ☐, B4 ☐, A4 ☐, B6 ☐, 8-1/2 × 13 ☐, 11 × 17 ☐ to 5-1/2 × 8-1/2 ☐/☐, Legal ☐, Letter ☐/☐, Executive ☐/☐
1st tray	A3 ☐, B4 ☐ to B5 ☐, 8-1/2 × 13 ☐, 11 × 17 ☐ to 5-1/2 × 8-1/2 ☐/☐, Legal ☐, Letter ☐/☐
2nd tray	
3rd tray	11 × 17 ☐, Legal ☐, Letter ☐/☐, 5-1/2 × 8-1/2 ☐
4th tray	
LCT	Letter ☐
Double-sided copies	11 × 17 ☐, Legal ☐, Letter ☐/☐, 5-1/2 × 8-1/2 ☐

Loaded equipment	Paper sizes that can be loaded
Finisher (FS-530)	Output tray 1, 2 and optional output tray 3-1/2 × 5-1/2 to 11-3/4 × 17
Output tray (OT-602)	"Group"/"Sort" settings: 7-1/4 × 5-1/2 to 11-3/4 × 17 Staple settings: 7-1/4 × 7-1/4 to 11-3/4 × 17 Punch settings: 8-1/2 × 7-3/16 to 11-11/16 × 17 (with the "2-Hole" punch setting), 11 × 7-3/16 to 11-11/16 × 17 (with the "3-Hole" punch setting) <sup>2</sup>

Loaded equipment	Paper sizes that can be loaded
Saddle stitcher (SD-507)	Folding/binding: A3 ☐, B4 ☐, A4 ☐, B5 ☐, 11 × 17 ☐, 11 × 14 ☐, Letter ☐, 7-1/4 × 10 to 11-3/4 × 17
Mailbin kit (MT-502)	7-1/4 × 7-1/4 to 11-3/4 × 11-3/4 Punch settings: 7-1/4 × 7-1/4 to 11-3/4 × 11-3/4 (with the “2-Hole” punch setting), 11 × 7-1/6 to 17 × 17 (with the “3-Hole” punch setting) <sup>*2</sup>
Job separator (JS-502)	11 × 17 ☐, 11 × 14 ☐, Legal ☐, Letter ☐/☐, 5-1/2 × 8-1/2 ☐/☐
Copy output tray (standard)	A3 ☐, B4 ☐ to A5 ☐, A6 ☐, 8-1/2 × 13 ☐ <sup>*1</sup> , 11 × 17 ☐, 11 × 14 ☐, Legal ☐, Letter ☐/☐, Executive ☐/☐, Invoice ☐/☐, non-standard sizes, 5-1/2 × 8-1/2 ☐/☐

<sup>\*1</sup> There are four Foolscap sizes: 8-1/2 × 13 ☐<sup>\*1</sup>, 8-1/4 × 13 ☐<sup>\*1</sup>, 8 × 13 ☐<sup>\*1</sup> and 8-5/8 × 13 ☐<sup>\*1</sup>. Any one of these sizes can be selected. For details, contact your technical representative.

<sup>\*2</sup> Can be used when optional punch unit is installed on finisher







## Paper types and paper capacities

Paper type	Plain paper	Thick paper	Thin paper	Recycled paper
Weight (lb)	15 lb to 24 lb	24-1/4 lb to 55-3/4 lb	13-1/4 lb to 14-3/4 lb	15 lb to 24 lb
Paper source				
Bypass tray	150 sheets	50 sheets	150 sheets	150 sheets
1st tray	500 sheets	—	—	500 sheets
2nd tray	500 sheets			500 sheets
3rd tray	500 sheets			500 sheets
4th tray	500 sheets			500 sheets
LCT	2,500 sheets			2,500 sheets
Double-sided copies	○	—	—	○

Paper type	Overhead projector transparencies	Postcards	Envelopes	Label sheets
Paper source				
Bypass tray	50 sheets	50 sheets	10 sheets	50 sheets
1st tray	—	—	—	—
2nd tray				
3rd tray				
4th tray				
LCT				
Double-sided copies	—	—	—	—

## Special paper

Paper other than plain paper, such as overhead projector transparencies and recycled paper, is called special paper. Be sure to select a special paper setting for paper trays loaded with media such as overhead projector transparencies and recycled paper in order to prevent operating errors.

Paper type	Icon	Description
OHP		Select this setting when overhead projector transparencies are loaded. A paper tray with this setting is not automatically selected when the "Auto Paper Select" setting is specified or when the paper trays are switched automatically.
Thick		Select this setting when thick paper with a weight of 24-1/4 lb to 55-3/4 lb is loaded. A paper tray with this setting is not automatically selected when the "Auto Paper Select" setting is specified or when the paper trays are switched automatically.
Thin		Select this setting when thin paper with a weight of 13-1/4 lb to 14-3/4 lb is loaded. A paper tray with this setting is not automatically selected when the "Auto Paper Select" setting is specified or when the paper trays are switched automatically.
Envelope		Select this setting when envelopes are loaded. A paper tray with this setting is not automatically selected when the "Auto Paper Select" setting is specified or when the paper trays are switched automatically.
Single Sided Only		Select this setting when the paper that is loaded should not be used with double-sided copying (for example, when one side has already been printed on). A paper tray with this setting is given priority when the "Auto Paper Select" setting is specified. A paper tray with this setting is not automatically selected during double-sided copying.
Recycled		Select this setting when the paper that is loaded should not be given priority, for example, when recycled paper is loaded. A paper tray with this setting is not automatically selected when the "Auto Paper Select" setting is specified.
Special Paper		Select this setting when the paper that is loaded is from a particular manufacturer or special paper that is not usually used. A paper tray with this setting is not automatically selected when the "Auto Paper Select" setting is specified or when the paper trays are switched automatically.

**Detail**

*The available special paper settings differ for each paper tray.*

*The settings for overhead projector transparencies, thick paper, thin paper and envelopes can be specified only for the bypass tray. For details on specifying the settings for overhead projector transparencies, thick paper, thin paper and envelopes for the bypass tray, refer to “To specify a setting for special paper (Change Setting)” on page 7-15.*

*For details on specifying the settings for paper only for single-sided copying, for recycled paper and for special paper, refer to “Special Paper Setting” on page 11-12.*

**Precautions for paper**

The following types of paper should not be used, otherwise decreased print quality, paper misfeeds or damage to the machine may occur.

- Overhead projector transparencies that have already been fed through the machine (even if the transparency is still blank)
- Paper that has been printed on by a heat-transfer printer or an inkjet printer
- Paper that is either extremely thick or extremely thin
- Folded, curled, wrinkled, or torn paper
- Paper that has been left unwrapped for a long period of time
- Damp paper, perforated paper, or paper with punched holes
- Extremely smooth or extremely rough paper, or paper with an uneven surface
- Paper that has been treated, such as carbon-backed, heat-sensitive or pressure-sensitive paper
- Paper that has been decorated with foil or embossing
- Paper of a non-standard shape (not rectangular)
- Paper that is bound with glue, staples or paper clips
- Paper with labels attached
- Paper with ribbons, hooks, buttons, etc., attached

**Paper storage**

Observe the following precautions when storing the paper.

- Store paper in a cool, dark location with little humidity.
- If the paper becomes damp, paper misfeeds may occur. Paper that has not been loaded should be kept wrapped or placed in a plastic bag and stored in a cool, dark location with little humidity.
- Store the paper laying flat, not standing on its edge. Curled paper may cause paper misfeeds.
- Keep paper out of the reach of children.

### **Automatic paper-tray-switching feature**

If the selected paper tray runs out of paper while a job is being printed and a different paper tray is loaded with paper meeting the following conditions, the other paper tray is automatically selected so printing can continue. If the optional LCT is installed, a maximum of 3,650 copies (with Letter  paper) can be made continuously.

#### **Operating Conditions**

- The paper is the same size.
- The paper is positioned in the same orientation.
- The paper is the same type.

### **Order for selecting the paper trays**

As a factory default, when a different paper tray is automatically selected, the next paper tray in the following list is chosen.

1st tray → 2nd tray → 3rd tray/LCT → 4th tray → Bypass tray

## 7.2 Specifying paper settings for the bypass tray

This section describes the procedures for specifying the size and type of paper loaded in the bypass tray.



### Detail

For details on loading the paper into the bypass tray, refer to “Loading paper into the bypass tray” on page 2-60.

### To specify the paper size (Change Setting)

Standard paper sizes can be specified for the paper loaded into the bypass tray.

This is useful, for example, when the size of the paper that is loaded cannot be automatically detected (such as with paper in inch sizes).

1 Load the paper into the bypass tray.

2 In the Basics screen, touch [Paper].

The Paper screen appears.



3 Select the button for the bypass tray.

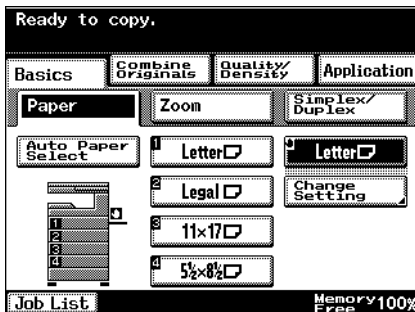

4 Touch [Change Setting].

- 5 Select the size of paper loaded into the bypass tray.

? How can the size of paper loaded into the bypass tray be selected?

→ For details, refer to “To specify a setting for special paper (Change Setting)” on page 7-15.

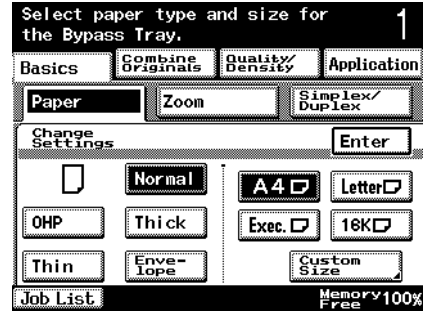

- 6 Touch [Enter].

The Paper screen appears again.  
The paper size for the bypass tray is set.



#### Reminder

*If paper other than the specified paper size is loaded, a paper misfeed may occur since the paper size is not automatically detected.*



## To specify a non-standard paper size (Custom Size settings)

Non-standard-sized paper can be loaded only into the bypass tray.

If non-standard-sized paper is loaded, it will be necessary to specify the paper size.

- 1 In the Basics screen, touch [Paper].  
The Paper screen appears.



- 2 Select the button for the bypass tray.

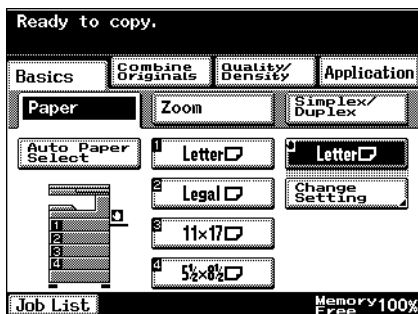

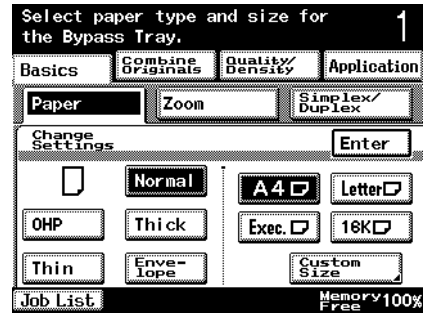

- 3 Touch [Change Setting].

- 4 Touch [Custom Size].  
The Custom Size screen appears.



- ? How can the size of paper loaded into the bypass tray be selected?  
→ For details, refer to “To specify a setting for special paper (Change Setting)” on page 7-15.

- 5 Type in the length (X) and width (Y) of the paper.

- Make sure that [X] is selected, and then use the keypad to type in the length of side X (between 5.50 and 17.00).
- Touch [Y] to select it, and then use the keypad to type in the length of side Y (between 3.56 and 11.68).
- If “Inch (Fraction)” was selected as the measurement units, touch [X] or [Y] to position the cursor in the input box, and then touch  or  to specify the length.
- A value outside the allowable range cannot be entered.
- To change the entered value, press the [C] (clear) key, and then enter the correct value.

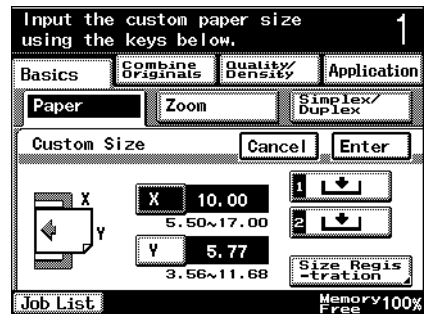

- ? Can paper sizes be stored?  
→ Two specified non-standard paper sizes can be stored. For details, refer to “To store a non-standard paper size (Custom Size settings)” on page 7-12.  
→ To recall a stored paper size, touch [1] or [2].

- 6 Touch [Enter].

The Paper screen appears again.  
A non-standard paper size is specified.

## To store a non-standard paper size (Custom Size settings)

Two non-standard paper sizes for the bypass tray can be stored.

Storing paper sizes that are used often allows the paper size to be quickly selected, without having to re-enter the setting.

- 1 In the Basics screen, touch [Paper].  
The Paper screen appears.



- 2 Select the button for the bypass tray.

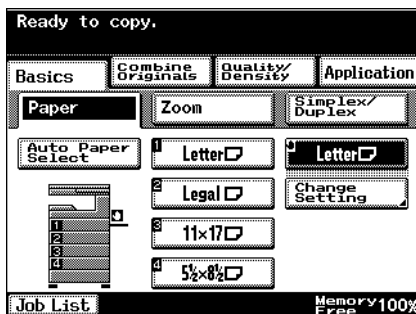

- 3 Touch [Change Setting].

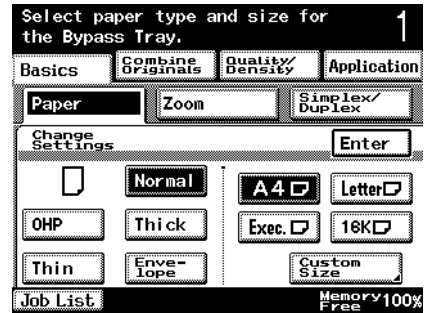

- 4 Touch [Custom Size].  
The Custom Size screen appears.

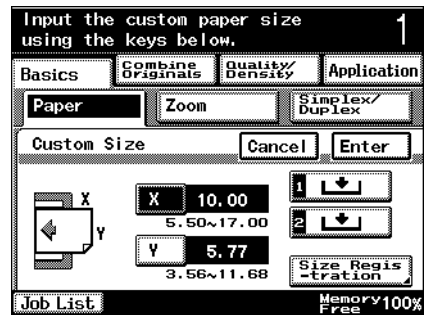

- ? How can the size of paper loaded into the bypass tray be selected?  
→ For details, refer to “To specify a setting for special paper (Change Setting)” on page 7-15.

- 5 Touch [Size Registration].  
The Size Registration screen appears.



- 6 Type in the length (X) and width (Y) of the paper.
- Make sure that [X] is selected, and then use the keypad to type in the length of side X (between 5.50 and 17.00).
  - Touch [Y] to select it, and then use the keypad to type in the length of side Y (between 3.56 and 11.68).
  - If “Inch (Fraction)” was selected as the measurement units, touch [X] or [Y] to position the cursor in the input box, and then touch  or  to specify the length.
  - A value outside the allowable range cannot be entered.

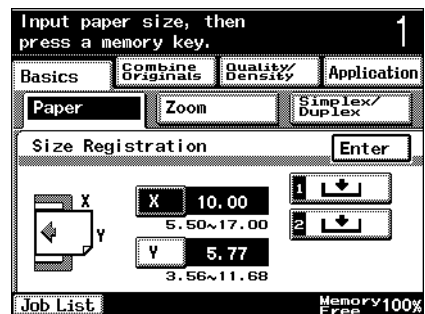

- To change the entered value, press the [C] (clear) key, and then enter the correct value.

7 Touch [1] or [2] to specify where the size is to be stored.

- If a button is pressed where no size is stored, the stored paper size appears on the button to indicate that a size has been stored.

No program registered

Program registered



? How is the stored paper size recalled?

- Touch [1] or [2] in the Custom Size screen to recall the stored paper size.

8 Touch [Enter], and then touch [Enter] in the next screen that appears.

The Paper screen appears again.

The non-standard paper size is stored.

## To specify a setting for special paper (Change Setting)

If a setting for special paper, such as overhead projector transparencies and other special paper, is selected for a paper tray, that tray is not selected automatically with the “Auto Paper Select” setting or the automatic paper-tray-switching feature. However, a paper tray set to “Single Sided Only” is given priority when the “Auto Paper Select” setting is specified.

The following procedure describes how to specify the setting for overhead projector transparencies, thick paper, thin paper or envelopes loaded into the bypass tray.

- 1 In the Basics screen, touch [Paper].  
The Paper screen appears.



- 2 Select the button for the bypass tray.

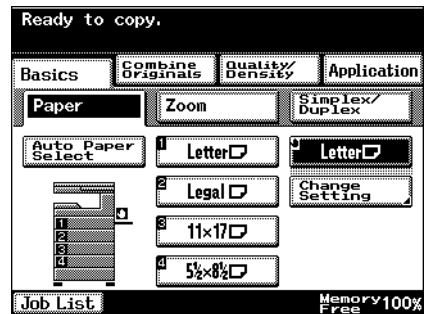

- 3 Touch [Change Setting].

- 4 Select the desired special paper type.

? What types of paper can be loaded into each paper tray?

→ There are limits on the types of paper that can be loaded in a paper tray. For details on the types of paper that can be loaded, refer to “Specifications” on page 6-2 and “Paper types and paper capacities” on page 7-4.

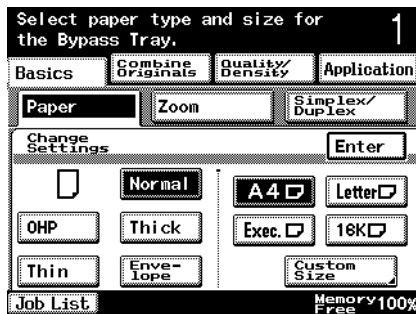

- 5 Touch [Enter].

The Paper screen appears again.

The paper type for the bypass tray is set.



#### Reminder

*If overhead projector transparencies or thick paper is loaded into the bypass tray, be sure to select the corresponding paper type, otherwise a paper misfeed may occur.*



#### Detail

*For details on the special paper, refer to “Special paper” on page 7-5.*

*For details on specifying the settings for paper only for single-sided copying, for recycled paper and for special paper, refer to “Special Paper Setting” on page 11-12.*

*The settings for overhead projector transparencies, thick paper, thin paper and envelopes can also be specified for the bypass tray, even if a setting for paper only for single-sided copying, for recycled paper and for special paper is specified.*

## 7.3 Original documents

When making copies, load the document into the ADF or position it on the original glass.

To copy documents that cannot be loaded into the ADF, position them on the original glass.



### Documents that can be loaded into the ADF

There are two methods for using the ADF.

- Normal method
- For documents of mixed sizes

There are limits on the types of documents that can be loaded with each method.

#### Normal method

	Single-sided documents	Double-sided documents
Document paper type/ Weight	Plain paper: 9-1/4 lb to 34 lb	Plain paper: 13-1/4 lb to 34 lb
Document size	11 × 17  to 5-1/2 × 8-1/2 	
Paper capacity	80 sheets (21-1/4 lb paper)	

#### For documents of mixed sizes

	Single-sided documents	Double-sided documents
Document paper type/ Weight	Plain paper: 13-1/4 lb to 34 lb	
Document size	Refer to "Copying documents of mixed sizes ("Mixed Original" setting)" on page 3-16.	
Paper capacity	80 sheets (21-1/4 lb paper)	



## Precautions for loading documents into the ADF

The following types of documents should not be loaded into the ADF, otherwise paper misfeeds or damage to the document may occur.

- Wrinkled, folded, curled, or torn documents
- Highly translucent or transparent documents, such as overhead transparencies or diazo photosensitive paper
- Coated documents such as carbon-backed paper
- Documents printed on paper thicker than 34-1/4 lb
- Documents that are bound, for example, with staples or paper clips
- Documents that are bound in a book or booklet
- Documents that are bound together with glue
- Document pages that have had cutouts removed or are cutouts
- Label sheets
- Offset printing masters
- Documents with binder holes
- Documents that have just been printed with this machine



### **Reminder**

*Before loading folded documents, such as those folded in half or in a zig-zag, into the ADF, be sure to flatten the pages.*

## Documents that can be placed on the original glass

To copy documents that cannot be loaded into the ADF, position them on the original glass.

	Original glass documents
Document type	Sheets, books (page spreads), three-dimensional objects
Document size	11 × 17  or less
Maximum weight	4-1/2 lb

## Precautions for positioning documents on the original glass

Observe the following precautions when placing the document on the original glass.

- The size of documents printed on paper in metric sizes (such as A3, B4 and A4) cannot be automatically detected. The setting must be specified by the technical representative. For details, contact the technical representative.
- If a document of non-standard paper size is loaded, the “Auto Paper Select” and “Auto Zoom” settings cannot be used since the document size cannot be detected automatically. If a document of non-standard paper size is loaded, select the size of the paper to be copied.
- If highly translucent or transparent documents, such as overhead transparencies or diazo photosensitive paper, are loaded, the document size cannot be detected automatically. Place a blank sheet of paper of the same size over the document.
- Do not place objects exceeding 4-1/2 lb on the original glass, otherwise the original glass may be damaged.
- If a book is placed on the original glass, do not press it down extremely hard, otherwise the original glass may be damaged.





# Application functions

## 8 Application functions

### 8.1 Adding cover pages (“Cover Mode” function)

Specify the paper to be used for the cover pages and add front and back cover pages to the copies.

In addition, the first and last pages of the document can be copied onto the cover pages.

Cover page	Setting	Description
Front Cover	With Image	The first page of the document is copied onto the front cover page.
	Blank	The front cover page is added at the beginning of the copy.
Back Cover	None	A back cover page is not added.
	With Image	The last page of the document is copied onto the back cover page.
	Blank	The back cover page is added at the end of the copy.

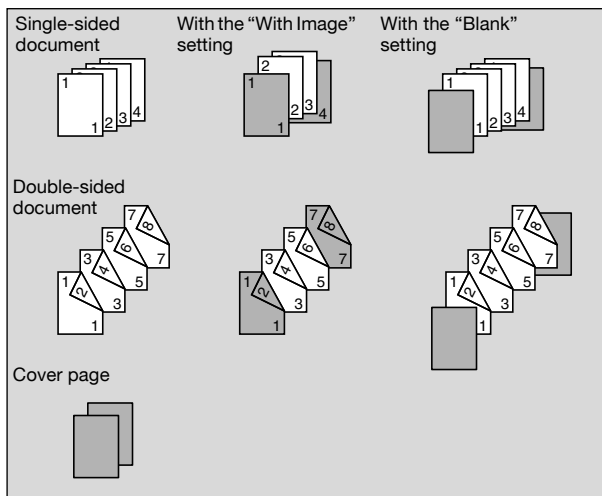

## To copy using the “Cover Mode” function

- ✓ The “Cover Mode” function can be used only if the ADF is installed.

- 1 Load the document into the ADF.
  - For details on positioning the document, refer to “Feeding the document” on page 3-8.
  - If the document contains more than 80 pages, refer to “Scanning a document in separate batches (“Separate Scan” setting)” on page 3-12.
- 2 Load the paper for the cover pages and the paper for the main body of the document into separate paper trays.
  - Use paper with the same size for the cover pages and for the main body of the document, and load them in the same orientation.

- 3 Touch [Application], and then touch [Cover Mode].



- For details on loading paper when using thick paper for the cover pages, refer to “Paper types and paper capacities” on page 7-4 and “Loading paper into the bypass tray” on page 2-60.

The Cover Mode screen appears.

- 4 Select the desired cover page settings.
  - To cancel the “Cover Mode” function, touch [OFF].

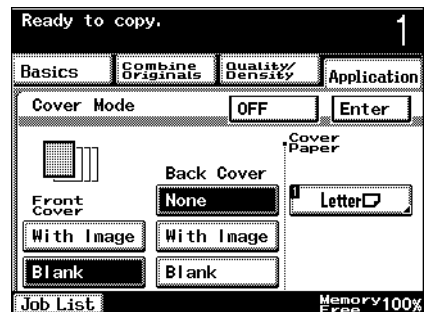

- 5 Touch the button under “Cover Paper”.

The Cover Paper screen appears.

- 6 Select the paper tray loaded with the paper for the cover pages.

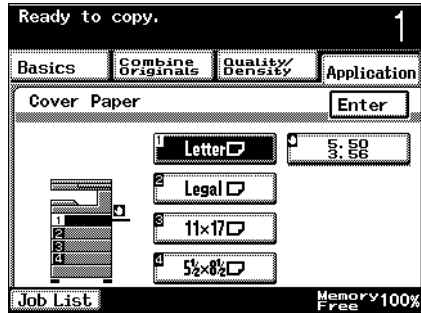

- 7 Touch [Enter], and then touch [Enter] in the next screen that appears.

- 8 Specify any other desired copy settings.

- 9 Using the keypad, type in the desired number of copies.

- 10 Press the [Start] key.  
Copying begins.

## 8.2 Inserting cover pages (“Insert Sheet” function)

Paper, such as colored paper, can be inserted into the copy as an insertion sheet.

Select either “With Image” or “Blank” to specify whether or not a page of the document is copied onto the insertion sheet.

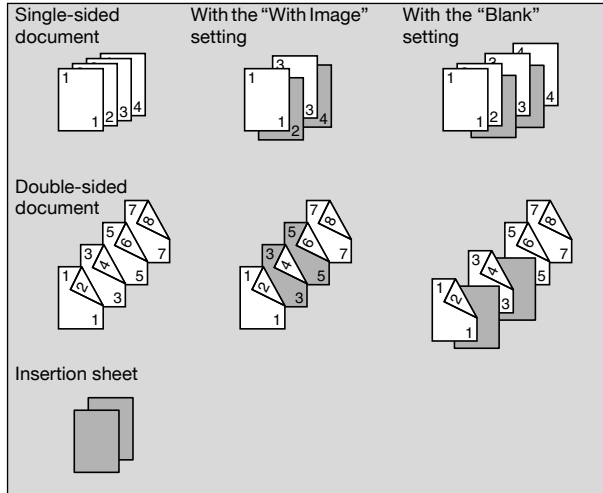



## To copy using the “Insert Sheet” function

- ✓ The “Insert Sheet” function can be used only if the ADF is installed.

- 1 Insert a separator at the desired locations of the insertion sheets, and then load the document into the ADF.

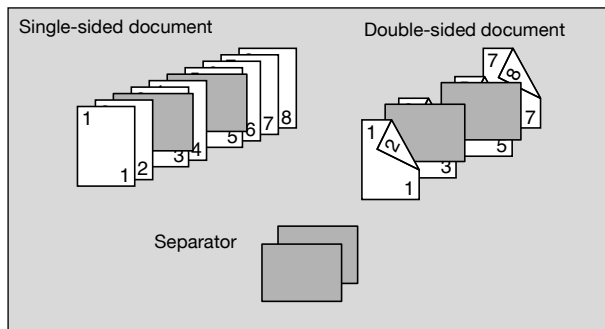

- Insert paper separators with a different width than the document at the desired locations for the insertion sheets.
- For details on positioning the document, refer to “Copying documents of mixed sizes (“Mixed Original” setting)” on page 3-16.
- If the document contains more than 80 pages, refer to “Scanning a document in separate batches (“Separate Scan” setting)” on page 3-12.

- 2 Load the paper for the insertion sheets and the paper for the main body of the document into separate paper trays.

- Use paper with the same size for the insertion sheets and for the main body of the document, and load them in the same orientation.

- 3 Touch [Application], and then touch [Insert Sheet].

- For details on loading paper when using thick paper for the insertion sheets, refer to “Paper types and paper capacities” on page 7-4 and “Loading paper into the bypass tray” on page 2-60.

The Insert Sheet screen appears.

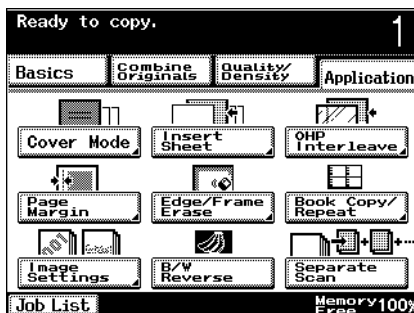

4 Touch either [With Image] or [Blank].

- If “With Image” is selected, the page after the inserted separator is copied onto the insertion sheet. With double-sided copying, the two pages after the separator are copied onto the two sides of the insertion sheet.
- If “Blank” is selected, the insertion sheet is added at the location where the separator was inserted.
- To cancel the “Insert Sheet” function, touch [OFF].

5 Touch the button under “Insert Paper”.

The Cover Paper screen appears.

6 Select the paper tray loaded with the paper for the insertion sheets.

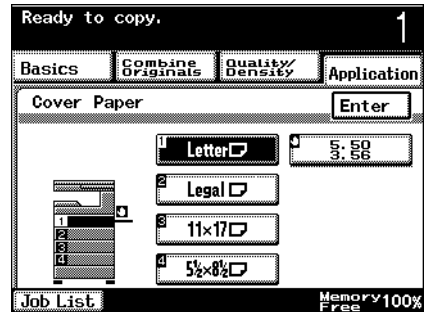
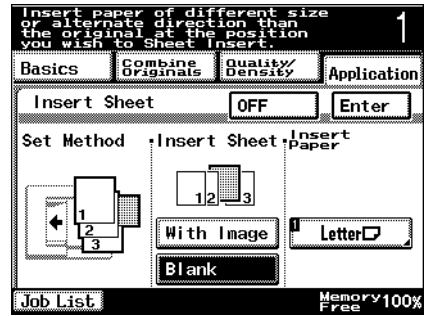

7 Touch [Enter], and then touch [Enter] in the next screen that appears.

8 Specify any other desired copy settings.

9 Using the keypad, type in the desired number of copies.

10 Press the [Start] key.

Copying begins.

### 8.3 Inserting paper between overhead projector transparencies (“OHP Interleave” function)

In order to prevent copies printed onto overhead projector transparencies from sticking together as a result of the heat that is produced during copying, paper (interleaves) can be inserted between the transparencies.

Select either “With Image” or “Blank” to specify whether or not the copy is printed onto the interleaves.

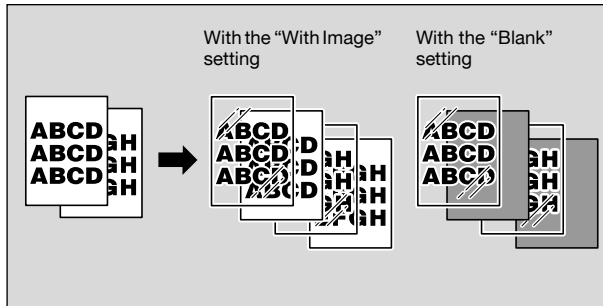

#### To copy using the “OHP Interleave” function

- ✓ No Finishing setting can be used.
- ✓ The number of copies is set to “1” and cannot be changed.

- 1 Position the document to be copied.
  - For details on positioning the document, refer to “Feeding the document” on page 3-8.
- 2 Load the overhead projector transparencies into the bypass tray, and load the interleaf paper into the desired paper tray.
  - For details on loading overhead projector transparencies, refer to “Paper types and paper capacities” on page 7-4, “Loading paper into the bypass tray” on page 2-60, and “To specify a setting for special paper (Change Setting)” on page 7-15.
  - Use interleaf paper with the same size as the overhead projector transparencies, and load them in the same orientation as the transparencies.

- 3 Touch [Application], and then touch [OHP Interleave].

The OHP Interleave screen appears.

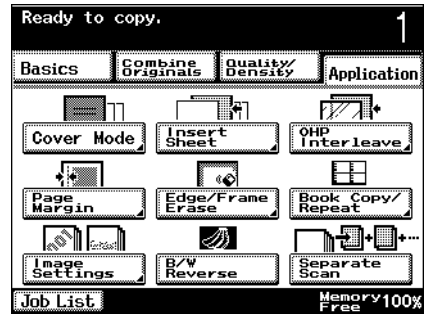

- 4 Touch either [With Image] or [Blank].
- If "With Image" is selected, the interleaves are inserted, alternating with overhead projector transparencies, and the same document page is printed on a transparency and an interleaf.



- If "Blank" is selected, blank interleaves are inserted between the overhead projector transparencies.
- To cancel the "OHP Interleave" function, touch [OFF].

- 5 Touch the button under "Interleaving Paper".

- 6 Select the paper tray loaded with the interleaf paper.

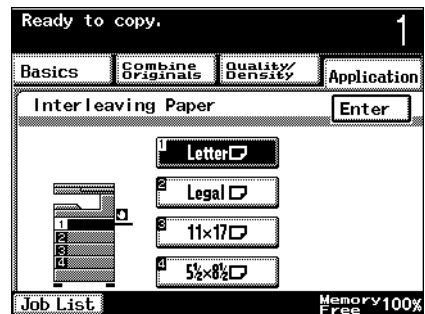

- 7 Touch [Enter], and then touch [Enter] in the next screen that appears.

- 8 Specify any other desired copy settings.
- 9 Press the [Start] key.  
Copying begins.

## 8.4 Adding filing margins to copies (“Page Margin” function)

Copies can be printed with a filing margin so they can easily be stored in filing binders. When making double-sided copies while using the “Page Margin” function, the orientation of the copied image can be adjusted for the position of the filing margin. In addition, the image orientation can be adjusted without creating a filing margin.

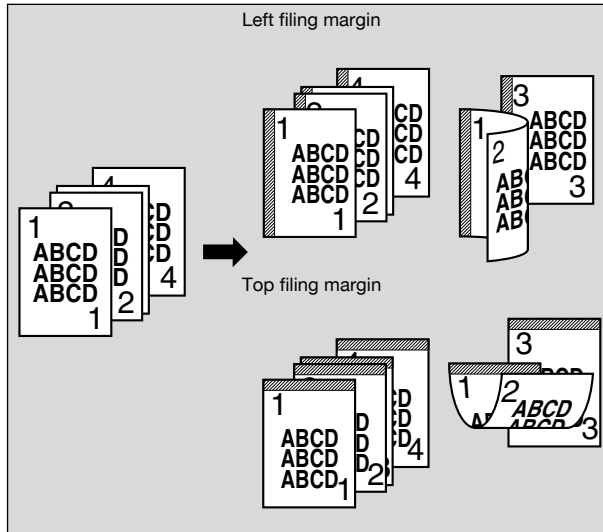

### To copy using the “Page Margin” function

- 1 Position the document to be copied.
  - For details on positioning the document, refer to “Feeding the document” on page 3-8.
- 2 Touch [Application], and then touch [Page Margin].

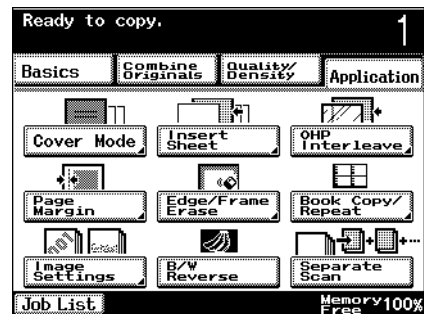

The Page Margin screen appears.



3 Select the position of the filing margin.

- Touch the button for a left filing margin or for a top filing margin.
- To cancel the “Page Margin” function, touch [OFF].



4 Touch  and  to specify the width of the filing margin.

? Can only the orientation of the image be adjusted?

- Set the width of the filing margin to 0 to adjust only the orientation of the image during double-sided copying.  
The margin position can be changed without changing the margin width.

5 Touch [Enter].

6 Specify any other desired copy settings.

7 Using the keypad, type in the desired number of copies.

8 Press the [Start] key.

Copying begins.



**Note**

*The filing margin position indicates the position on each document page.*

## 8.5 Erasing unwanted areas of copies (“Edge/Frame Erase” function)

Copies can be produced by erasing unwanted areas around the document, such as the transmission information on received faxes and the shadows of punched holes.

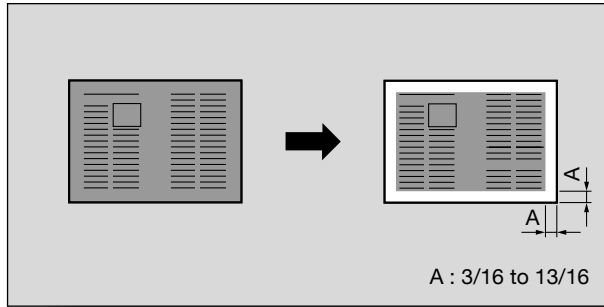

### To copy using the “Edge/Frame Erase” function

- 1 Position the document to be copied.
  - For details on positioning the document, refer to “Feeding the document” on page 3-8.
- 2 Touch [Application], and then touch [Edge/Frame Erase].

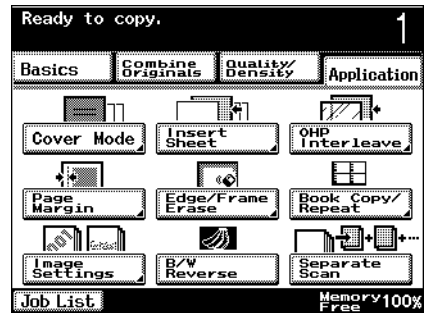

The Edge/Frame Erase screen appears.





- 3 Specify the area to be erased.
- Touch the button for erasing the left side, the top, or a surrounding frame.
  - To cancel the “Edge/Frame Erase” function, touch [OFF].



- 4 Touch  and  to specify the width of the area to be erased.
- 5 Touch [Enter].
- 6 Specify any other desired copy settings.
- 7 Using the keypad, type in the desired number of copies.
- 8 Press the [Start] key.
- Copying begins.



**Note**

*If the frame is selected, the same width is erased on all four sides of the document.*

*The area to be erased indicates the area on each document page.*

## 8.6 Tiling copy images (“Image Repeat” function)

Multiple copies of the specified scanning area can be printed on a single sheet of paper.

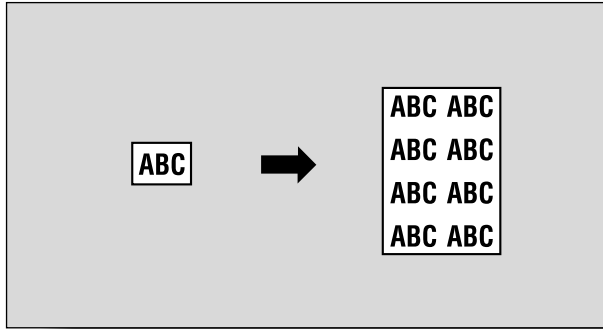

### To copy using the “Image Repeat” function

- 1 Position the document to be copied.
  - For details on positioning the document, refer to “Feeding the document” on page 3-8.
- 2 Load the paper to be used into the desired paper tray.
- 3 Touch [Application], and then touch [Book Copy/Repeat].

The Book Copy/Repeat screen appears.

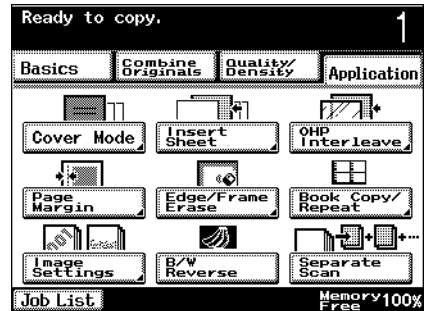

#### 4 Touch [Image Repeat].

- To cancel a Book Copy/Repeat function, touch [OFF].

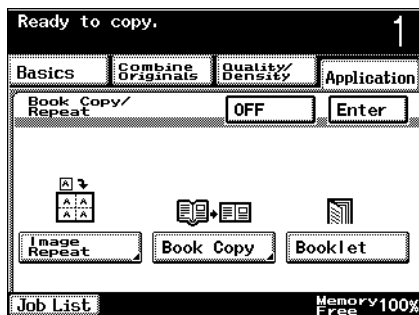

#### 5 Touch [Auto Detect] or [Oversized Paper], depending on the area of the document to be scanned.



- If "Auto Detect" is selected, the area of a standard document size is scanned. Continue with step 8.
- If "Oversized Paper" is selected, the size can be selected or a non-standard size can be entered. The Oversized Paper screen appears.
- To cancel the "Image Repeat" function, touch [OFF].

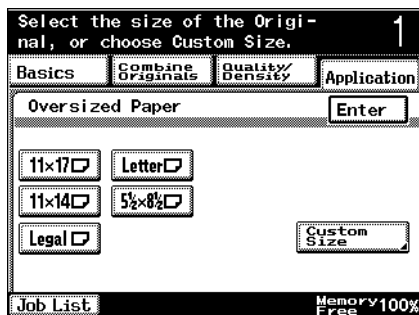

#### 6 Select the size of the area to be scanned.

- Touch [Custom Size] to display the Custom Size screen. Touch [X] or [Y], use the keypad to specify the size, and then touch [Enter].



- If “Inch (Fraction)” was selected as the measurement units, touch [X] or [Y] to position the cursor in the input box, and then touch  or  to specify the length.
- A value outside the allowable range cannot be entered.
- To change the entered value, press the [C] (clear) key, and then enter the correct value.
- If the “Image Repeat” function is registered with a program, both standard sizes and non-standard sizes can be registered. For details on registering programs, refer to “Registering copy programs (Mode Memory)” on page 4-8.

<Custom Size screen>

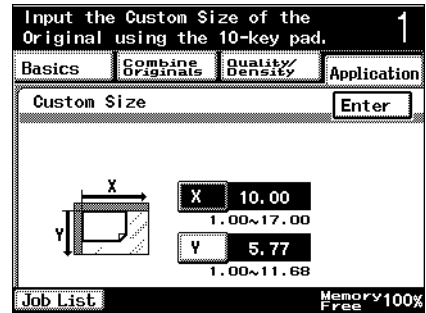

- 7 Touch [Enter].
- 8 Touch [Enter], and then touch [Enter] in the next two screens that appear.
- 9 In the Basics screen, touch [Paper], and then select the paper tray loaded with the paper.

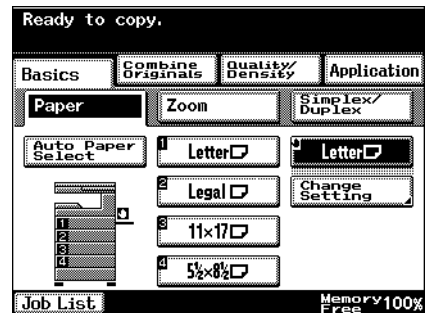

- 10 Specify any other desired copy settings.
- 11 Using the keypad, type in the desired number of copies.
- 12 Press the [Start] key.  
Copying begins.

## 8.7 Producing separate copies of each page in a page spread (“Book Copy” function)

A page spread, such as in an open book or catalog, can be copied with the left and right pages on separate pages or both on the same page.

In addition, settings can be specified for the “Page Order” and “Book Erase” functions. The following Book Copy settings are available.

Setting	Description
Separation	Separate copies of each page in the page spread is printed in the document page order. The document is scanned to fit the size of paper that will be used.
Book Spread	Both pages of the page spread are printed on the same page.

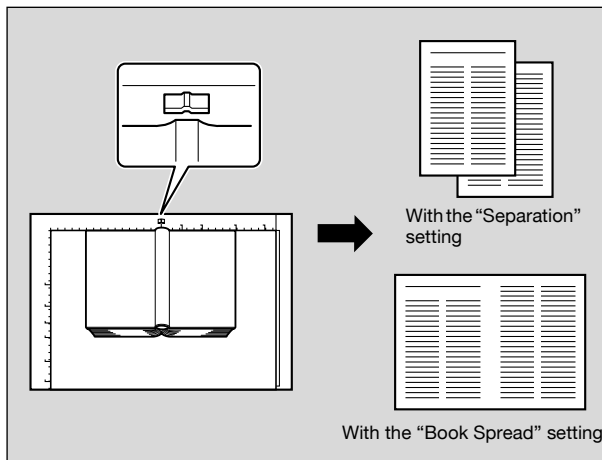

## To copy using the “Book Copy” function

- ✓ Place the document on the original glass.

- 1 Place the book on the original glass.
  - For details on positioning the document, refer to “Feeding the document” on page 3-8.
- 2 Load the paper to be used into the desired paper tray.

- 3 Touch [Application], and then touch [Book Copy/Repeat].

The Book Copy/Repeat screen appears.

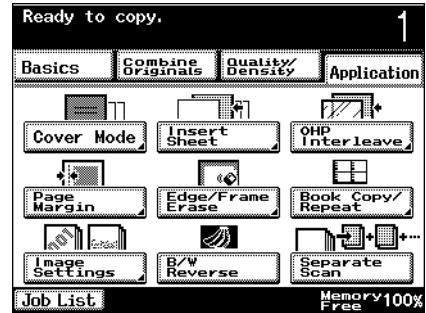

- 4 Touch [Book Copy].
  - To cancel a Book Copy/Repeat function, touch [OFF].

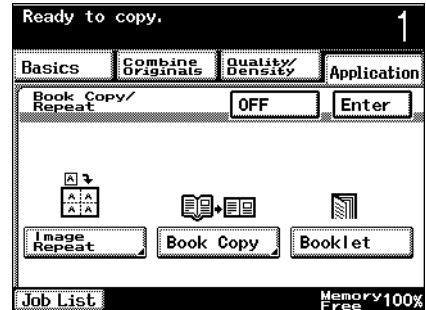

The Book Copy screen appears.

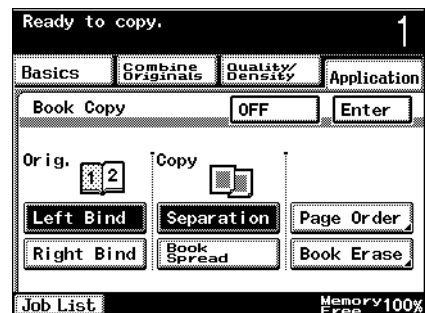

- 5 Touch [Left Bind] or [Right Bind], according to the binding position of the document.



## 6 Touch [Separation] or [Book Spread].

- When separating page spreads and making double-sided copies, touch [Page Order] to display the Page Order screen. Touch [Book Order] or [Standard], and then touch [Enter].
- To cancel the Page Order setting, touch [OFF].
- If "Page Order" is set to "Book Order", the left and right pages of the spread are copied onto two separate sheets of paper in the same page order as the document.
- If "Page Order" is set to "Standard", the left and right pages of the spread are copied onto the front and back sides of a single sheet of paper.
- If desired, touch [Book Erase] to display the Book Erase screen. Touch the buttons indicated by "Frame", specify the width of the erased area as  and , and then touch [Enter].

<Page Order screen>

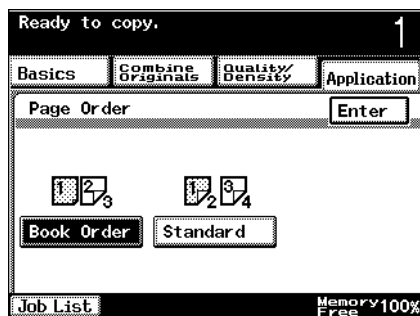

<Book Erase screen>

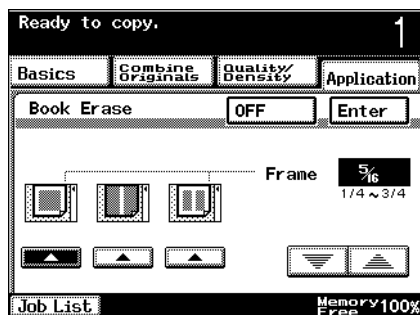

- ? What do the Book Erase settings do?
- If a Book Erase setting is selected, the dark shadows around the document or along the center of the document can be erased.

## 7 Touch [Enter], and then touch [Enter] in the next screen that appears.

- 8 In the Basics screen, touch [Paper], and then select the paper tray loaded with the paper.

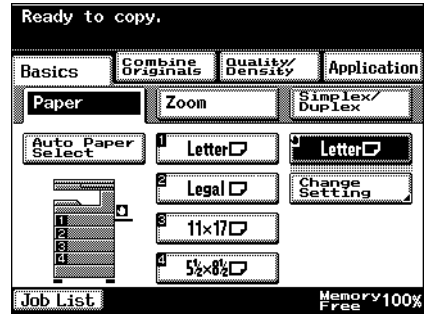

- 9 Specify any other desired copy settings.
- 10 Using the keypad, type in the desired number of copies.
- 11 Press the [Start] key.  
Copying begins.



**Note**

*For details on scanning a document with “Page Order” set to “Book Order”, refer to “Scanning a multi-page document from the original glass” on page 3-14.*



## 8.8 Creating booklet copies (“Booklet” function)

Double-sided copies of the document pages are arranged so that the copies can be read like a bound book when it is folded in half. Stapling is available only if optional finisher is installed.

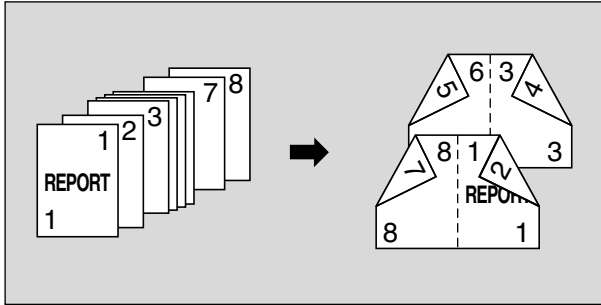

### Detail

*Generally, a multiple of 4 document pages is required with a single-sided document, and a multiple of 2 document pages is required with a double-sided document. If there are not enough pages, blank pages are automatically added at the end.*

*For details on stapling, refer to “Binding copies at the center” on page 3-59.*

*If the document contains more than 80 pages, refer to “Scanning a document in separate batches (“Separate Scan” setting)” on page 3-12.*

*The width of the binding margin is automatically specified.*

## To copy using the “Booklet” function

- 1 Position the document to be copied.
  - For details on positioning the document, refer to “Feeding the document” on page 3-8.

- 2 Touch [Application], and then touch [Book Copy/Repeat].

The Book Copy/Repeat screen appears.

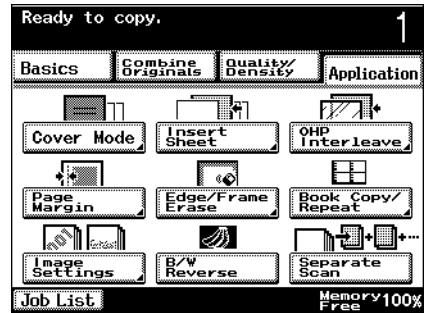

- 3 Touch [Booklet].
  - To cancel the “Booklet” function, touch [Booklet] again to deselect it.

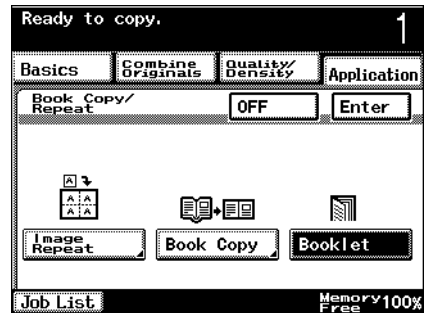

- 4 Specify any other desired copy settings.
- 5 Using the keypad, type in the desired number of copies.
- 6 Press the [Start] key.
 

Copying begins.

## 8.9 Printing additional information on copies (Image Settings functions)

A stamp, such as “CONFIDENTIAL” can be added to the center of background copies, or a distribution number can be added when multiple copies are made.

The following Image Settings functions are available.

Setting	Description
Set Numbering	A three-digit distribution number can be printed on each copy.
Stamp	The selected preset text (CONFIDENTIAL, TOP SECRET, COPY, DRAFT, DO NOT COPY, FINAL, or PROOF) can be printed.

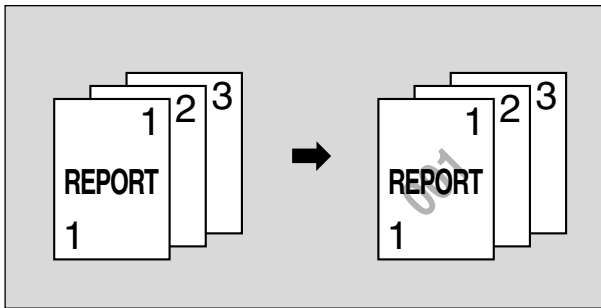

### To print the distribution number (“Set Numbering” function)

- ✓ The distribution number is normally printed as a three-digit number. If “Starting Number” is set to “1”, “001” is printed.

- 1 Position the document to be copied.
  - For details on positioning the document, refer to “Feeding the document” on page 3-8.

- 2 Touch [Application], and then touch [Image Settings].

The Image Settings screen appears.

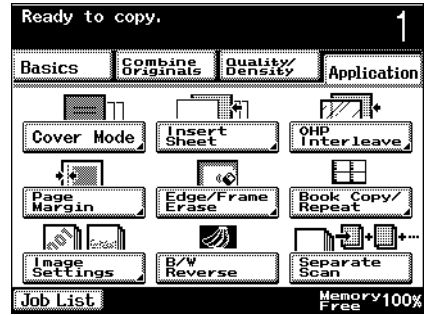

- 3 Touch [Set Numbering].
- To cancel the Image Settings functions, touch [OFF].
  - If the optional hard disk drive is installed, the “Image Overlay” function can be used. For details, refer to “Printing copies overlapping a different image (“Image Overlay” function)” on page 8-28.

The Set Numbering screen appears.

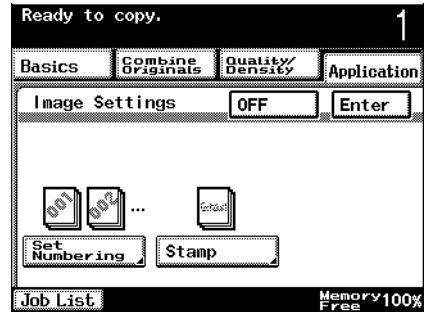

- 4 Using the keypad, type in the starting number under “Starting Number”.
- The starting number can be set between 0 and 999.
  - Press the [C] (clear) key to reset “Starting Number” to “1”.
  - To cancel the “Set Numbering” function, touch [OFF].

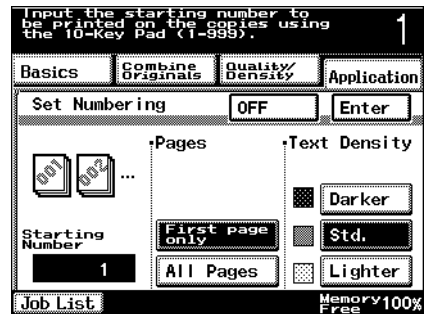

- 5 Select the desired settings under “Pages” and “Text Density”.
  - If “Pages” is set to “First page only”, the distribution number is only printed on the first page of the copy. If “All Pages” is selected, the distribution number is printed on all pages.
  - Select a setting under “Text Density” to specify the density of the printed distribution number.
- 6 Touch [Enter], and then touch [Enter] in the next screen that appears.
- 7 Specify any other desired copy settings.
- 8 Using the keypad, type in the desired number of copies.
- 9 Press the [Start] key.  
Copying begins.

### To print preset text at the center of the copy image (“Stamp” function)

- 1 Position the document to be copied.
  - For details on positioning the document, refer to “Feeding the document” on page 3-8.
- 2 Touch [Application], and then touch [Image Settings].

The Image Settings screen appears.

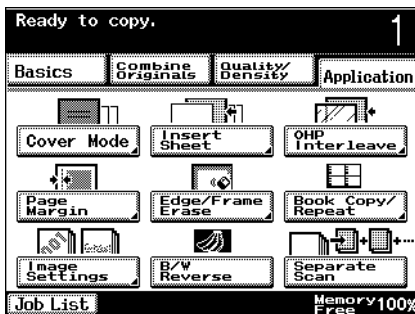

- 3 Touch [Stamp].
- To cancel the Image Settings functions, touch [OFF].

The Stamp screen appears.

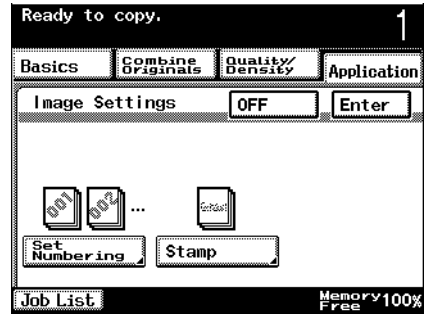

- 4 Select the desired stamp pattern and the desired setting under “Pages”.

- If “Pages” is set to “First page only”, the stamp is only printed on the first page of the copy. If “All Pages” is selected, the stamp is printed on all pages.
- To cancel the “Stamp” function, touch [OFF].

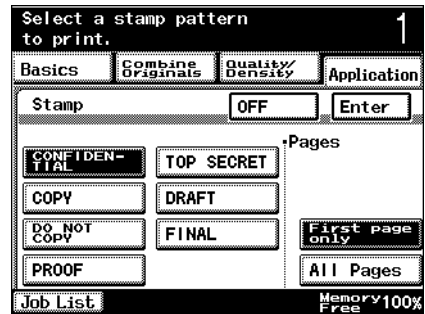

- 5 Touch [Enter], and then touch [Enter] in the next screen that appears.
- 6 Specify any other desired copy settings.
- 7 Using the keypad, type in the desired number of copies.
- 8 Press the [Start] key.  
Copying begins.

## 8.10 Printing copies overlapping a different image (“Image Overlay” function)

Images previously stored on the hard disk can be printed overlapping copies.

### To store an overlay image (Store Overlay)

- ✓ The “Store Overlay” function is available only if optional hard disk is installed.

- 1 Position the overlay document to be stored on the hard disk.
  - For details on positioning the document, refer to “Feeding the document” on page 3-8.

- 2 Press the [Utility/Counter] key, and then touch [User Setting].

The User Setting screen appears.

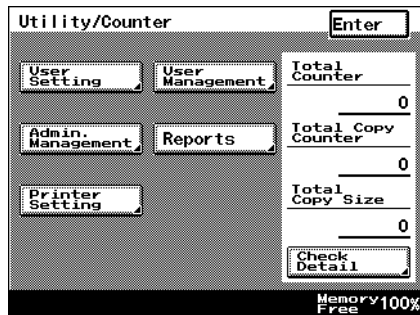

- 3 Touch [Store Overlay].

The Store Overlay screen appears.

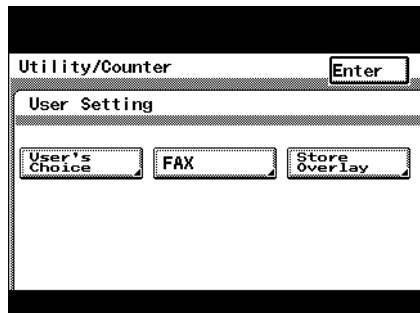

- 4 Touch [Set], and then touch the button ([1] through [5]) for the number where the image is to be stored.

- If a button is pressed where no image is stored, the size of the stored image appears on the button to indicate that an image has been stored.

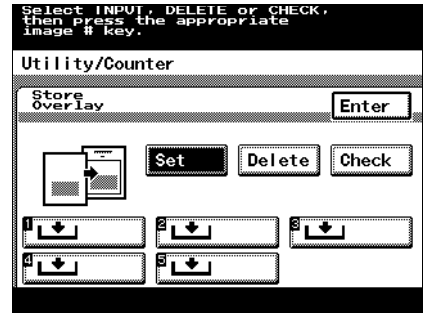

No program registered

Program registered



- To store the image with a number where an image is already stored, delete the image, touch [Set], and then touch the button for the number.
- To delete the image, touch [Delete], and then touch the button for the number stored with the image.

- 5 Select the size of the area to be scanned.

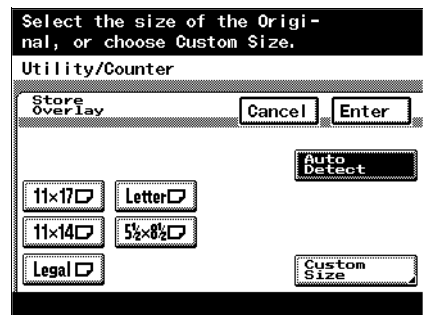

- To cancel changes to the settings, touch [Cancel].
- Touch [Auto Detect] to automatically detect the size of the area to be scanned in the document image.





- Touch [Custom Size] to display the Custom Size screen.

Touch [X] or [Y], use the keypad to specify the size, and then touch [Enter].

- If "Inch (Fraction)" was selected as the measurement units, touch [X] or [Y] to position the cursor in the input box, and then touch  or  to specify the length.
- A value outside the allowable range cannot be entered.
- To change the entered value, press the [C] (clear) key, and then enter the correct value.

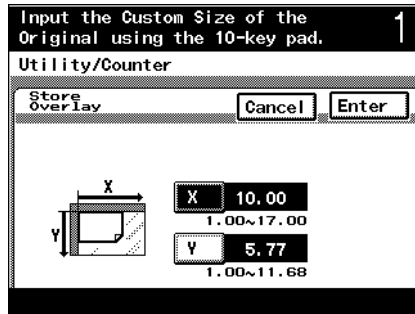

6 Touch [Enter].

7 Select the document orientation.

- To cancel changes to the settings, touch [Cancel].

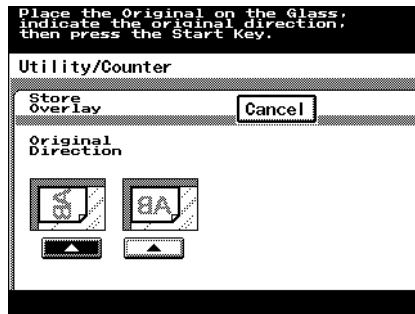

8 Press the [Start] key.

The document is scanned, and the overlay image is stored.



#### Note

*The size of the scanned area appears on the button where the image is stored.*

## To recall an overlay image

Stored overlay images can be recalled and printed overlapping copies.

- ✓ The “Image Overlay” function is available only if optional hard disk is installed.

- 1 Position the document to be copied.
  - For details on positioning the document, refer to “Feeding the document” on page 3-8.

- 2 Touch [Application], and then touch [Image Settings].

The Image Settings screen appears.

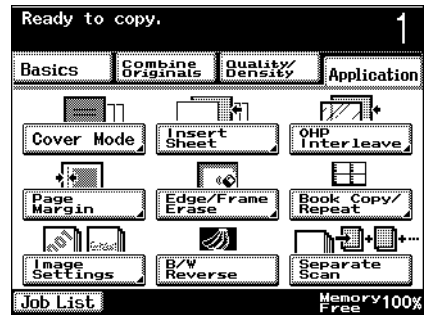

- 3 Touch [Image Overlay].

- To cancel the Image Settings functions, touch [OFF].

The Image Overlay screen appears.

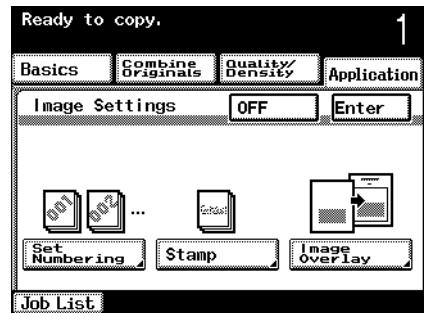

- 4 Touch [Recall], and then touch the button for the number stored with the image.

- To cancel the “Image Overlay” function, touch [OFF].

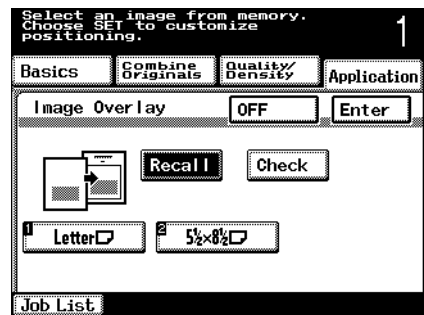

5 Specify the printing position.

- Touch the button for positioning the overlay at the top, center or bottom.

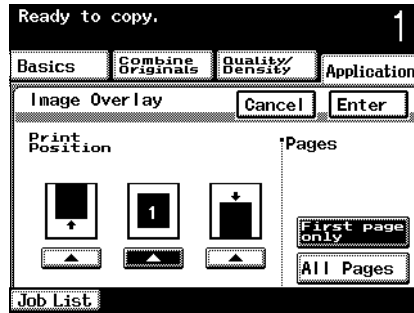

6 Select the desired setting under “Pages”.

- If “Pages” is set to “First page only”, the overlay image is only printed overlapping the first page of the copy. If “All Pages” is selected, the overlay image is printed overlapping all pages.
- To cancel changes to the settings, touch [Cancel].

7 Touch [Enter], and then touch [Enter] in the next two screens that appear.

8 Specify any other desired copy settings.

9 Using the keypad, type in the desired number of copies.

10 Press the [Start] key.

Copying begins.



**Note**

*The size of the scanned area appears on buttons where an image is stored.*

## To check the overlay image

The stored image can be printed from the Image Overlay screen or Store Overlay screen in order to be checked.

The following procedure describes how to check the image from the Image Overlay screen of the Application screen.

- ✓ The “Image Overlay” function is available only if optional hard disk is installed.

- 1 Touch [Application], and then touch [Image Settings].

- To check the image from the Store Overlay screen, display the Store Overlay screen, and then perform the same procedure starting from step 3. For details on displaying the Store Overlay screen, refer to “To store an overlay image (Store Overlay)” on page 8-28.

The Image Settings screen appears.

- 2 Touch [Image Overlay].

- To cancel the Image Settings functions, touch [OFF].

The Image Overlay screen appears.

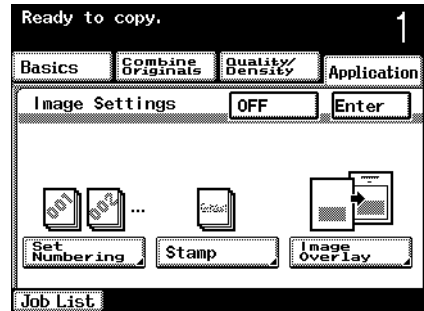
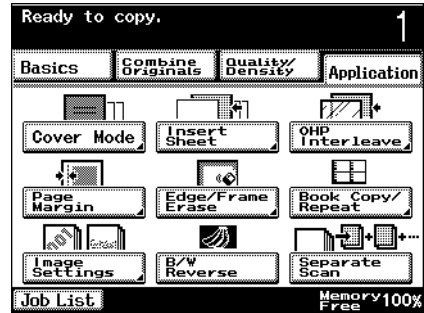

- 3 Touch [Check], and then touch the button for the number stored with the image.

- To cancel the “Image Overlay” function, touch [OFF].

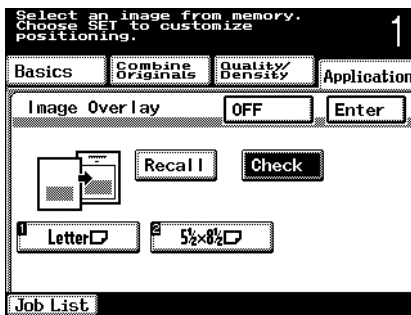

- 4 Select a paper tray loaded with paper.

- To cancel changes to the settings, touch [Cancel].

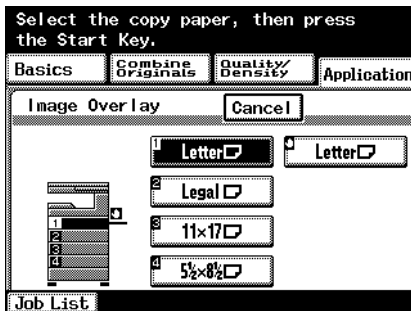

- 5 Press the [Start] key.

The overlay image is printed.



**Note**

*The size of the scanned area appears on buttons where an image is stored.*

## 8.11 Copying with light and dark coloring inversed (“B/W Reverse” setting)

A document can be copied with the light and dark coloring or the black and white coloring (gradations) of the image inversed.

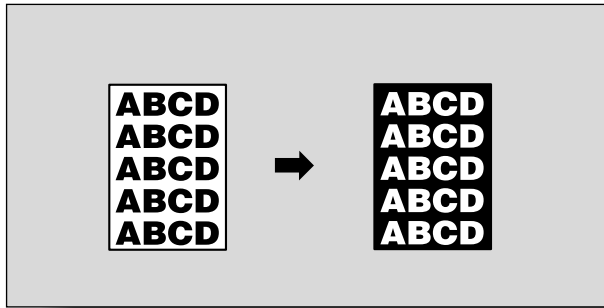

### To copy using the “B/W Reverse” setting

- 1 Position the document to be copied.
  - For details on positioning the document, refer to “Feeding the document” on page 3-8.
- 2 Touch [Application], and then touch [B/W Reverse].
  - To cancel the “B/W Reverse” setting, touch [B/W Reverse] again to deselect it.

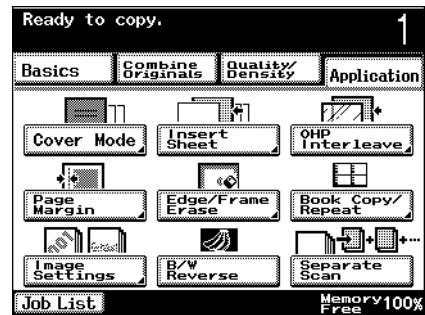

- 3 Specify any other desired copy settings.
- 4 Using the keypad, type in the desired number of copies.
- 5 Press the [Start] key.
 

Copying begins.

## 8.12 Separate scan

The machine can be set to continue scanning the document.

### To scan documents continuously

- Touch [Application], and then touch [Separate Scan].
- To cancel the “Separate Scan” setting, touch [Separate Scan] again to deselect it.

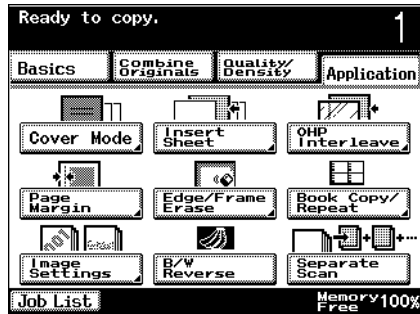

#### Detail

For details on continuously scanning documents, refer to “Scanning a document in separate batches (“Separate Scan” setting)” on page 3-12.

---

A large, bold, black number '9' is centered within a light gray rectangular background.

## **Replacing toner bottles and staples and emptying punch waste containers**



## 9 Replacing toner bottles and staples and emptying punch waste containers

### 9.1 Replacing the toner bottle

When the toner is about to run out, the advanced warning message shown below appears.



#### Detail

First, the message "Please exchange toner." appears, and then the message "There is no Toner." appears and the machine stops operating. The number of pages that can be printed after the message "Please exchange toner." appears and before the message "There is no Toner." appears differs depending on the printing conditions, the consumables and the part to be replaced. After the first message appears, prepare to replace the toner bottle according to your maintenance agreement.

When the toner is empty, the warning message shown below appears and copies can no longer be made.

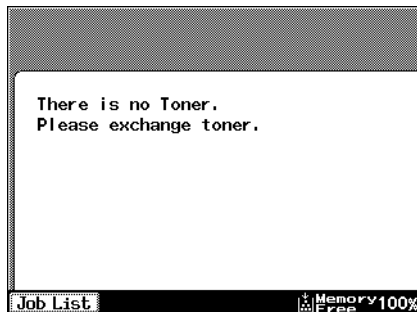

**Note**

*When the message appears, replace the toner bottle according to your maintenance agreement.*

**Detail**

*For details on replacing the toner bottle, refer to “To replace the toner bottle” on page 9-4.*

**CAUTION****Handling toner and toner bottles**

- Do not throw toner or the toner bottle into a fire.
- Toner expelled from the fire may cause burns.

**CAUTION****Precautions for toner spills**

- Be careful not to spill toner inside the machine or get toner on your clothes or hands.
- If your hands become soiled with toner, immediately wash them with soap and water.
- If toner gets in your eyes, immediately flush them with water, and then seek professional medical attention.

**Reminder**

*Be sure to replace the toner bottle only after the message “There is no Toner.” appears.*

*Be sure to use toner bottles of the specified model, otherwise the machine may be damaged.*

**To replace the toner bottle**

- 1 Open the machine's front door.
- 2 Pull the toner hopper out toward you as far as possible.

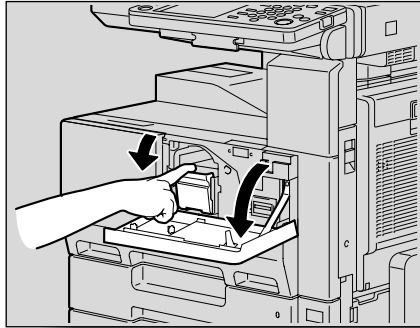

- 3 While pulling on the handle, flip up the toner bottle holder.

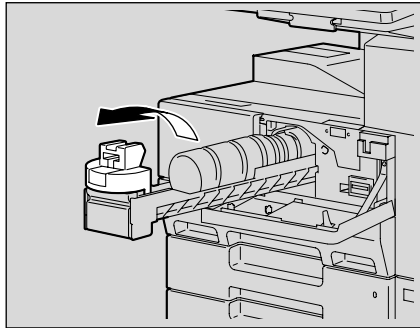

- 4 Carefully pull out the used toner bottle.

? How is the used toner bottle disposed of?

→ Do not throw away the empty toner bottle. Instead, keep it so that it can be collected by your technical representative.

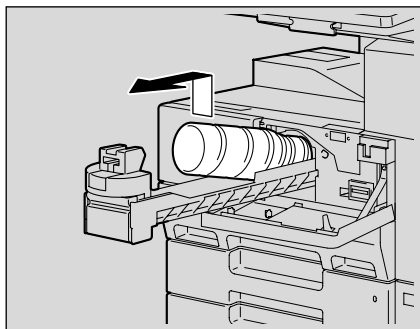

- 5 Hit one end of the new toner bottle against a hard surface, such as a desk or table, four or five times, and then hit the other end four or five times.

- The toner within the toner bottle may have become compacted. If it has, be sure to shake the toner bottle until the toner is mostly broken up before installing the bottle.

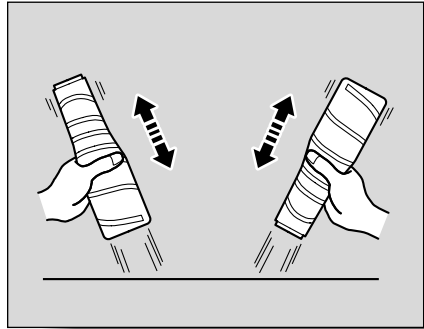

- 6 Shake the new toner bottle up and down about five times.

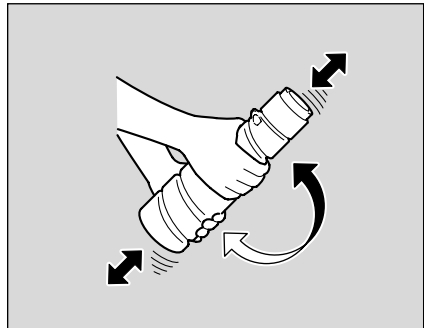

- 7 Insert the toner bottle into the toner hopper with the label on the bottle facing up.

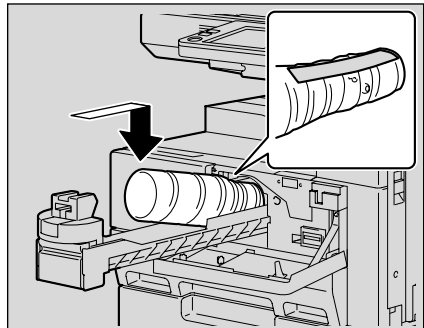

- 8 Flip down the toner bottle holder so that it locks into place. Grab the seal on the toner bottle, and then slowly pull it off toward you.

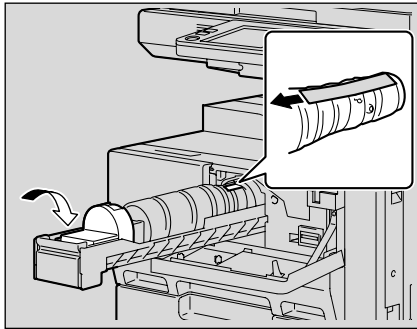

- 9 Insert the toner hopper until it snaps into place.

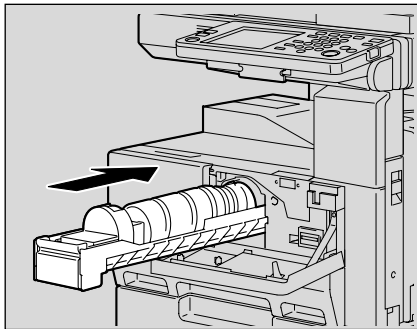

- 10 Close the front door.



#### Reminder

*When the front door is closed, toner replenishing begins automatically. While the toner is being replenished, do not turn the machine off or open any door of the machine.*



#### Detail

*If the print is faint immediately after the toner bottle is replaced, replenish the toner. For details on replenishing toner, refer to "Toner Supply" on page 11-20.*

## 9.2 Replacing the staple cartridge

When the staple cartridge runs out of staples, the message shown below appears.

Example: Message when the finisher has run out of staples

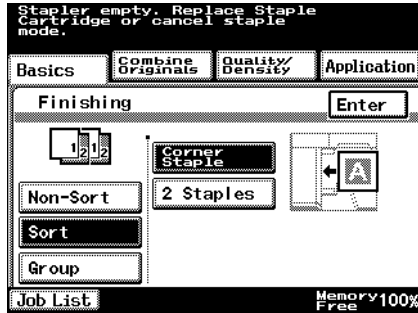

### Detail

*Be sure to replace the staple cartridge only after the message appears, otherwise the machine may be damaged.*

### To replace the staple cartridge in finisher

- 1 Open the front door.

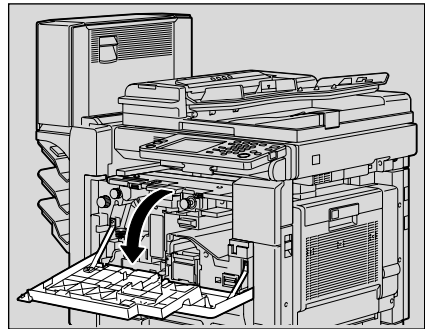

- 2 Push up the staple cartridge holder, and then remove it toward you.

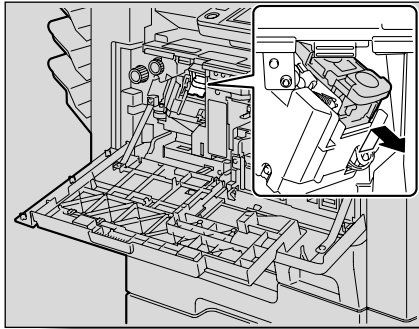

- 3 Press in the area marked "PUSH" to unlock the staple cartridge holder.

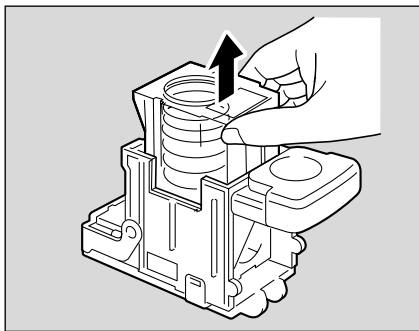
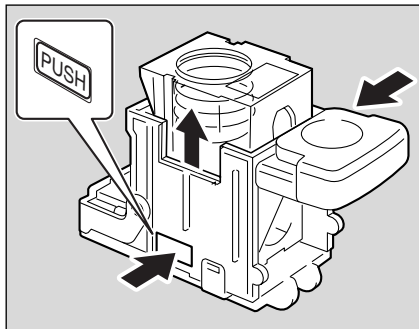

- 4 Remove the empty staple cartridge from the staple cartridge holder.

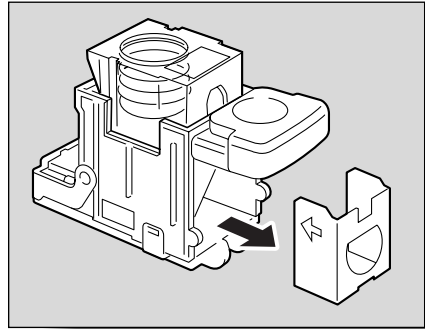

- 5 Insert the new staple cartridge into the staple cartridge holder.

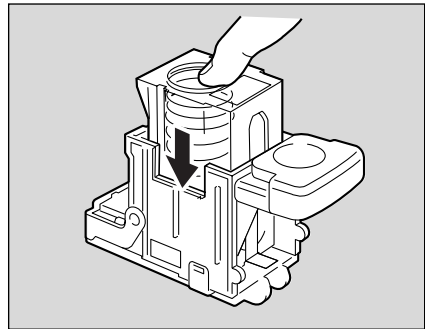
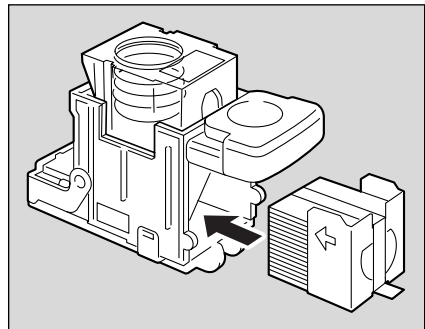



- 6** Carefully remove the stopper.

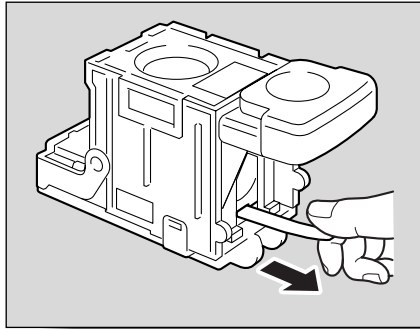

- 7** Insert the staple cartridge holder, and then push it down until it locks into place.

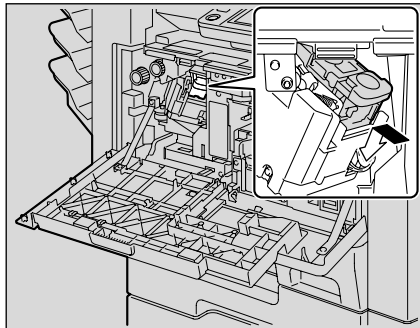

- 8** Close the front door.

### To replace the staple cartridge in saddle sticher

- 1** Raise the copy output tray, and then push down the staple cartridge holder and remove it.

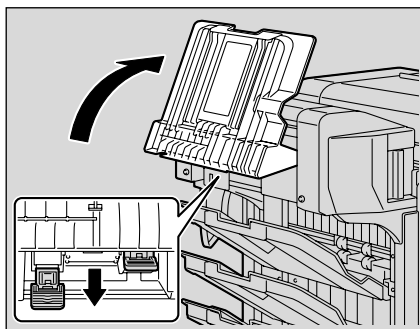

- 2 Press in the area marked "PUSH" to unlock the staple cartridge holder.

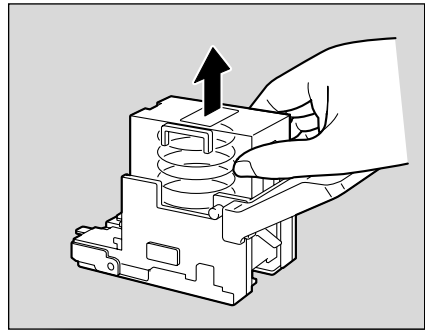
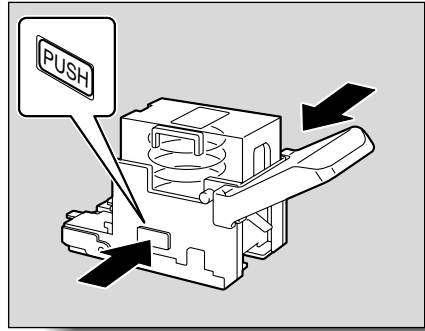

- 3 Remove the empty staple cartridge from the staple cartridge holder.

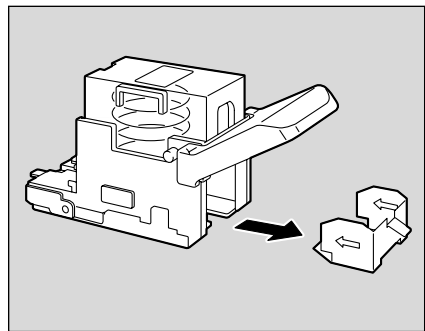

- 4 Load the new staple cartridge into the staple cartridge holder.

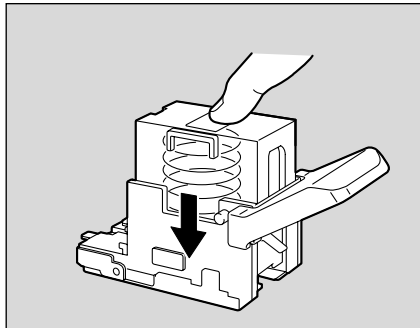
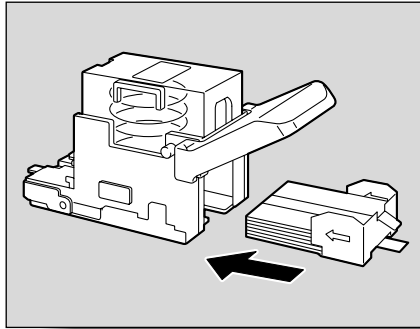

- 5 Carefully remove the stopper.

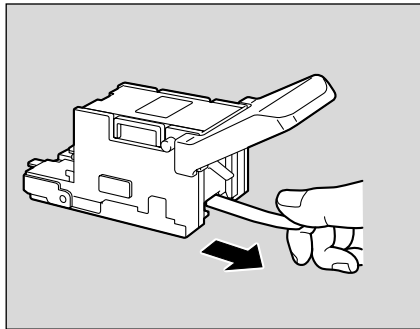

- 6 Insert the staple cartridge holder, and then push it up until it locks into place.
- When inserting the staple cartridge holder, be sure to insert it so that it faces the correct direction.

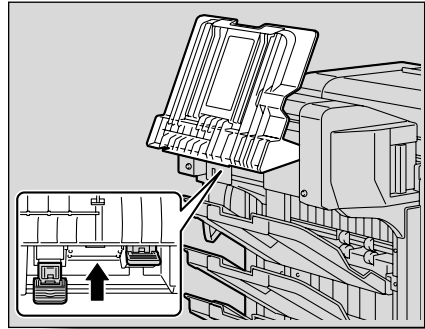

- 7 Return the copy output tray to its original position.
- 8 Pull the handle of the misfeed-clearing door to open it, and then close it.

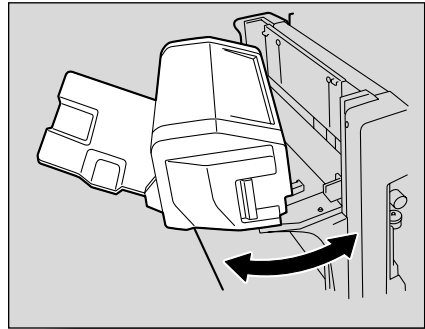

## 9.3 Clearing a staple jam

If a staple jam occurs, the message shown below appears.



For a staple jam in the saddle stitcher:

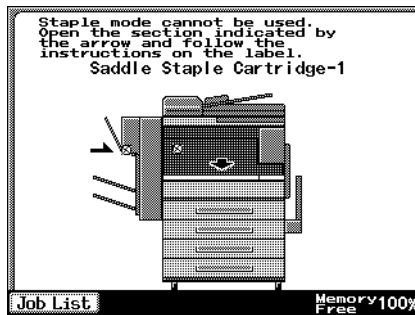

### Reminder

*Be careful when clearing jammed staples since injuries may result.*

*Follow the procedure described below to clear jammed staples. If the paper is pulled out with too much force, the stapler unit may be damaged.*

**To clear jammed staples in finisher**

- 1 Remove all paper from the finisher.

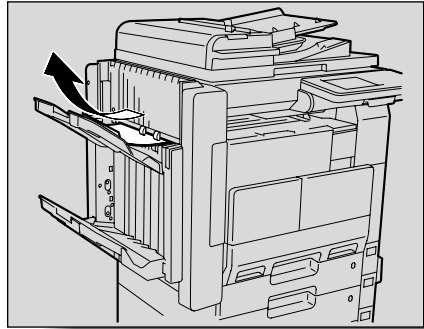

- 2 Open the front door.

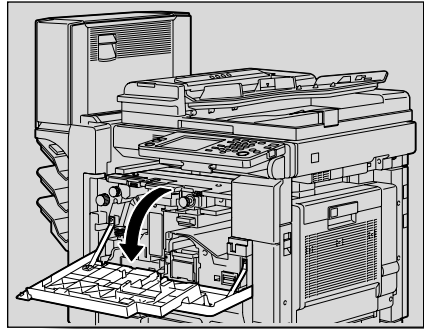

- 3 Lower lever FN1, and then remove any paper.

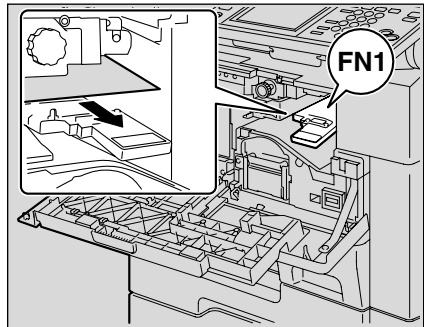

- 4 Turn dial FN2.

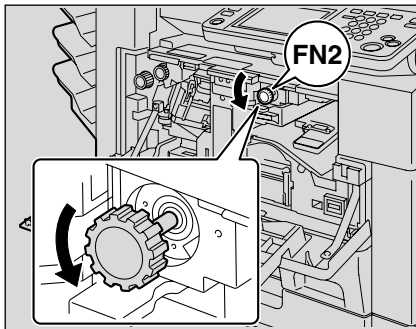

- If the punch unit is installed, pull out the hole-punch waste container.

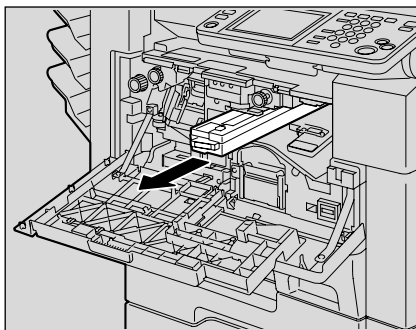

- 5 Lower lever FN3, and then remove any paper.

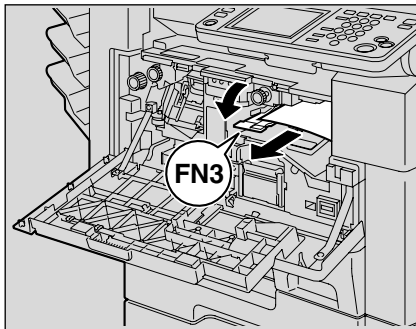

- 6 Return levers FN1 and FN3 to their original positions.

- If the punch unit is installed, insert the hole-punch waste container into its original position.

7 Lower lever FN4.

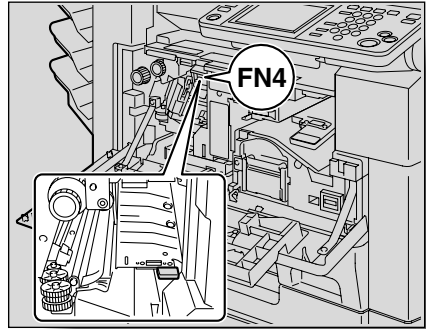

8 Turn dial FN5 or dial FN6, and then pull out any paper.

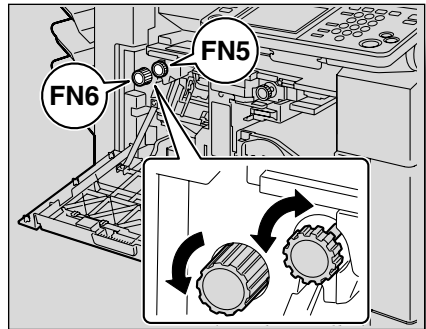

9 Return lever FN4 to its original position.

10 Turn the dial to the left to move the stapler toward the front.

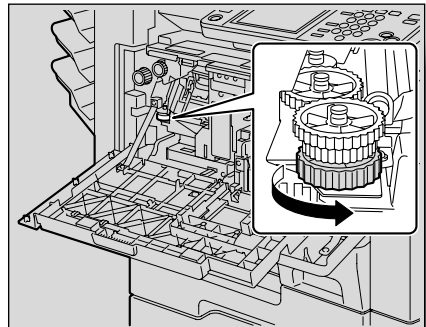



- 11** Push up the staple cartridge holder, and then remove it toward you.

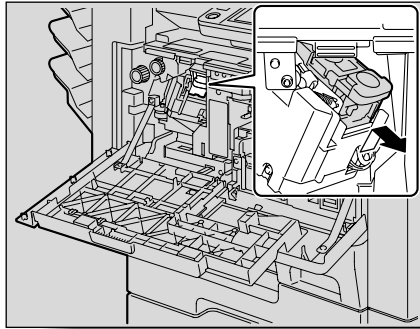

- 12** Raise the shutter of the staple cartridge holder, and then pull out one sheet of staples.

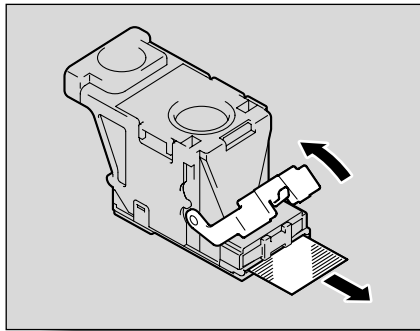

- 13** Return the shutter to its original position.

- 14** Insert the staple cartridge holder until it locks into place.

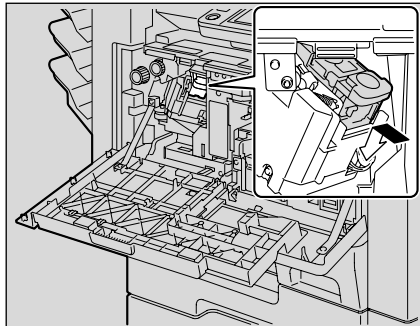

- 15 Close the front door.

**Reminder**

*If stapling still cannot be resumed, even after performing the above procedure, contact your technical representative.*

**To clear jammed staples in the saddle sticher**

- 1 Open the front door.

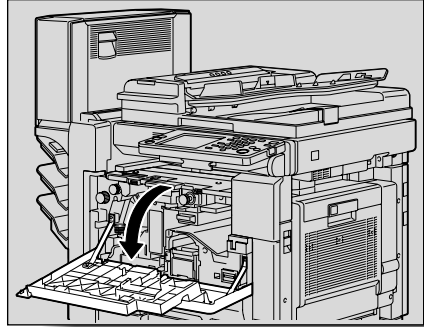

- 2 Lower lever FN1, and then remove any paper.

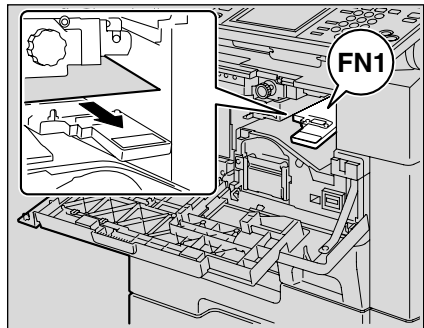

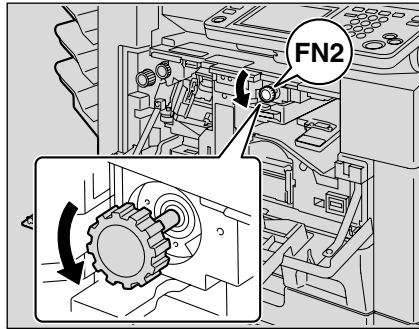
**3** Turn dial FN2.

- If the punch unit is installed, pull out the hole-punch waste container.

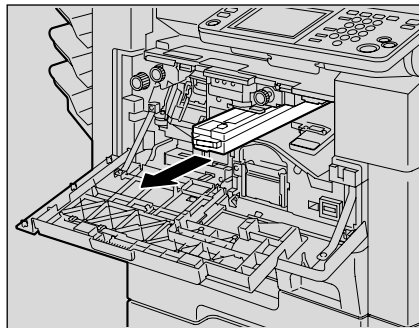
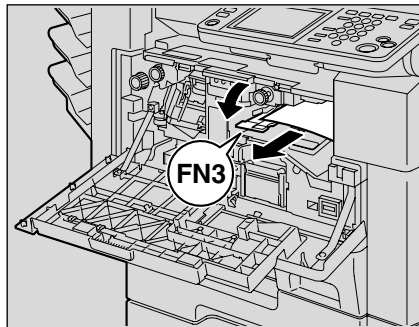
**4** Lower lever FN3, and then remove any paper.**5** Return levers FN1 and FN3 to their original positions.

- If the punch unit is installed, insert the hole-punch waste container into its original position.

6 Lower lever FN4.

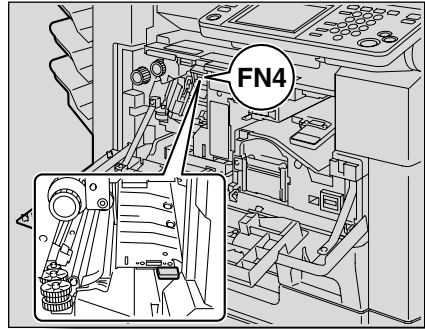

7 Turn dial FN5 or dial FN6, and then pull out any paper.

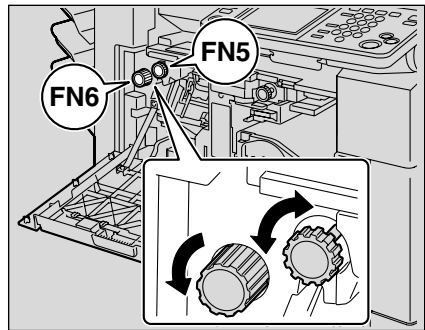

8 Return lever FN4 to its original position.

9 Open the misfeed-clearing door, and then pull out any misfed paper.

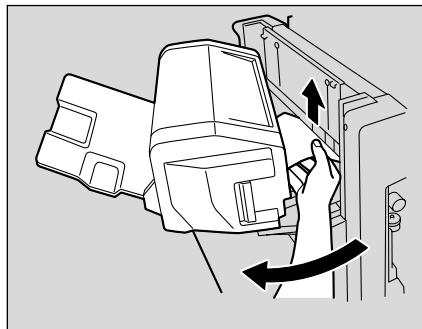

- 10** Raise the copy output tray, and then push down the staple cartridge holder and remove it.

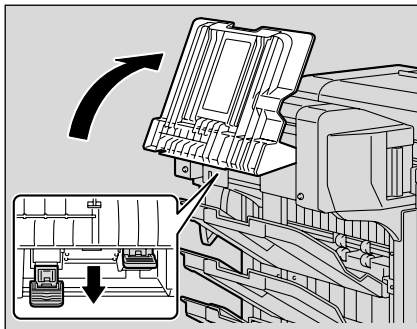

- 11** Raise the shutter of the staple cartridge holder, and then pull out one sheet of staples.

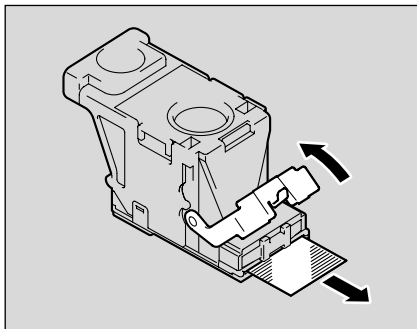

- 12** Return the shutter to its original position.

- 13** Insert the staple cartridge holder, and then push it up until it locks into place.
- When inserting the staple cartridge holder, be sure to insert it so that it faces the correct direction.

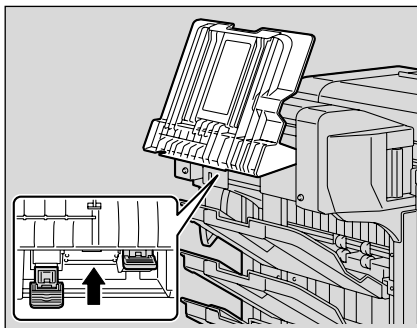

- 14 Return the copy output tray to its original position.
- 15 Close the misfeed-clearing door.
- 16 Close the front door.

**Reminder**

*If stapling still cannot be resumed, even after performing the above procedure, contact your technical representative.*

## 9.4 Emptying the waste containers

If the hole-punch waste container in punch unit installed on finisher becomes full, the message shown below appears.

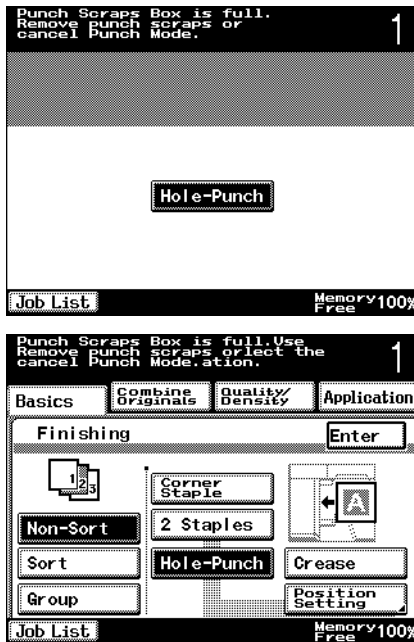

### To empty the hole-punch waste container

Follow the procedure described below to empty the hole-punch waste container.

- 1 Open the front door.

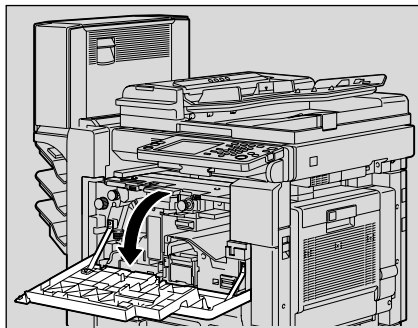

- 2 Pull out the hole-punch waste container.

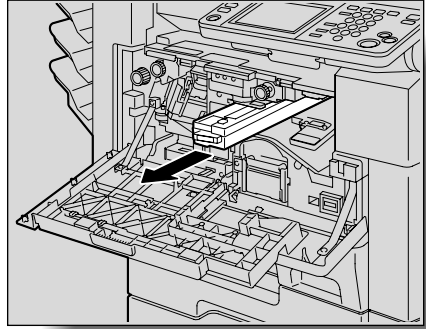

- 3 Empty the hole-punch waste container.

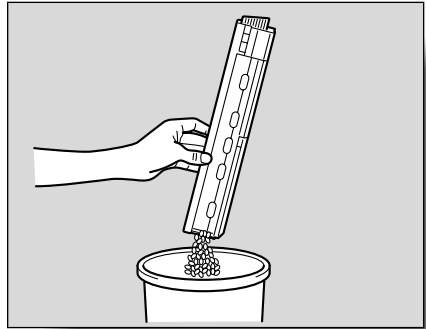

- 4 Insert the hole-punch waste container at its original position.
- 5 Close the front door.





---

# 10

## Care of the machine

## 10 Care of the machine

### 10.1 Cleaning

This section describes the procedures for cleaning each part.

#### Housing

- Clean the surface of the housing by wiping it with a soft cloth dampened with a mild household detergent.

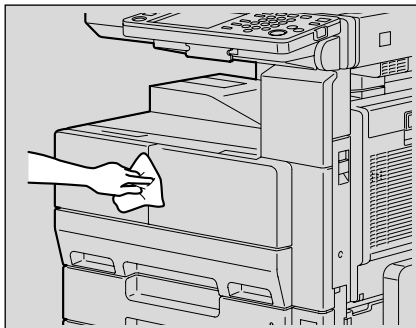

#### Reminder

*Be sure to turn off the machine (set the main power switch to "O") before cleaning it.*

*Never use solvents, such as benzene or thinner, to clean the housing.*

**Original glass**

- Clean the surface of the original glass by wiping it with a soft, dry cloth.

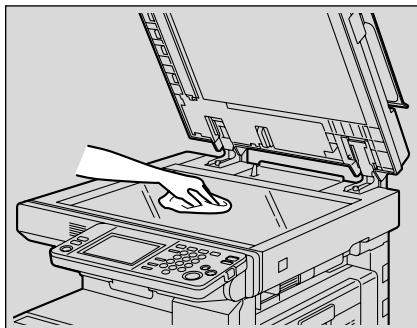
**Reminder**

*Never use solvents, such as benzene or thinner, to clean the original glass.*

### Control panel

- Clean the control panel by wiping it with a soft, dry cloth.

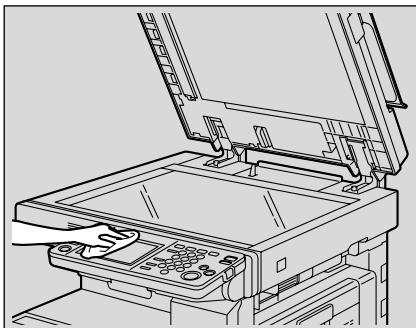

#### Reminder

*Pressing too hard on a key in the control panel or on the touch panel may damage them. In addition, never use a mild household detergent, glass cleaner, benzene or thinner to clean the control panel or touch panel.*



#### Detail

*When cleaning the control panel, displaying the Panel cleaning screen may prevent incorrect operations from being performed. For details, refer to "Panel Cleaning" on page 11-20.*

**Document pad**

- Clean the document pad by wiping it with a soft cloth dampened with a mild household detergent.

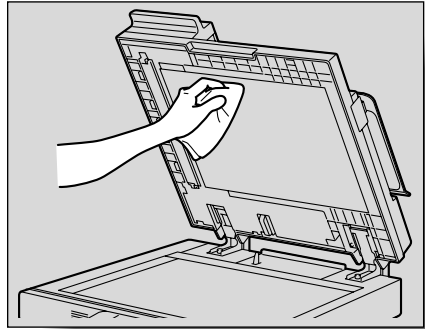
**Left partition glass**

Clean the Left partition glass when the optional ADF is installed.

- Clean the Left partition glass by wiping it with a soft, dry cloth.

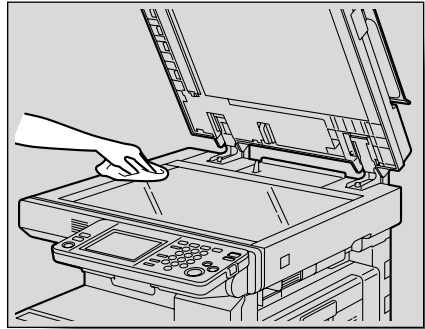
**Reminder**

*Never use solvents, such as benzene or thinner, to clean the Left partition glass.*

## 10.2 Viewing counters (Total Counter)

The Total Counter screen can be displayed so that the total number of prints since counting started can be viewed.

### To view the contents

- 1 Press the [Utility/Counter] key.
- 2 Touch [Check Detail].

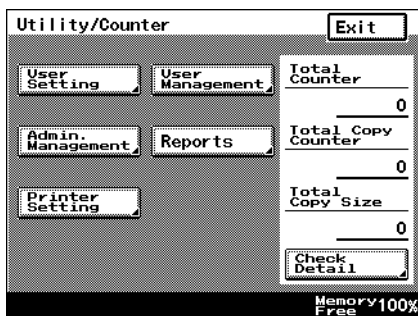

The Counter screen appears.

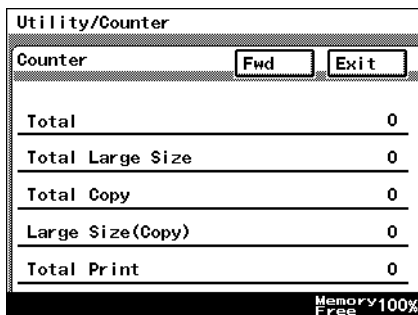

- 3 Touch [Exit], and then touch [Enter] in the next screen that appears.  
The Basic screen appears again.



### Note

*In the Counter screen, touch [Fwd] to display the next screen, or touch [Back] to display the previous screen.*

### 10.3 When the message “Preventative Maintenance is required.” appears

If the message “Preventative Maintenance is required.” appears, contact your service representative and request a periodic maintenance inspection.

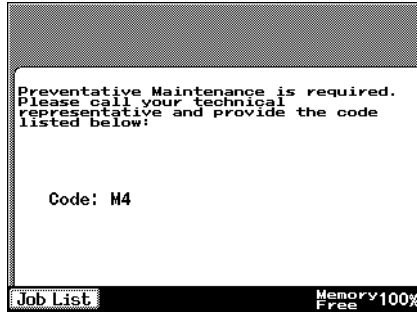





---

# 11

## Utility mode

# 11 Utility mode

## 11.1 Overview of Utility mode parameters

### List of registration information and parameters

This section describes the buttons available when the [Utility/Counter] key is pressed.



#### Note

*The buttons that appear in the screens differ depending on the specified settings.*

*Buttons marked with<sup>\*1</sup> may not appear depending on the specified settings or whether specific options are installed. For details, refer to the corresponding page for the button.*

*The names of buttons marked with<sup>\*2</sup> may be different when fax kit is installed.*

*For details on the buttons marked with<sup>\*3</sup>, refer to the User's Guide [Facsimile Operations].*

*For details on buttons marked with<sup>\*4</sup>, refer to the User's Guide [Network Scanner Operations].*

*For details on buttons marked with<sup>\*5</sup>, refer to the User's Guide [Print Operations].*

*For details on the buttons marked with<sup>\*6</sup>, refer to the User's Guide [Box Operations].*

*If user authentication settings have been specified and the [Utility/Counter] key is pressed without performing user authentication, only the buttons marked with<sup>\*7</sup> appear.*

Utility/Counter			
User Setting	User's Choice (p. 11-9)	1/6	Mixed Original Detection Language Selection Measurement Unit Setting Machine Authentication PW Change
		2/6	Default Setting Simplex / Duplex Auto Paper / Auto Zoom Priority Tray Special Paper Setting Zoom Ratio for Combine Booklets
		3/6	Low Power Mode Sleep Mode LCD Backlight OFF Auto Reset Auto Reset when Account is changed
		4/6	4in1 Copy Order Default Quality / Density Modes Default Copy Density Levels Print Density Default Finishing Mode
		5/6	Sort / Non-Sort Auto Change Output Tray Settings <sup>*1</sup> Auto Paper Select for Small Original Crease / Center Staple <sup>*1</sup>
		6/6	Default Screen

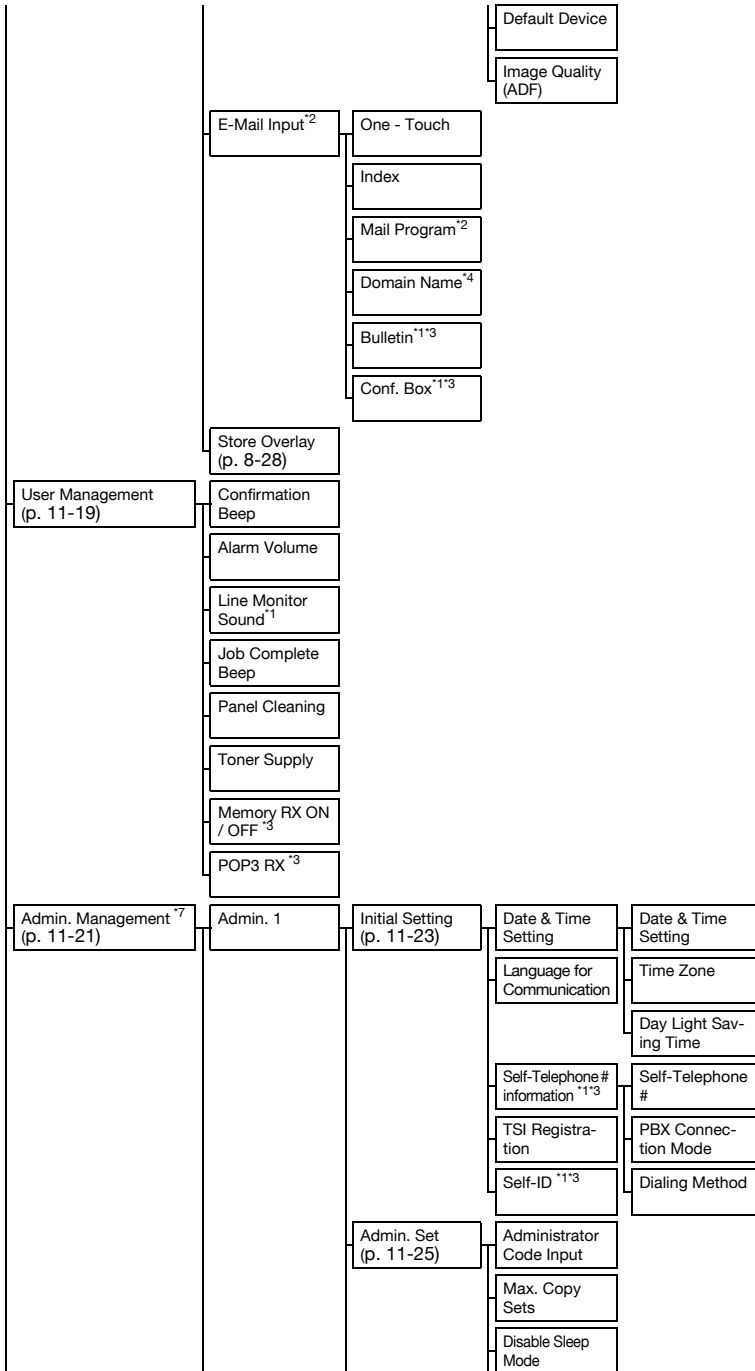

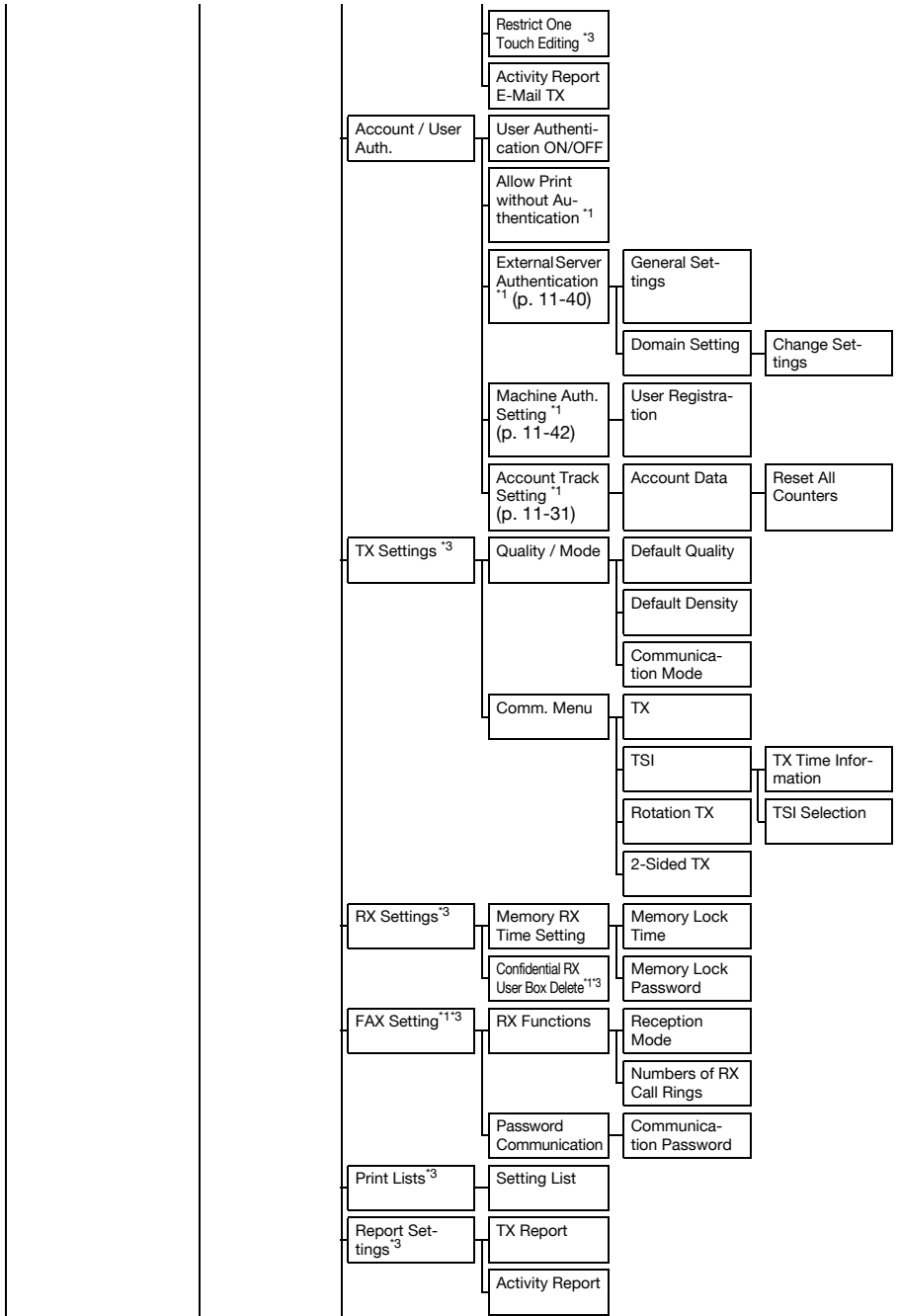

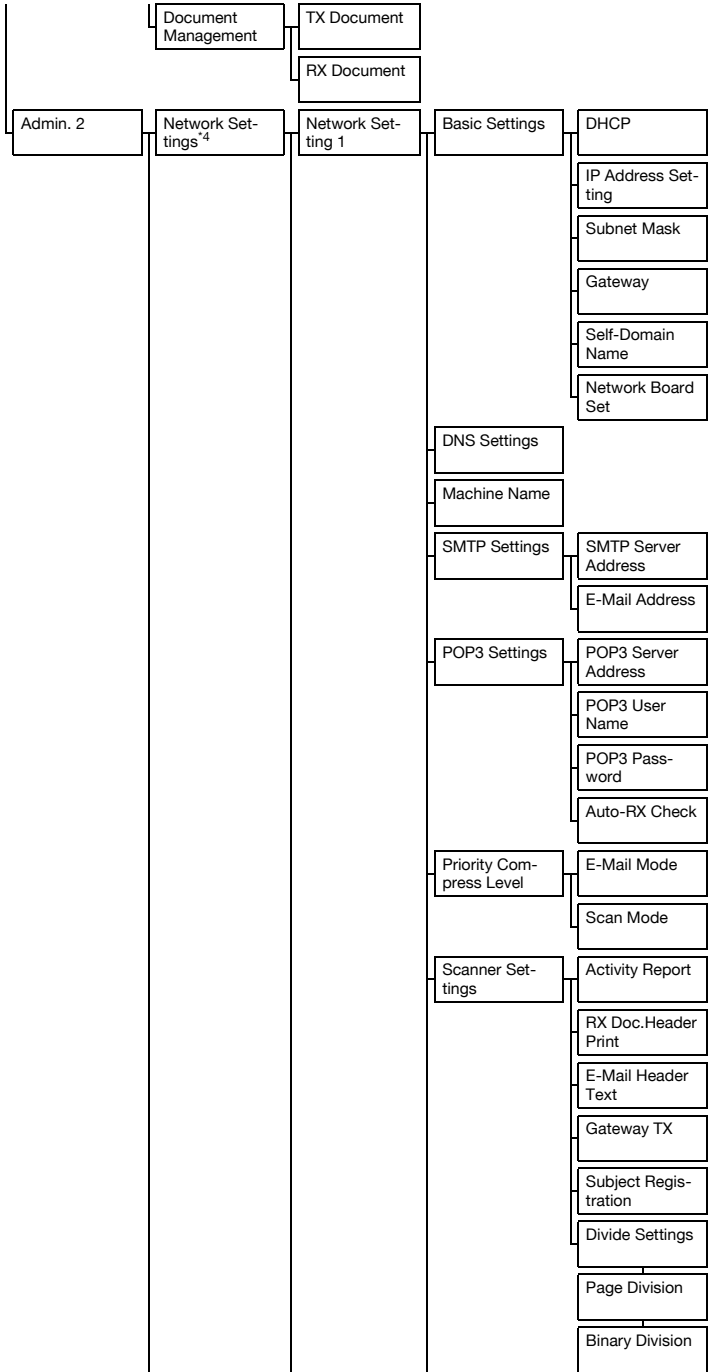

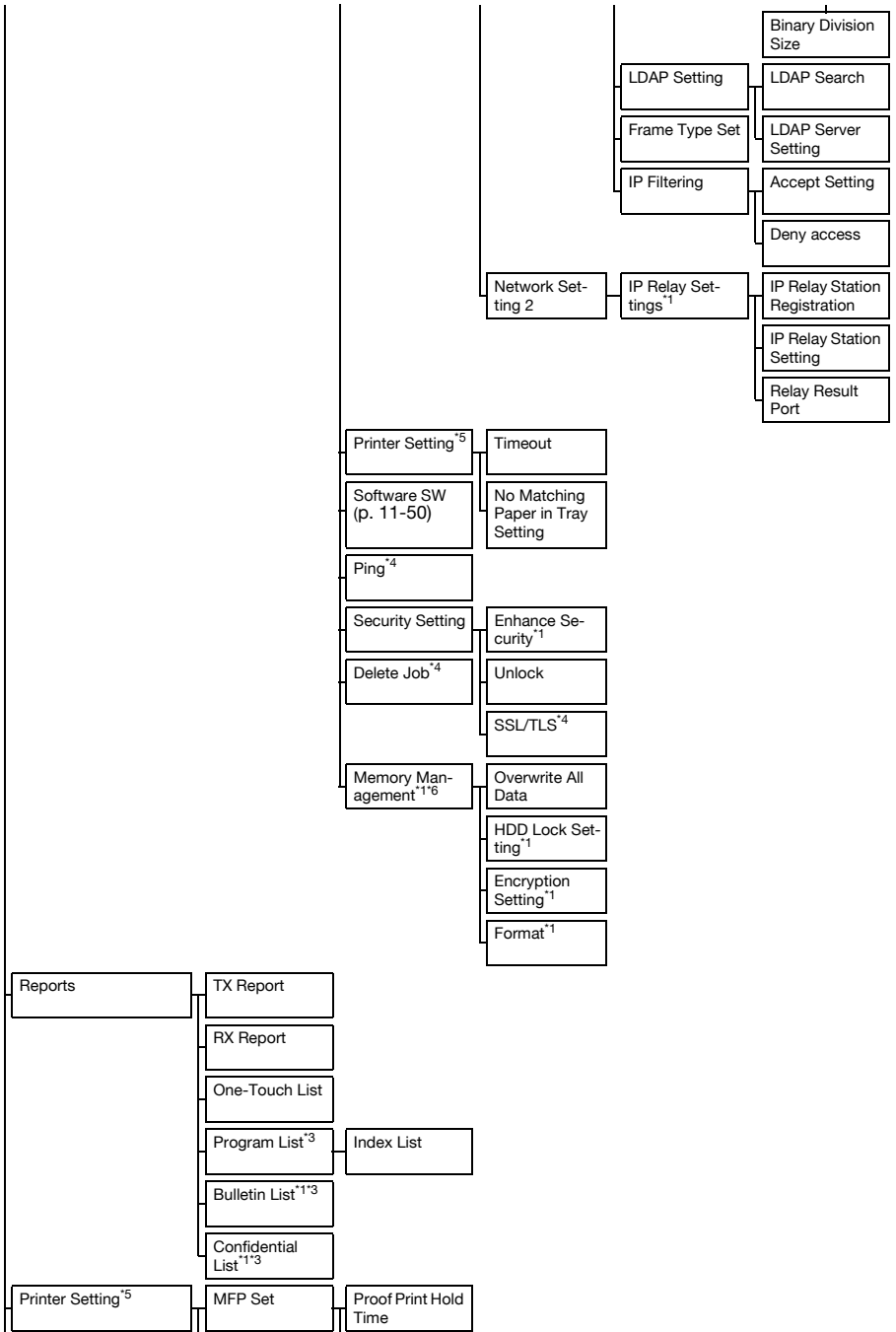



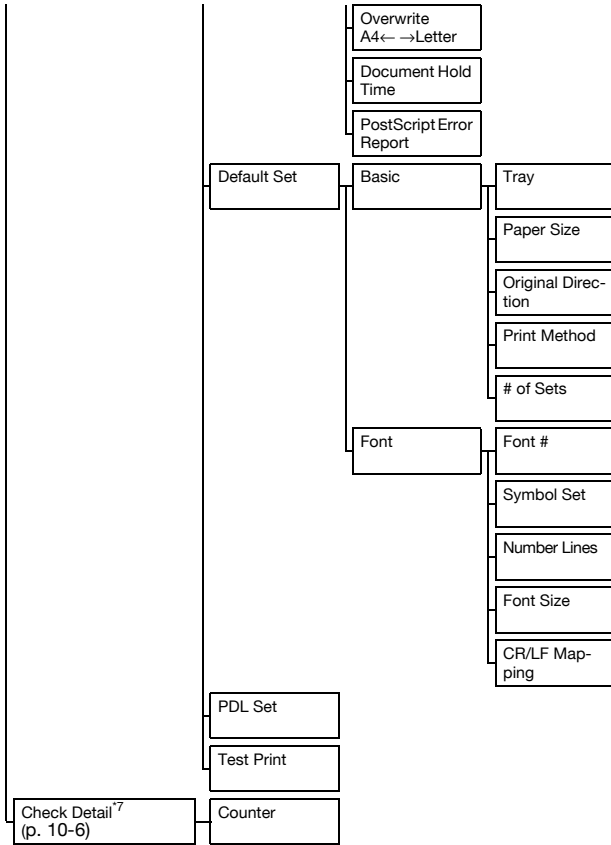

## 11.2 Specifying User's Choice settings

From the User's Choice screens, the default settings (settings selected when the machine is turned on) can be specified.

The following procedure describes how to display the User's Choice screens and specify its settings.

### To specify User's Choice settings

- 1 Press the [Utility/Counter] key.  
The Utility/Counter screen appears.
- 2 Touch [User Setting].

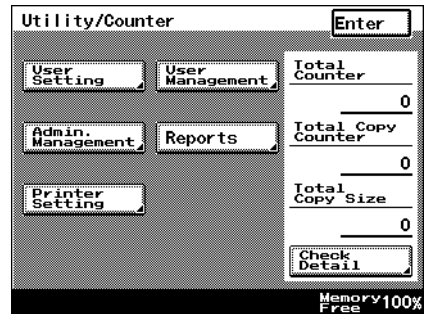

- 3 Touch [User's Choice].  
The User's Choice screen appears.



- 4 Select a tab, and then select a parameter to be set.

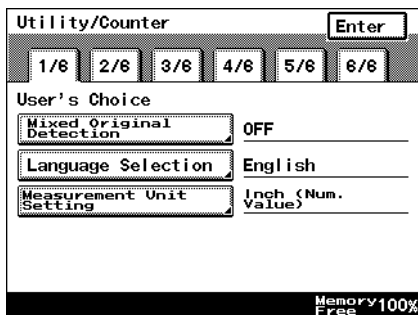

- 5 Specify the desired settings, and then touch [Enter].
- To cancel changes to the settings, touch [Cancel].
  - To exit the User's Choice screens, touch [Enter] in each screen until the Basics screen appears.

### Mixed Original Detection

Tab	Parameter	Description	Default Setting
1/6	Mixed Original Detection	Specify whether or not the "Mixed Original" setting is selected as a default.	OFF

### Language Selection

Tab	Parameter	Description	Default Setting
1/6	Language Selection	Select one of the following as the language in which messages appear in the touch panel. English, French, Spanish, Japanese	English



#### Note

*If user authentication is performed to log onto the machine, then the display language is changed, it will no longer be possible to log on to the machine normally with the next authentication. In this case, it will be necessary to change the software switch settings. For details, contact your technical representative.*

## Measurement Unit Setting

Tab	Parameter	Description	Default Setting
1/6	Measurement Unit Setting	Select one of the following as the measurement units in which values are displayed in the touch panel. mm (Num. Value), Inch (Num. Value), Inch (Fraction)	Inch (Num. Value)

## Machine Authentication PW Change

Tab	Parameter	Description	Default Setting
1/6	Machine Authentication PW Change	The password entered for machine authentication with user authentication can be changed. <ul style="list-style-type: none"> <li>• Current Password: Type in the currently specified machine authentication password.</li> <li>• New Password: Type in the new machine authentication password.</li> <li>• Confirm New Password: Type in the new machine authentication password again for confirmation.</li> </ul>	-



### Note

*This parameter appears only when the machine is being used with the machine user authentication settings specified.*

## Default Setting Simplex/Duplex

Tab	Parameter	Description	Default Setting
2/6	Default Setting Simplex/Duplex	Select one of the following as the default Single/Double-Sided setting. If the "Simplex -> Duplex" parameter in the Tech. Rep. Choice screen is set to "duplex only", [1→1] does not appear. For details, contact your technical representative. 1→2, 2→2, 1→1	1→1

## Auto Paper/Auto Zoom

Tab	Parameter	Description	Default Setting
2/6	Auto Paper/Auto Zoom	Select one of the following as the default setting. Auto Paper Select, Auto Zoom, Manual	Auto Paper Select

## Priority Tray

Tab	Parameter	Description	Default Setting
2/6	Priority Tray	Select which of the four paper trays is given priority when the “Auto Paper Select” setting is not selected.	1st tray

## Special Paper Setting

Tab	Parameter	Description	Default setting
2/6	Special Paper Setting	One of the following special paper settings can be selected for each paper tray. A paper tray set for special paper is not selected automatically when the “Auto Paper Select” setting is specified or when the automatic paper-tray-switching operation is performed and its priority order is not changed. Normal, Single Sided Only, Recycled, Special Paper	Normal



### Note

*If a special setting is specified for a paper tray, the icon for the special paper setting appears on the button for the paper tray.*



### Detail

*For details on the special paper, refer to “Special paper” on page 7-5.*

## Zoom Ratio for Combine/Booklets

Tab	Parameter	Description	Default setting
2/6	Zoom Ratio for Combine/Booklets	Select whether or not the appropriate zoom ratio is automatically recalled when an Orig. > Copy setting or the “Booklet” function is used. <ul style="list-style-type: none"> <li>Recall: <p>The zoom ratio for the “4-in-1” setting is <math>\times 0.500</math>, and the zoom ratio for the “2-in-1” setting and the “Booklet” function is <math>\times 0.647</math>.</p> </li> <li>Do not Recall: <p>No zoom ratio is selected automatically.</p> </li> </ul>	Recall

## Low Power Mode

Tab	Parameter	Description	Default setting
3/6	Low Power Mode	Specify the desired length of time (between 1 and 240 minutes) until the machine enters Low Power mode.	15 minutes

## Sleep Mode

Tab	Parameter	Description	Default setting
3/6	Sleep Mode	Specify the desired length of time (between 1 and 240 minutes) until the machine enters Sleep mode.	1 minute



### Detail

If the “Disable Sleep Mode” parameter in Administrator Management is set to “Yes”, [OFF] appears and users can select whether or not the Sleep mode is disabled. For details, refer to “Disable Sleep Mode” on page 11-26.

## LCD Back-Light OFF

Tab	Parameter	Description	Default setting
3/6	LCD Back-Light OFF	Specify the desired length of time (between 1 and 240 minutes) until the touch panel automatically goes off.	1 minute

## Auto Reset

Tab	Parameter	Description	Default setting
3/6	Auto Reset	Select the desired length of time until the automatic panel reset operation is performed and all settings return to their defaults. This parameter cannot be set to “OFF” if “Enhance Security” is set to “ON” and a user is logged on while user authentication settings are specified. If this parameter was set to “OFF” before “Enhance Security” is set to “ON”, the setting for this parameter changes to “1 min.” when “Enhance Security” is set to “ON”. 30 seconds, 1 min., 2 min., 3 min., 5 min., OFF	1 min.

## Auto Reset when Account is changed

Tab	Parameter	Description	Default setting
3/6	Auto Reset when Account is changed	Select whether or not the settings are reset to their defaults when an access code is entered or the key counter has been removed.	ON

## 4in1 Copy Order

Tab	Parameter	Description	Default setting
4/6	4in1 Copy Order	Select one of the following as the page order when the "4-in-1" Orig. > Copy setting is selected. Upper left→Upper right→Lower left→Lower right, Upper left→Lower left→Upper right→Lower right	Upper left→Upper right→Lower left→Lower right

## Default Quality/Density Modes

Tab	Parameter	Description	Default setting	
4/6	Default Quality/ Density Modes	Density	Select one of the following as the default copy density setting. Auto, Manual	Auto
		Original Type	Select one of the following as the default original type setting. Text, Photo, Text & Photo, Dot Matrix	Text

## Default Copy Output Levels

Tab	Parameter	Description	Default setting	
4/6	Default Copy Output Levels	For Auto Mode:	Select one of the following as the default copy density setting when the setting is specified automatically. Lighter, Std., Darker	Std.
		For Manual Mode:	Touch [Light] and [Dark] to select one of the nine levels for the default copy density when the setting is specified manually.	Middle of the nine levels

## Print Density

Tab	Parameter	Description	Default setting
4/6	Print Density	Select one of the following as the default printing density. -2, -1, 0, 1, 2	0

## Default Finishing Mode

Tab	Parameter	Description	Default setting
4/6	Default Finishing Mode	Select one of the following as the default sorting setting. Non-Sort, Sort, Group	Non-Sort
		Select one of the following as the default Finishing setting. Corner Staple, 2 Staples, 2-Hole Punch, 3-Hole Punch	Not specified



### Note

*[Corner Staple] and [2 Staples] appear only if optional finisher is installed.*

*[Hole Punch] appears only if optional punch unit is installed.*

## Sort/Non-Sort Auto Change

Tab	Parameter	Description	Default setting
5/6	Sort/Non-Sort Auto Change	Select whether the "Sort" or "Uncollated" setting is automatically selected according to the number of copy pages.	ON



### Detail

*If the "Sort/Non-Sort Auto Change" parameter is set to "ON", the "Uncollated" setting is selected when only one page was copied, and the "Sort" setting is selected when two or more pages are copied.*



## Output Tray Settings

Tab	Parameter			Description	Default setting
5/6	Output Tray Settings	Faxes/Prints	Fax	Select the output tray for data received at the fax port.	1 (output tray 1)
			Port 2	Select the output tray for data received at port 2 when the multi port is installed.	1 (output tray 1)
		Faxes/Prints	Select the output tray for data received from the network.	1 (output tray 1)	
		Copier/Printer	Printer	Specify the output tray for computer printouts.	1 (output tray 1)
		Copies	Specify the output tray for copies.	2 (output tray 2; when the job separator is installed) 1 (output tray 1; when the finisher is installed)	



### Detail

*If the optional output tray are installed on the finisher, the factory default setting for "Copy" is "3" (optional output tray).*



### Note

*The "Output Tray Settings" parameter appears only if optional finisher or job separator is installed.*

## Auto Paper Select for Small Orig.

Tab	Parameter	Description	Default setting
5/6	Auto Paper Select for Small Original	Select whether or not to specify a paper tray when the "Auto Paper Select" setting is selected and either no document is placed on the original glass or the document placed on the original glass is smaller than 5-3/4 × 8-1/4. <ul style="list-style-type: none"> <li>• ON: Copies are produced using the paper given priority.</li> <li>• Prohibit Copy: The screen for selecting a paper tray is displayed.</li> </ul>	ON

## Crease/Center Staple

Tab	Parameter	Description	Default setting
5/6	Crease/ Center Staple	Specify the crease and center staple position for each paper size. Select a paper size to be set, and then touch [Enter]. <ul style="list-style-type: none"> <li>• Crease: Specify the position of the fold (between -10 and +10).</li> <li>• Center Staple: Specify the position of the center staple (between -10 and +10).</li> </ul>	Crease: 0 Center Staple: 0



### Note

*The “Crease/Center Staple” parameter appears only if optional finisher or saddle stitcher is installed.*

## Default Screen

Tab	Parameter		Description	Default setting
6/6	Default Screen	Default LCD Screen	Select one of the following as the mode screen given priority. Copy, E-Mail, Scanner	Copy
		Default E- mail Screen	Select one of the following as the Fax mode screen given priority. One-Touch, Search, Address In- put, Index	One-Touch



### Note

*The names of parameters and settings may be different when fax kit is installed.*



### Detail

*The Default LCD Screen setting specifies the default screen when the automatic panel reset operation is performed or the machine is turned off, then on again.*

*In order to check the setting after it has been changed, turn the machine off with the main power switch, and then wait about 10 seconds before turning it on again. The machine may not operate correctly if it is turned on immediately after being turned off. For details on turning the machine off and on, refer to “Turning on the main power and the auxiliary power” on page 2-22.*

## Default Device

Tab	Parameter	Description	Default setting
6/6	Default Device	Select one of the following as the mode given priority. Copy, Printer	Copy

## Image Quality (ADF)

Tab	Parameter	Description	Default setting
6/6	Image Quality (ADF)	Select one of the following as the image quality level for the ADF. <ul style="list-style-type: none"> <li>• Left: Mode1 (for density correction) For reproducing faint documents, such as those written in pencil</li> <li>• Right: Mode2 (standard) For normal documents</li> </ul>	Left: Mode1 (for density correction)

## 11.3 Specifying User Management settings

From the User Management screen, settings for more comfortable use of the machine can be specified, such as the volume.

The following procedure describes how to display the User Management screen and specify its settings.

### To specify user management settings

- 1 Press the [Utility/Counter] key.  
The Utility/Counter screen appears.

- 2 Touch [User Management].  
The User Management screen appears.

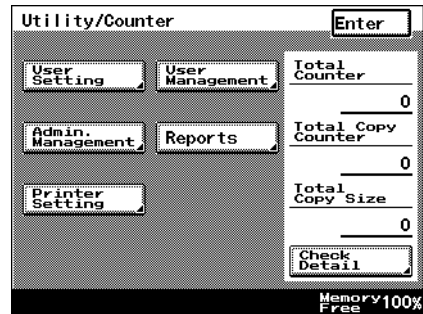

- 3 Select a parameter to be set.

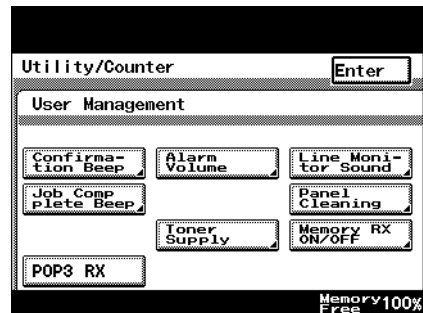

- 4 Specify the desired settings, and then touch [Enter].
  - To cancel changes to the settings, touch [Cancel].
  - To exit the User Management screen, touch [Enter] in each screen until the Basics screen appears.

**Detail**

*For details on the “Print Management” and “POP3 RX” parameters, refer to the User’s Guide [Facsimile Operations].*

**Tone volume parameters**

In the User Management screen, sound levels can be specified for the “Confirmation Beep”, “Alarm Volume”, “Line Monitor Sound”, and “Job Complete Beep” parameters.

Parameter	Description	Default setting
Confirmation Beep	Specify the volume (between 0 and 5) of the tone produced when a key is pressed.	3
Alarm Volume	Specify the volume (between 0 and 5) of the tone produced when an alarm is sounded.	3
Line Monitor Sound	Specify the volume (between 0 and 5) of the sound produced when a transmission is being monitored.	3
Job Complete Beep	Specify the volume (between 0 and 5) of the tone produced when a job is completed.	3

**Note**

*The “Line Monitor Sound” parameter appears only if the optional fax kit is installed.*

**Panel Cleaning**

Parameter	Description
Panel Cleaning	A screen is displayed so the control panel can be cleaned.

**Note**

*To exit the Panel Cleaning screen, press the [Reset] key.*

**Toner Supply**

Parameter	Description
Toner Supply	Select this parameter if the copies have become faint, for example, immediately after the toner bottle is replaced or after copying a large quantity of documents with large printed areas.

## 11.4 Displaying the Administrator Management screen

In order to change Administrator Management settings, display the Administrator Management screen.



### Reminder

*Be sure to keep the administrator access code in a safe place. If the administrator access code is lost while “Enhance Security” is set to “ON”, Administrator Management settings can no longer be specified. In this case, the administrator access code cannot be specified again. For details, contact your technical representative.*

### To display the Administrator Management screen

- 1 Press the [Utility/Counter] key.  
The Utility/Counter screen appears.

- 2 Touch [Admin. Management].  
The Administrator Code screen appears.

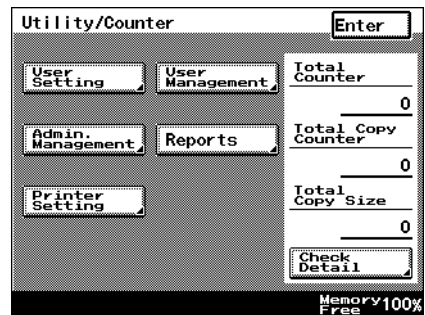

- 3 Use the keypad to type in the 8-digit administrator access code, and then touch [Enter].
  - To change the entered value, press the [C] (clear) key, and then enter the correct value.
  - To cancel changes to the settings, touch [Cancel].



The Administrator Management screen appears.

#### 4 Touch [Admin. 1] or [Admin. 2].

- To exit the Administrator Management screen, touch [Enter] in each screen until the Basics screen appears.

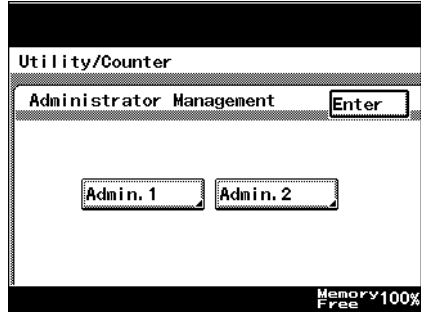

Administrator Management 1 screen

The Administrator Management 1 or Administrator Management 2 screen appears.

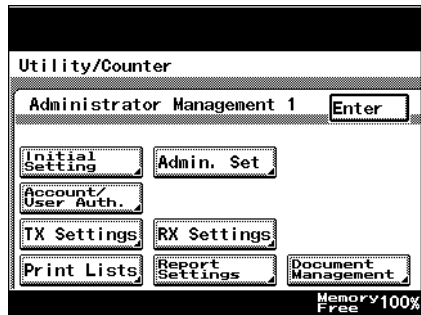

Administrator Management 2 screen



#### Detail

For details on the administrator access code, refer to “Administrator Code Input” on page 11-26.

## 11.5 Specifying Initial Settings

From the Initial Settings screen, the date and time and time zone can be specified.

The following procedure describes how to display the Initial Settings screen and specify its settings.

### To specify initial settings

- 1 Display the Administrator Management 1 screen, and then touch [Initial Settings].
  - For details on displaying the Administrator Management 1 screen, refer to “Displaying the Administrator Management screen” on page 11-21.

The Initial Settings screen appears.

- 2 Select a parameter to be set.

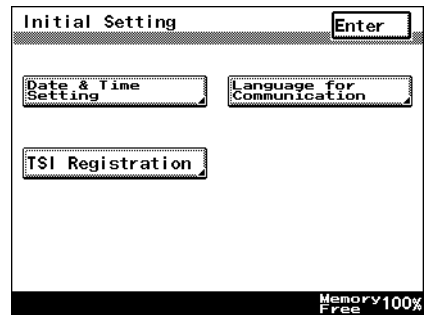

- 3 Specify the desired settings, and then touch [Enter].
  - To cancel changes to the settings, touch [Cancel].
  - To exit the Initial Settings screen, touch [Enter] in each screen until the Basics screen appears.



#### Detail

*For details on specifying parameters other than the “Date & Time Setting” parameter, refer to the User’s Guide [Facsimile Operations].*



## Date & Time Setting

Parameter		Description	Default setting
Date & Time Setting	Date & Time Setting	Specify the year, month, day, hour (24-hour time format), and minutes for the machine's internal clock.	-
	Time Zone	Specify the time zone (between -12:00 and +13:00 in 30-minute increments).	-
	Day Light Saving Time	Specify whether or not the machine's internal clock will follow daylight saving time.	-

## 11.6 Specifying Administrator settings

From the Administrator Set screen, the administrator access code can be changed or limits can be specified on the number of copies allowed.

The following procedure describes how to display the Administrator Set screen and specify its settings.

### To specify administrator settings

- 1 Display the Administrator Management 1 screen, and then touch [Admin. Set].
  - For details on displaying the Administrator Management 1 screen, refer to “Displaying the Administrator Management screen” on page 11-21.

The Administrator Set screen appears.

- 2 Select a parameter to be set.

The screenshot shows the 'Administrator Set' screen with the following settings:

Parameter	Value
Administrator Code Input	
Max. Copy Sets	OFF
Disable Sleep Mode	No
Restrict One-Touch Editing	OFF
Activity Report E-Mail TX	

At the bottom right of the screen, it indicates 'Memory Free 100%'.

- 3 Specify the desired settings, and then touch [Enter].
  - To cancel changes to the settings, touch [Cancel].
  - To exit the Administrator Set screen, touch [Enter] in each screen until the Basics screen appears.



#### Detail

For details on specifying the “Restrict One-Touch Editing”, “One-Touch” and “Activity Report E-Mail TX” parameters, refer to the User’s Guide [Facsimile Operations].

## Administrator Code Input

Parameter	Description	Default setting
Administrator Code Input	<p>The 8-digit administrator access code entered in the Administrator Code screen can be changed.</p> <ul style="list-style-type: none"> <li>• Current Code: Type in the currently specified administrator access code.</li> <li>• New Code: Type in the new administrator access code.</li> <li>• Retype New Code: Type in the new administrator access code again for confirmation.</li> </ul>	12345678



### Note

*To change the entered value, press the [C] (clear) key, and then enter the correct value.*

## Max. Copy Sets

Parameter	Description	Default setting
Max. Copy Sets	Specify the number of copies that can be specified (between 1 and 99 or "OFF").	OFF

## Disable Sleep Mode

Parameter	Description	Default setting
Disable Sleep Mode	<p>Select whether or not the setting for disabling Sleep mode is available.</p> <p>This parameter does not appear if user authentication settings have been specified on this machine.</p>	No

## 11.7 Specifying the account/authentication settings (User Authentication ON/OFF parameters)

User authentication and account track settings can be specified to control the use of this machine.

User authentication settings are specified to manage individuals, and account track settings are specified to manage groups of users.

- User authentication can be performed by the machine or by an external server.
- With machine authentication, the number of prints and scans made by each user can be counted.
- With external server authentication, the personal boxes of each user can be managed.
- By specifying account track settings, the number of prints and scans made by each account can be counted and limits can be specified on the number of prints allowed.

The following procedure describes how to specify settings in the User Authentication ON/OFF screen.



### Detail

*If an authentication method is set, the authentication screen is displayed while this machine is in standby. In order to use this machine when user authentication or account track settings are specified, the user/account name and password must be entered. For details, refer to “Controlling machine use with user authentication (machine authentication)” on page 2-30.*

*User authentication and account track can be used at the same time. In addition, specified user authentication and account track settings can be synchronized.*

### To specify the account/authentication settings

- ✓ The user authentication status (“ON (External Server)” or “ON (MFP)” or “Account Track”, whichever was specified in the User Authentication ON/OFF screen, appears in the Account/Authentication screen.

- 1 Display the Administrator Management 1 screen, and then touch [Account/User Auth.].
  - For details on displaying the Administrator Management 1 screen, refer to “Displaying the Administrator Management screen” on page 11-21.

The Account/Authentication screen appears.

- 2 Touch [User Authentication ON/OFF].

The User Authentication ON/OFF screen appears.

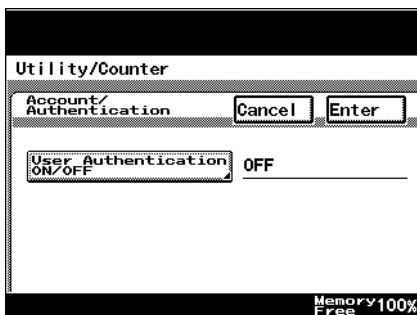

- 3 Specify the desired settings, and then touch [Enter].

- Specify settings for the “User Authentication”, “Account Track” and “Synchronize” parameters. The “Synchronize” parameter can be specified only if the “User Authentication” and “Account Track” parameters have been set. For details on specifying the settings, refer to “Specifying account data settings” on page 11-31 and “Specifying user authentication settings” on page 11-38.
  - To cancel changes to the settings, touch [Cancel].
- A screen appears, requesting confirmation to change the settings.

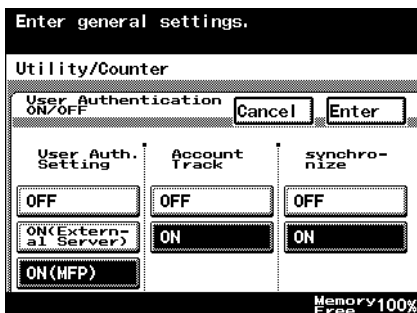

- 4 Touch [Yes], and then touch [Enter].
- If [Yes], then [Enter] was touched, the machine is restarted and all account track and user authentication data is initialized.
  - To exit the Account/ Authentication screen, touch [Enter] in each screen until the Basics screen appears.

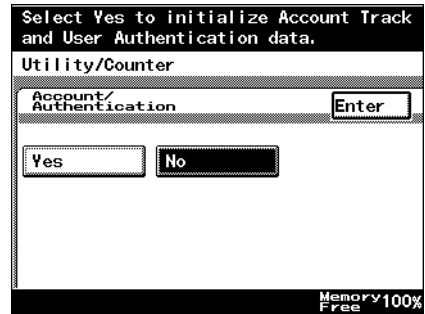

Restart the machine, and then the login screen appears after the machine has finished warming up.

### User Authentication ON/OFF

Parameter	Description	Default setting
User Auth. Setting	Specify whether or not user authentication settings are to be applied. Select one of the following as the user authentication method. <ul style="list-style-type: none"> <li>• ON (External Server): Select this setting to apply the user authentication function of an external server.</li> <li>• ON (MFP): Select this setting to apply the machine's user authentication function.</li> <li>• OFF: Select this setting to apply no user authentication function.</li> </ul>	OFF
Account Track	Select whether or not account track settings are to be applied.	OFF
Synchronize	Select whether or not use of the machine is controlled with user authentication and account track synchronized.	OFF

### Allow Print without Authentication

Parameter	Description	Default setting
Allow Print without Authentication	Select whether or not to permit printing of data with no user and account specified during computer printing while the user is logged on with user authentication or account track settings have been specified on the machine.	OFF

**Note**

*The “Allow Print without Authentication” parameter does not appear if “ON (External Server)” was selected in the User Authentication ON/OFF screen.*

## 11.8 Specifying account data settings

A password and the number of prints allowed can be specified and the counters can be controlled for each account using this machine.

The following procedure describes how to display the desired account.

### To display the desired account

- ✓ [Account Track Setting] appear only if the “Account Track” parameter is set to “ON”.
- ✓ A maximum of 1,000 accounts can be registered on this machine.

1 Display the Administrator Management 1 screen, and then touch [Account/User Auth.].

- For details on displaying the Administrator Management 1 screen, refer to “Displaying the Administrator Management screen” on page 11-21.

The Account/Authentication screen appears.

2 Touch [Account Track Setting].

The Account Data screen appears.

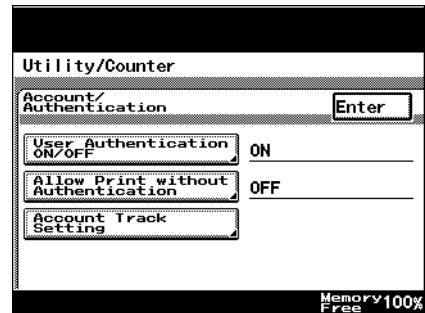

3 Touch the button for the range of accounts that includes the desired account.

- To immediately display the desired account, touch [Account #], and then use the keypad to type in the account number.

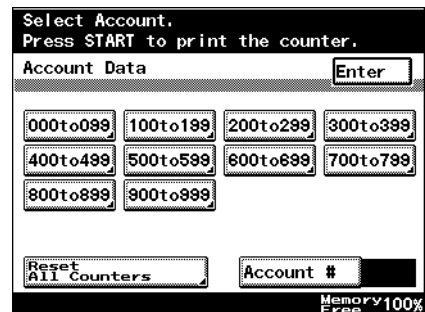

The screen for the selected range of account numbers appears.



- 4 Select an account number.
- Select a tab, and then touch the button for the desired account number.
  - To exit the Account/Authentication screen, touch [Enter] in each screen until the Basics screen appears.

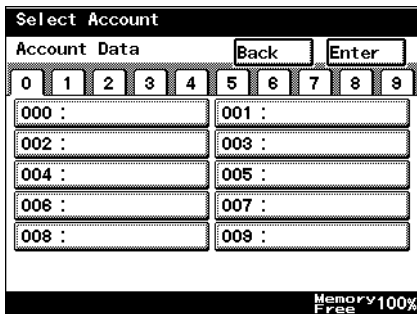

### To register an account

The account name, password, and number of prints allowed can be specified for each account using this machine.

- ✓ A maximum of 1,000 accounts can be registered on this machine.
- ✓ If user authentication and account track are synchronized, 100 accounts can be managed.

- 1 Display the Account Data screen, and then select an available account number.
- For details on displaying the Account Registr. screen, refer to “Specifying account data settings” on page 11-31.
- The Account Registr. screen appears.

- 2 Touch [Account Name].
- The Account Name screen appears.

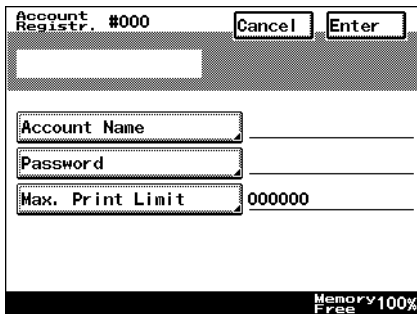

3 Type in the account name (up to 8 characters long), and then touch [Enter].

- To cancel changes to the settings, touch [Cancel].
- For details on typing in text, refer to “Entering text” on page 12-2.

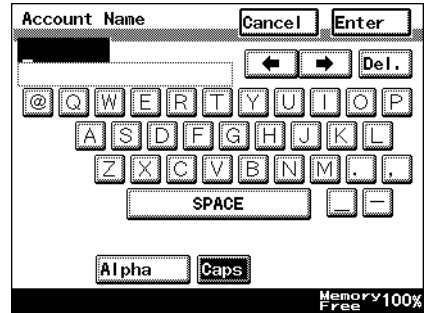

The Account Registr. screen appears again.

4 Touch [Password].



The Change Password screen appears.

5 Type in the password (up to 8 characters long), and then touch [Enter].

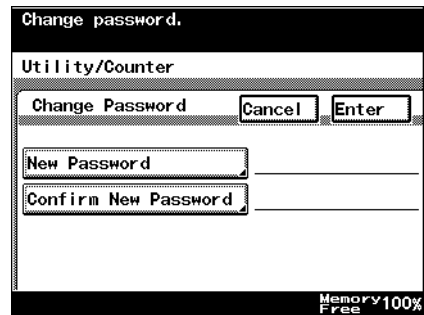
- Touch [New Password], type the new password into the screen that appeared, and then touch [Enter].
  - Touch [Confirm New Password], type the new password again into the screen that appeared, and then touch [Enter].
  - To change the password, touch [Current Password], type the current password into the screen that appeared, and then touch [Enter].
  - To cancel changes to the settings, touch [Cancel].
  - For details on typing in text, refer to “Entering text” on page 12-2.
- The Account Registr. screen appears again.



- 6 Touch [Max. Print Limit].  
The Max. Print Limit screen appears.

- 7 Touch  and  to move the cursor to the value to be changed, and then use the keypad to specify the maximum number of prints allowed.

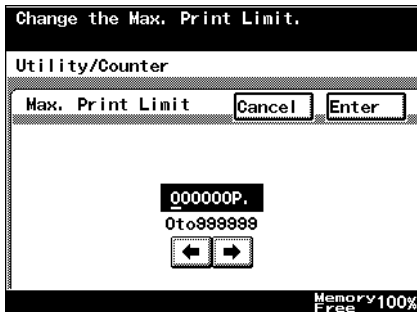

- The maximum number of prints allowed can be set between 0 and 999,999.
- If “0” is specified, there is no limit on the number of prints allowed.
- To cancel changes to the settings, touch [Cancel].

- 8 Touch [Enter], and then touch [Enter] in the next two screens that appear.
- To exit the Account/Authentication screen, touch [Enter] in each screen until the Basics screen appears.
- The screen for selecting an account number appears again.  
The new account is registered.



#### Note

*The account name appears on the button for the registered account number.*

### To manage an account

The settings for registered accounts can be changed and the counters can be controlled.

- ✓ The list of print counters for each account can be printed by pressing the [Start] key while the Detail screen is displayed.

- 1 Display the Account Data screen, and then select the desired account number.
- For details on displaying the Detail screen for an account, refer to “Specifying account data settings” on page 11-31.
- The Detail screen appears.

## 2 Select the desired settings.

- Touch [General Settings] to display the Account Registr. screen, and then change the settings.
- For details on changing settings in the Account Registr. screen, refer to "To register an account" on page 11-32.
- Touch [Clear Counter] to display a message confirming that the counters will be reset. To reset all counters for the selected account to 0, touch [Yes].
- Touch [Counter] to display the Counter screen, which contains the counters for the selected account.
- In the Counter screen, touch [Fwd] to display the next screen, or touch [Back] to display the previous screen.

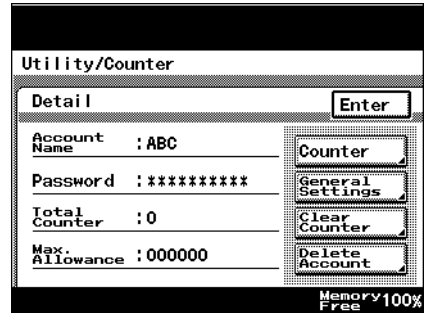

Counter screen

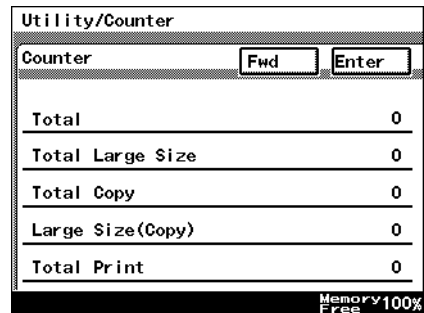

- ## 3 Touch [Exit], and then touch [Enter] in the next screen that appears.
- To exit the Account/Authentication screen, touch [Enter] in each screen until the Basics screen appears.
- The screen for selecting an account number appears again.



### Note

*In the screen for selecting an account number, touch [Reset All Counters], then [Yes], and then touch [Enter] to reset all counters for all accounts to 0.*

## To delete an account

- 1 Display the Account Data screen, and then select the desired account number.
  - For details on displaying the Detail screen for an account, refer to “Specifying account data settings” on page 11-31.

The Detail screen appears.

- 2 Touch [Delete Account].
  - If this machine is being used with account track settings specified, [Delete Account] does not appear for accounts that have been authenticated.

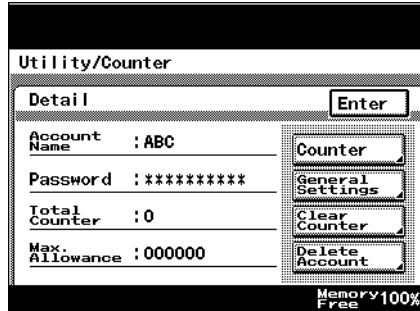

- 3 Touch [Yes], touch [Enter], and then touch [Enter] in the next screen that appears.
  - To exit the Account/Authentication screen, touch [Enter] in each screen until the Basics screen appears.

The screen for selecting an account number appears again.  
The account is deleted.



## Allowing printing without authentication

- 1 Display the Administrator Management 1 screen, and then touch [Account/User Auth.].
  - For details on displaying the Administrator Management 1 screen, refer to “Displaying the Administrator Management screen” on page 11-21.

The Account/Authentication screen appears.

- 2 Touch [Allow Print without Authentication].

The Allow Print without Authentication screen appears.

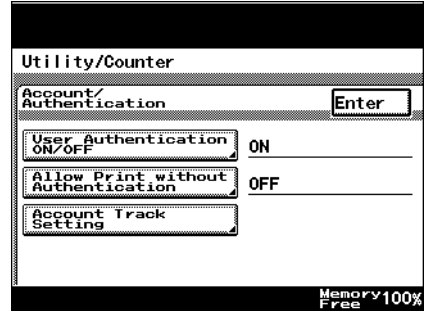

- 3 Touch [ON], and then touch [Enter].
  - If “ON” is selected, printing is possible regardless of whether an account is specified.
  - If “OFF” is selected, a document cannot be printed if no account is specified.
  - To cancel changes to the settings, touch [Cancel].

The Account/Authentication screen appears again.



## 11.9 Specifying user authentication settings

User authentication can be performed by the external server or by the machine. With external server authentication, limitations can be placed on the users who have access to this machine. With machine authentication, a password can be specified for each user and their counters can be controlled.

### To display the User Authentication screen

- ✓ If “ON (External Server)” was selected in the User Authentication ON/OFF screen, [External Server Authentication] appears in the Account/Authentication screen. If “ON (MFP)” was selected, [Machine Auth. Setting] appears in the Account/Authentication screen. For details, refer to “Specifying the account/authentication settings (User Authentication ON/OFF parameters)” on page 11-27.
- ✓ A maximum of 100 users can be registered on this machine.

**1** Display the Administrator Management 1 screen, and then touch [Account/User Auth.].

- For details on displaying the Administrator Management 1 screen, refer to “Displaying the Administrator Management screen” on page 11-21.

The Account/Authentication screen appears.

**2** Touch [External Server Authentication] or [Machine Auth. Setting].

- To exit the User Authentication screen, touch [Enter] in each screen until the Basics screen appears.

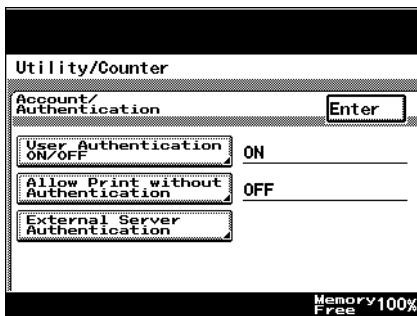

The User Authentication screen for either external server authentication or machine authentication appears.

External server authentication settings

Machine authentication settings



### Detail

*Depending on the network environment, it may take some time to log on with external server authentication. Selecting the following settings may reduce the logon time.*

- Specify a server compatible with Active Directory for DNS server address 1.
- With DNS server address 1, register an SRV record for LDAP and Kerberos for a server compatible with Active Directory.

*For more details, refer to the User's Guide [Network Scanner Operations].*



## To register a user with external server authentication

A user can be registered when external server authentication is used.

- 1 Display the User Authentication screen for external server authentication.
  - For details on displaying the User Authentication screen, refer to “Specifying user authentication settings” on page 11-38.

- 2 Touch [General Settings].  
The General Settings screen appears.

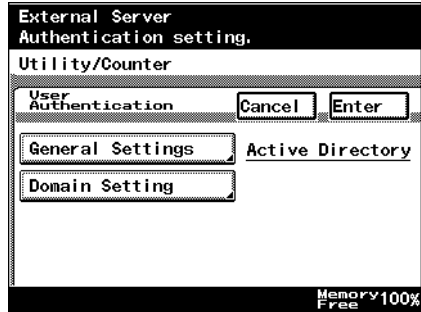

- 3 Select the authentication system, and then touch [Enter].

- To cancel changes to the settings, touch [Cancel].
- If the software switch settings are specified to synchronize external server authentication and LDAP authentication, select “Active Directory”. For details on the software switch settings, refer to “Specifying software switch settings (machine functions)” on page 11-50.

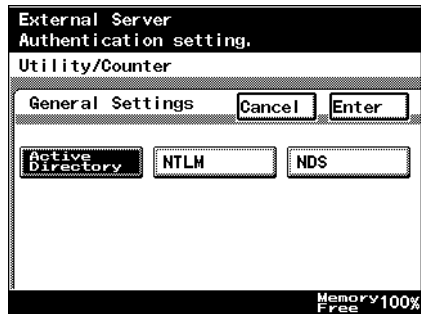

The User Authentication screen appears again.

#### 4 Touch [Domain Setting].

- If a domain name is already registered, touch [Default Domain Name] in the User Authentication screen for external server authentication, and then select the default domain name.
- The domain name registered in the first line (upper left) of the Domain Setting screen is the default.
- A maximum of 10 domain names can be registered with Active Directory.

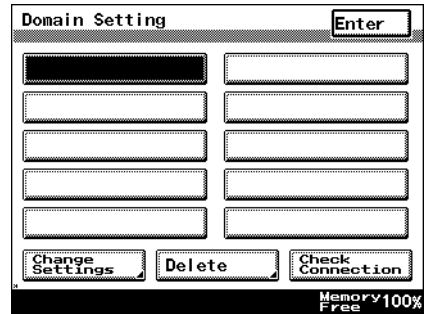

The Domain Setting screen appears.

#### 5 Perform the desired operation.

- To register a new domain name, select an empty button, and then touch [Change Setting].
- To change the name of a registered domain, select the button of the domain whose name is to be changed, and then touch [Change Setting].
- To delete a registered domain name, select the button of the domain to be deleted, and then touch [Delete].
- To check the connection with an external server, select the button of a registered domain name, and then touch [Check Connection].

The Domain Name screen appears.

#### 6 Type in the domain name, and then touch [Enter].

- If "NDS" was selected in the Authentication System screen, [Tree Name] and [Context Name] appear instead of [Domain Name]. Touch [Tree Name] or [Context Name], type in the tree name or context name, and then touch [Enter].
- For details on the domain name, tree name, and context name, refer to the User's Guide [Network Scanner Operations].

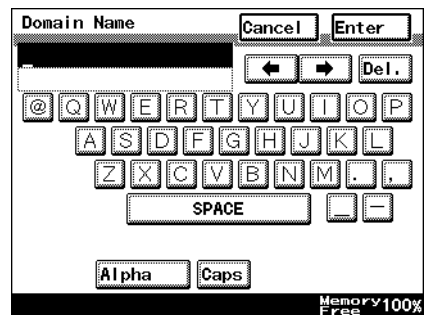

- To cancel changes to the settings, touch [Cancel].
- For details on typing in text, refer to “Entering text” on page 12-2. The Domain Setting screen appears again.

## 7 Touch [Enter].

The User Authentication screen appears again.

## 8 Touch [Enter].

- To exit the Account/Authentication screen, touch [Enter] in each screen until the Basics screen appears.

The external server user is registered.

### To register a user with machine authentication

A user can be registered when machine authentication is used.

- ✓ A maximum of 100 users can be registered on this machine.

## 1 Display the User Authentication screen for machine authentication.

- For details on displaying the User Authentication screen, refer to “Specifying user authentication settings” on page 11-38.

## 2 Touch [User Registration].

A screen for selecting a user number appears.

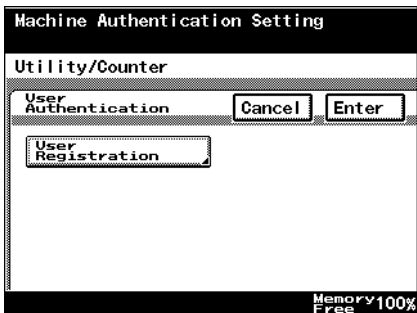

- 3 Select a user number.
- Select a tab, and then touch the button for an available user number.
  - To immediately display the desired user, touch [User Number], and then use the keypad to type in the user number.

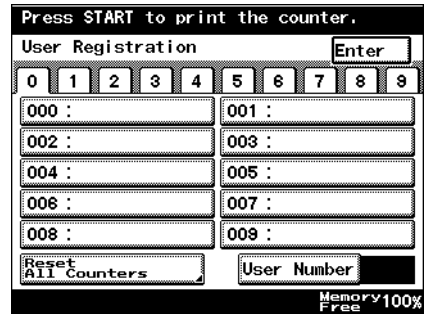

The User Reg. screen appears.

- 4 Touch [User Information].
- The User Info. screen appears.

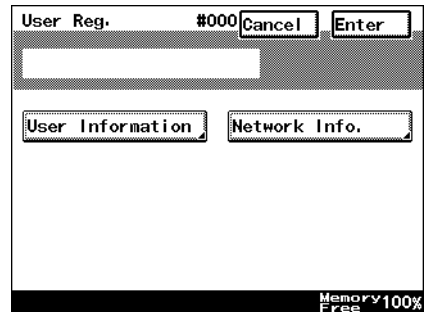

- 5 Touch [User Name].
- If machine authentication and account track are synchronized, [Account Name] appears in the User Info. screen. Touch [Account Name], and then specify the number of the account to be synchronized. For details on specifying account numbers, refer to “Specifying account data settings” on page 11-31.

The User Name screen appears.

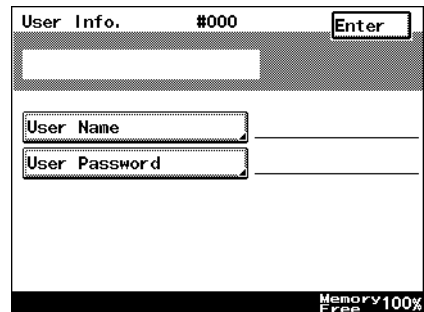

- 6 Type in the user name (up to 64 characters long), and then touch [Enter].
- To cancel changes to the settings, touch [Cancel].
- The User Info. screen appears again.

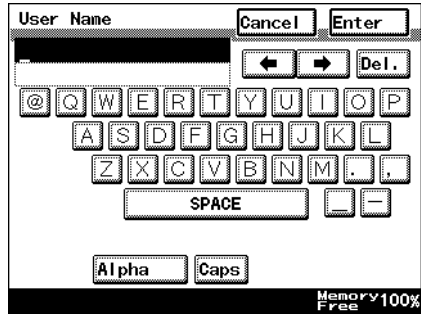

- 7 Touch [User Password].
- The password screen appears.

- 8 Type in the password (up to 32 characters long), touch [Enter], and then touch [Enter] in the next screen that appears.

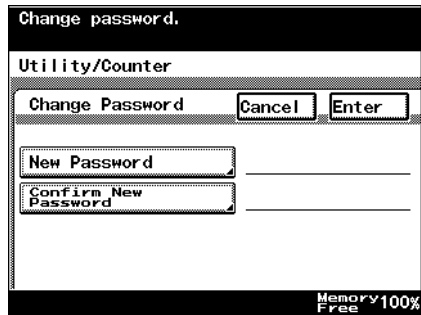

- Touch [New Password], type the new password into the screen that appeared, and then touch [Enter].
  - Touch [Confirm New Password], type the new password again into the screen that appeared, and then touch [Enter].
  - To change the password, touch [Current Password], type the current password into the screen that appeared, and then touch [Enter].
  - To cancel changes to the settings, touch [Cancel].
  - For details on typing in text, refer to “Entering text” on page 12-2.
- The User Information screen appears again.

- 9 Touch [Enter], and then touch [Enter] in the next screen that appears.
  - If a network is connected, touch [Network Info.], and then specify settings for “E-Mail Address”, “POP3 User Name”, “POP3 Password”, “SMTP User Name”, and “SMTP Password”. For details, refer to the User’s Guide [Network Scanner Operations].
  - The software switch settings can be specified so that user names and passwords registered with user authentication can be used in LDAP searches. For details on the software switch settings, refer to “Specifying software switch settings (machine functions)” on page 11-50. For details on LDAP searches, refer to the User’s Guide [Network Scanner Operations].
  - To exit the User Authentication screen, touch [Enter] in each screen until the Basics screen appears.

A screen for selecting a user number appears again.  
The machine authentication user is registered.

**Note**

*The user name appears on the button for the registered user number.*

## To manage a user for machine authentication

The settings for registered machine authentication users can be changed and the counters can be controlled.

- 1 Display the User Authentication screen for machine authentication.
  - For details on displaying the User Authentication screen, refer to “Specifying user authentication settings” on page 11-38.

- 2 Touch [User Registration].  
A screen for selecting a user number appears.

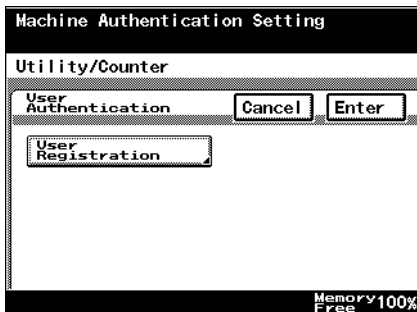

- 3 Select the desired user number.
  - Select a tab, and then touch the button for the desired user number.
  - To immediately display the desired user, touch [User Number], and then use the keypad to type in the user number.



The User Information screen appears.

- 4 Select the desired settings.
- Touch [General Settings] to display the User Registration screen, and then change the settings.
  - For details on changing settings for machine authentication users, refer to “To register a user with machine authentication” on page 11-42.
  - The list of print counters for each account can be printed by pressing the [Start] key while the Detail screen is displayed.
  - The list of print counters can be printed if only user authentication settings have been specified.
  - Touch [Clear Counter] to display a message confirming that the counters will be reset. To reset all counters for the selected user to 0, touch [Yes].
  - Touch [Counter] to display the Counter screen, which contains the counters for the selected user.

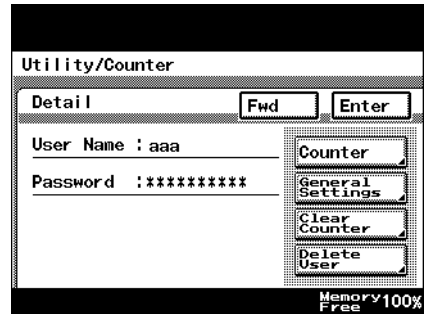

Counter screen

Utility/Counter	
Counter	
Total	0
Total Large Size	0
Total Copy	0
Large Size(Copy)	0
Total Print	0

- 5 Touch [Enter], and then touch [Enter] in the next screen that appears.
- To exit the User Authentication screen, touch [Enter] in each screen until the Basics screen appears.
- A screen for selecting a user number appears again.

**Note**

*In the User Information screen or Counter screen, touch [Fwd] to display the next screen, or touch [Back] to display the previous screen.*



## To delete a user for machine authentication

- 1 Display the User Authentication screen for machine authentication.
  - For details on displaying the User Authentication screen, refer to “Specifying user authentication settings” on page 11-38.

- 2 Touch [User Registration].
  - To immediately display the desired user, touch [User Number], and then use the keypad to type in the user number.

A screen for selecting a user number appears.

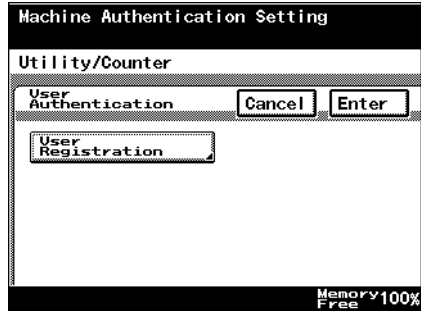

- 3 Select the desired user number.
  - Select a tab, and then touch the button for the desired user number.

The User Information screen appears.



- 4 Touch [Delete User].
  - If this machine is being used with machine authentication settings specified, [Delete User] does not appear for users that have been authenticated.



- 5 Select [Yes], and then touch [Enter].
- To exit the User Authentication screen, touch [Enter] in each screen until the Basics screen appears.
- A screen for selecting a user number appears again.

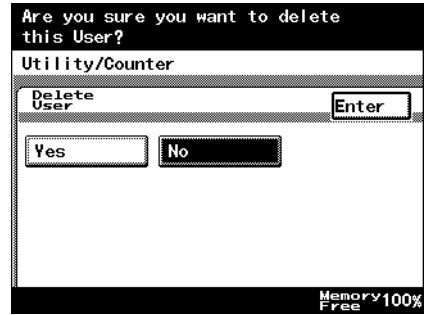

## 11.10 Specifying software switch settings (machine functions)

By specifying the software switch settings (“Mode Selection”, “Bit Selection” and “Hex Selection”), various machine functions can be changed to meet your specific needs.



### Reminder

*Do not change any modes or bits other than those described in this manual.*



### Note

*When “Enhance Security” is set to “ON”, the software switch settings cannot be changed.*

### Software SW settings

Parameter	Description
Mode Selection	Specify the three-digit number for the parameter that you wish to specify with the software switch settings.
Bit Selection	The bits are the eight numbers that construct the mode. By specifying a binary number (0 or 1) for each of the bits (0 through 7), each function can be specified.
HEX Selection	Specify a setting for each mode as a hexadecimal number (0 through 9 and A through F). For example, to specify the bit setting “0011 0000”, specify the hexadecimal setting “30”.

Reference: Examples of “Bit Selection” binary numbers and “HEX Selection” hexadecimal numbers

Decimal number	“Bit Selection” setting (binary number)	“HEX Selection” setting (hexadecimal number)
0	0000 0000	00
1	0000 0001	01
2	0000 0010	02
3	0000 0011	03
4	0000 0100	04
5	0000 0101	05
6	0000 0110	06
7	0000 0111	07

Decimal number	“Bit Selection” setting (binary number)	“HEX Selection” setting (hexadecimal number)
8	0000 1000	08
9	0000 1001	09
10	0000 1010	0A
11	0000 1011	0B
12	0000 1100	0C
13	0000 1101	0D
14	0000 1110	0E
15	0000 1111	0F
16	0001 0000	10
.	.	.
.	.	.
.	.	.
255	1111 1111	FF

### To specify a software switch setting

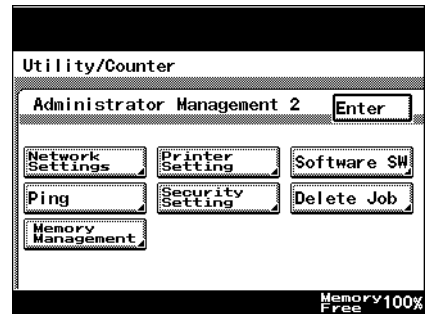

- 1 Enter Administrator mode, and then touch [Admin. 2].
- 2 Touch [Software SW].  
The soft SW Setting screen appears.

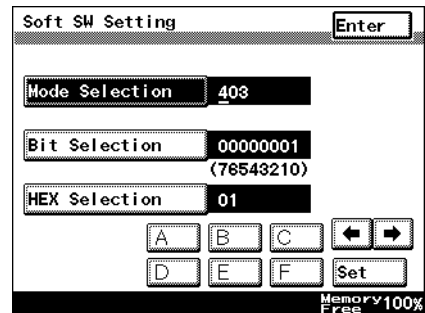

- 3 Touch [Mode Selection], and then use the keypad to type in the mode number.



4 Touch either [Bit Selection] or [HEX Selection], and then specify the setting.

- To specify the bits, touch [Bit Selection], touch  and  to move the cursor to the bit to be changed, press either the [0] or [1] key in the keypad to specify the bit, and then touch [Enter].

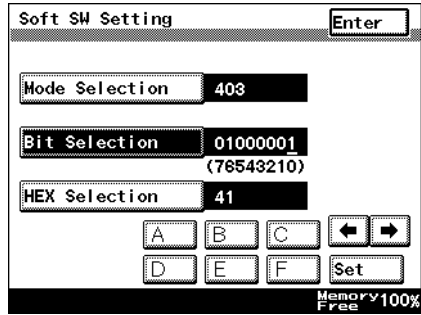

- To specify the hex value, touch [HEX Selection], specify the value by either using the keypad or touching [A] through [F], and then touch [Enter].

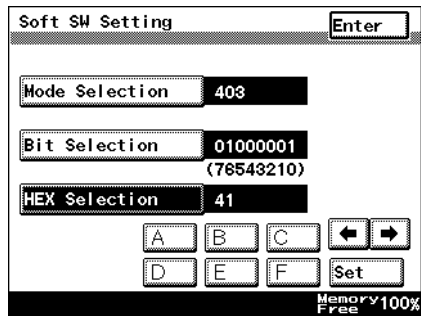

5 To change the setting for a different mode, repeat steps 3 and 4.

6 Touch [Enter] in each screen until the initial screen appears.

7 Turn the machine off, then on again.



#### Reminder

*When turning the main power switch off, then on again, wait about 10 seconds after turning the machine off before turning it on again. The machine may not operate correctly if it is turned on immediately after being turned off.*

### Specifying permissions for copy functions (mode 307)

The machine can be set so that copy functions cannot be used. In this case, the Basics screen does not appear, even after the [Copy] key is pressed.

Settings at time of purchase

Bit	7 6 5 4 3 2 1 0
Setting	0 0 0 0 0 0 0 0 (HEX: 00)

Specifying the setting

The shaded cells indicate the settings selected at the time of purchase.

Bit	Description	Setting	Description
7	Specify whether or not copy functions can be used.	0	Specifies that copy functions can be used.
		1	Specifies that copy functions cannot be used.
6, 5, 4, 3, 2, 1, 0	-----	0000000	* Do not change these bits when specifying settings for this function.

### Specifying the enlarged display method (mode 311)

Specify the method for displaying enlargements of screens.

Settings at time of purchase

Bit	7 6 5 4 3 2 1 0
Setting	0 0 0 0 0 0 0 0 (HEX: 00)

Specifying the setting

The shaded cells indicate the settings selected at the time of purchase.

Bit	Description	Setting	Description
7	-----	0	* Do not change this bit when specifying settings for this function.

Bit	Description	Setting	Description
6	Specify whether to enlarge the upper-left corner of the screen or wait for instructions on the area to display enlarged when the [Enlarge Display] key is pressed.	0	Waits for instructions on the area of the screen to be displayed enlarged.
		1	Enlarges the upper-left corner of the screen.
5, 4, 3, 2, 1, 0	-----	000000	*Do not change these bits when specifying settings for this function.

### Specifying that the “Auto Paper Select” setting and the “Auto Zoom” setting can be selected at the same time (mode 403)

If a paper tray is selected while the “Auto Paper Select” setting is specified, the “Auto Zoom” setting can be set automatically.

Settings at time of purchase

Bit	7 6 5 4 3 2 1 0
Setting	0 0 0 0 0 0 0 1 (HEX: 01)

### Specifying the setting

The shaded cells indicate the settings selected at the time of purchase.

Bit	Description	Setting	Description
7	-----	0	*Do not change this bit when specifying settings for this function.
6	Specifies the units used to display and specify lengths shown in the screens.	0	The “Auto Zoom” setting cannot be specified at the same time.
		1	The “Auto Zoom” setting can be specified at the same time.
5, 4, 3, 2, 1, 0	-----	000001	*Do not change these bits when specifying settings for this function.

**Specifying the measurement units (mode 426)**

Specify the units used to display and specify lengths shown in the screens.

Settings at time of purchase

Bit	7 6 5 4 3 2 1 0
Setting	0 1 0 1 0 0 0 0 (HEX: 50)

**Specifying the setting**

The grayed out cells are the settings at the time of purchase.

Bit	Description	Setting	Description
7, 6, 5	-----	010	*Do not change these bits when specifying settings for this function.
4, 3	Specifies the units used to display and specify lengths shown in the screens.	00	Displayed in millimeters (mm)
		01	Displayed in inches (decimals)
		10	Displayed in inches (fractions)
2, 1, 0	-----	000	*Do not change these bits when specifying settings for this function.

**Specifying settings when copying is finished using the ADF (mode 429)**

Specify whether or not all settings are reset when copying is finished using the ADF.

Settings at time of purchase

Bit	7 6 5 4 3 2 1 0
Setting	0 0 0 0 0 0 0 0 (HEX: 00)

**Specifying the setting**

The grayed out cells are the settings at the time of purchase.

Bit	Description	Setting	Description
7, 6	-----	00	*Do not change these bits when specifying settings for this function.



Bit	Description	Setting	Description
5	Specify whether or not all settings in the Basics screen are re-set when copying is finished using the ADF.	0	Automatic panel reset operation is not performed.
		1	Automatic panel reset operation is performed.
4, 3, 2, 1, 0	-----	00000	*Do not change these bits when specifying settings for this function.

### Specifying the pressing of the [Access] key when logging off (mode 438)

Select whether or not the [Access] key be pressed when logging off.

Settings at time of purchase

Bit	7 6 5 4 3 2 1 0
Setting	0 0 0 0 0 0 0 0 (HEX: 00)

Specifying the setting

The shaded cells indicate the settings selected at the time of purchase.

Bit	Description	Setting	Description
7, 6, 5	-----	000	*Do not change these bits when specifying settings for this function.
4	Specify whether or not the [Access] key be pressed when logging off.	0	Specifies that the [Access] key not be pressed when logging off.
		1	Specifies that the [Access] key be pressed when logging off.
3, 2, 1, 0	-----	0000	*Do not change these bits when specifying settings for this function.

### Specifying use of registered user authentication information to log on to the LDAP server (mode 466)

Specify whether or not user names and passwords registered with user authentication are used to log on to the LDAP server.

Settings at time of purchase

Bit	7 6 5 4 3 2 1 0
Setting	0 0 0 0 0 0 0 0 (HEX: 00)

### Specifying the setting

The shaded cells indicate the settings selected at the time of purchase.

Bit	Description	Setting	Description
7	Select whether or not the user name/password used for external server authentication is used to log on to the LDAP server.	0	Not used for logon
		1	Used for logon
6, 5, 4, 3, 2, 1, 0	-----	0000000	*Do not change these bits when specifying settings for this function.



#### Detail

*The information for the LDAP server to be connected to must be registered in order to use the LDAP server. In addition, when LDAP and user authentication is synchronized, select "Active Directory" as the user authentication method. Select "GSS-SPNEGO" as the LDAP authentication method. For details on the user authentication method, refer to "To register a user with external server authentication" on page 11-40. For details on the LDAP authentication method, refer to the User's Guide [Network Scanner Operations].*

### Specifying whether to enable access locks and password rules, and specifying the method for deleting image data (mode 469)

Specify whether to lock access if the password is entered incorrectly, specify whether to apply the password rules, and specify the method for deleting image data.

Settings at the time of purchase

Bit	7 6 5 4 3 2 1 0
Setting	0 0 0 0 0 0 0 0 (HEX: 00)

### Specifying the settings

The grayed out cells are the settings at the time of purchase.

Bit	Description	Setting	Description
7	Specify whether to lock access when a password (account track and administrator passwords) is entered incorrectly three times.	0	Does not lock access
		1	Locks access
6	Specify whether or not image data on the hard disk is overwritten to delete it.*1	0	Image data on the hard disk is not overwritten when it is deleted.
		1	Image data on the hard disk is overwritten when it is deleted.
5	-----	0	*Do not change this bit when specifying settings for this function.
4	For security, specify whether to apply a password rule.	0	Do not apply a password rule
		1	Apply a password rule
3, 2, 1, 0	-----	0000	*Do not change these bits when specifying settings for this function.

\*1 This setting is applied after the machine is turned off, then on again.



#### Detail

If “Enhance Security” is set to “ON”, the access lock, password rules and overwriting of temporary data are enabled. For details on the “Enhance Security” parameter, refer to “Specifying security settings (Security Setting parameters)” on page 11-62.

The access lock can be canceled with each password. For details, refer to “Canceling an access lock (“Unlock” parameter)” on page 11-66.

For details on the password rules, refer to “Password rules” on page 11-70.

**Note**

If bit 6 is set to "1", the scanning and printing speed may be reduced.

### Specifying the setting for displaying a list of users in the User Authentication screen (mode 471)

Specify whether or not [User List] appears in the screen for machine authentication and specify the screen that appears as a default when [User List] is touched.

Settings at time of purchase

Bit	7 6 5 4 3 2 1 0
Setting	0 0 0 0 0 0 0 0 (HEX: 00)

Specifying the setting

The grayed out cells are the settings at the time of purchase.

Bit	Description	Setting	Description
7, 6, 5, 4, 3	-----	00000	*Do not change these bits when specifying settings for this function.
2, 1	Specifies whether or not the user list is displayed and whether or not the user list is the default.	00	Does not display the user list.
		01	Displays the user list, but does not specify it as the default.
		11	Specifies the user list as the default.
0	-----	0	*Do not change this bit when specifying settings for this function.

### Specifying the deleting method for [Del.] in input screens (mode 478)

Specify the deleting method for [Del.] in input screens.

Select whether the character at the cursor's position or the character to the left of the cursor is deleted.

Settings at time of purchase

Bit	7 6 5 4 3 2 1 0
Setting	1 0 0 0 0 0 0 0 (HEX: 80)

## Specifying the setting

The grayed out cells are the settings at the time of purchase.

Bit	Description	Setting	Description
7	Specify the deleting method for [Del.] in input screens.	0	Deletes the character at the cursor's position
		1	Deletes the character to the left of the cursor
6, 5, 4, 3, 2, 1, 0	-----	0000000	*Do not change these bits when specifying settings for this function.

### Specifying settings for limiting user authentication to only Scan functions (mode 479)

Specify whether or not user authentication is performed only when the [Fax/Scan] or [Extra Scan] key is pressed.

Settings at time of purchase

Bit	7 6 5 4 3 2 1 0
Setting	0 0 0 0 0 0 0 0 (HEX: 00)

## Specifying the setting

The grayed out cells are the settings at the time of purchase.

Bit	Description	Setting	Description
7, 6, 5	-----	000	*Do not change these bits when specifying settings for this function.
4, 3, 2, 1, 0	Specifies whether or not to limit authentication on Fax and Scan functions.	11001	Limited
		00000	Not limited



...

**Reminder**

*Do not specify settings for mode 479 other than those described in “Specifying the setting”.*

**Detail**

*If user authentication is limited to Scan functions, touch [Account/User Auth.] in the Administrator Management 1 screen, and then select “External Server” as the user authentication method. For details on the user authentication method, refer to “Specifying the account/authentication settings (User Authentication ON/OFF parameters)” on page 11-27.*

## 11.11 Specifying security settings (Security Setting parameters)

When the “Enhance Security” parameter of “Security Setting” is applied on this machine, various security functions are forcibly set in order to prevent unauthorized use of this machine and increase security when managing saved data. Restrictions are applied to user operations, and box operations and print jobs are limited.

There are various settings that must first be specified or are forcibly set in order for “Enhance Security” to be set to “ON”. Before setting “Enhance Security” to “ON”, check the settings for the security functions.



### Reminder

*Before specifying encryption settings, disconnect network cables other than the telephone cable from the machine.*

*If there are settings that are incompatible with “Enhance Security”, “Enhance Security” cannot be set to “ON”.*



### Note

*The settings that must be specified or are forcibly set cannot be changed after “Enhance Security” is set to “ON”.*

### Before specifying the “Enhance Security” parameter

The following settings must first be specified in order to set “Enhance Security” to “ON”.

Administrator Management screen	Settings
Admin. Set—Administrator Code Input	Specify a password that meets the password rules. If the specified password does not meet the password rules, “Enhance Security” can be set to “ON”; however, the password will be invalid when it is entered in the Administrator Management screen.
HDD Management—HDD Lock Setting	If the optional hard disk drive is installed, a 20-digit hard disk locking password will be specified.
Encryption Setting	If security kit SC-504 is installed, encryption is specified. Either a locking password or encryption must be specified.



### Note

*“HDD Management” appears in the Administrator Management screen only when the optional hard disk drive is installed.*

*Certain conditions must be met, for example, an SSL certificate must be registered, service codes must be changed and CS remote care must be canceled, in order for the enhanced security features to be applied. For details on registering an SSL certificate, refer to the User’s Guide [Network Scanner Operations]. For details on changing service codes and canceling CS remote care, contact your technical representative.*



### Detail

*For details on the password rules, refer to “Password rules” on page 11-70.*

*To cancel encryption settings, set “Enhance Security” to “OFF”, erase all data from the memory, and then turn the machine off, then on again with the main power switch to initialize it. For details on managing the hard disk, refer to the User’s Guide [Box Operations].*

## Parameters that are changed when “Enhance Security” is set

When “Enhance Security” is set to “ON”, settings for the following parameters are forcibly changed in order to enhance security. The changed parameters do not return to their original settings, even after “Enhance Security” is canceled. Before setting “Enhance Security” to “ON”, carefully check the parameters that are to be changed.

Changed parameters	Details of change
Password rules	Password rules are applied.
Access locks	This parameter is enabled. If the password for an operation requiring a password is incorrectly entered three consecutive times, the password can no longer be entered.
Software SW	The software switch settings cannot be changed.
Button display in the User Authentication screen	[User List] does not appear.
Allow Print without Authentication	This parameter cannot be used.
Auto Reset	This parameter cannot be set to “OFF”. If this parameter is set to “OFF” before “Enhance Security” is set to “ON”, this parameter will change to “1 min.”
Restrict One Touch Editing	“Restrict One Touch Editing” is set to “ON”.



Changed parameters	Details of change
Temporary overwrite data	“Temporary overwrite data” is set to “ON”.
Cancel HDD Locking Password	The hard disk locking password setting can no longer be changed.



### Detail

*For details on the password rules, refer to “Password rules” on page 11-70.*

*For details on the access locks, refer to “Canceling an access lock (“Unlock” parameter)” on page 11-66.*

*For details on the changed network settings, refer to the User’s Guide [Network Scanner Operations].*

*For details on the changed box settings, refer to the User’s Guide [Box Operations].*

*For details on the changed fax settings, refer to the User’s Guide [Facsimile Operations].*



### Note

*The following software cannot be used when the enhanced security features are applied.*

*HDD Backup Utility*

*HDD Twain*

*PageScope Box Operator*

*PageScope Data Administrator*

## Specifying the “Enhance Security” parameter

Settings can be specified to enhance security for using the machine.

- ✓ In order to set “Enhance Security” to “ON”, various conditions concerning the settings must be met. For details, refer to “Before specifying the “Enhance Security” parameter” on page 11-62.

- 1 Display the Admin. 2 screen, and then touch [Security Setting].
  - For details on displaying the Admin. 2 screen, refer to “Displaying the Administrator Management screen” on page 11-21.
 The Security Setting screen appears.

- 2 Touch [Enhance Security].

The Enhance Security screen appears.

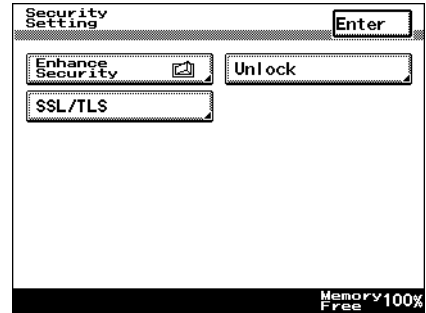

- 3 Touch [ON], and then touch [Enter].

- If the conditions for setting “Enhance Security” to “ON” have not been met, a message appears, indicating why the “Enhance Security” parameter cannot be used. In that case, follow the instructions provided in the message so that the “Enhance Security” parameter can be used.

The message “To enable the Encryption setting turn off the power switch and after a while turn it on. Please format HDD after turning on the power switch.” appears.

- 4 Turn the machine off with the main power switch, and then wait about 10 seconds before turning it on again.
  - The “Enhance Security” parameter should be turned off by the administrator. Select “OFF” in the Enhance Security screen, touch [Enter], and then perform the operation described in step 4.

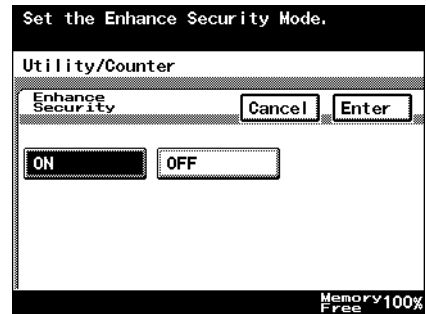

**Detail**

*When “Enhance Security” is set to “ON”, a password that does not meet the password rules cannot be used. For details, refer to “Password rules” on page 11-70.*

*When “Enhance Security” is set to “ON”, the software switch settings cannot be changed. In addition, the parameters that are changed when “Enhance Security” is set to “ON” do not return to their original settings, even after “Enhance Security” is set to “OFF”.*

**Canceling an access lock (“Unlock” parameter)**

Operations that the access lock is applied to are locked so that the password cannot be entered after it has been incorrectly entered three consecutive times. Restart the machine or, if the penalty is canceled, the password is no longer authenticated.

By canceling the penalty, certain operations are set so that the access lock does not apply to them and they can be unlocked.

The access lock applies to the following passwords. However, the administrator password cannot be set so that the access lock does not apply to it. passwords for confidential documents, box passwords, user authentication passwords, print management passwords, bulletin board F-code passwords, confidential box F-code passwords, and the administrator password

**Detail**

*As a default, the access lock is disabled.*

*The software switch settings can be used to enable the access lock. For details on the software switch settings, refer to “Specifying software switch settings (machine functions)” on page 11-50.*

*Even if the access lock was disabled with the software switch settings, it is enabled when “Enhance Security” is set to “ON”.*

**To cancel an access lock**

- 1** Display the Admin. 2 screen, and then touch [Security Setting].
  - For details on displaying the Admin. 2 screen, refer to “Displaying the Administrator Management screen” on page 11-21.
 The Security Setting screen appears.

- 2 Touch [Unlock].  
The Unlock screen appears.

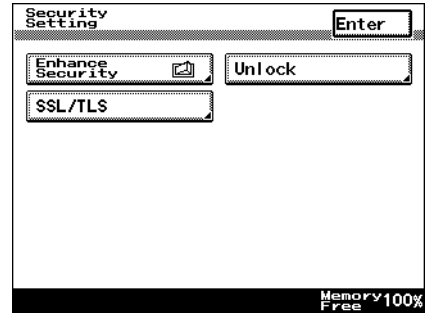

- 3 Select the button for the operation to be set so that the access lock is no longer applied, and then touch [Enter].

- If no options corresponding to the buttons are installed, no buttons appear. If users are not registered, [User Authentication] does not appear.

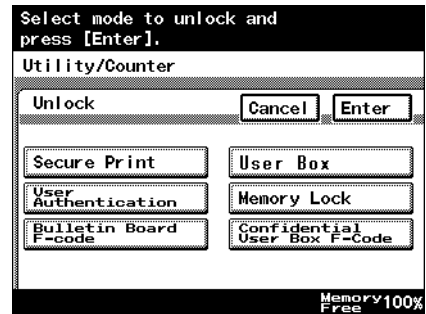

The Security Setting screen appears again.



#### Note

*If the password is not authenticated, even after the operation has been set so that the access lock is no longer applied, restart the machine.*

*The access lock can be canceled by turning the machine off, then on again with the main power switch.*

*When turning the machine off, then on again with the main power switch, wait about 10 seconds to turn the machine on after turning it off. The machine may not operate correctly if it is turned on immediately after being turned off.*

## 11.12 Managing the memory (Memory Management parameters)

Data stored on the internal memory can be erased, and all programmed and specified settings can be set to their defaults.



### Reminder

*Before managing the memory, disconnect network cables other than the telephone cable from the machine.*

*If the “Overwrite All Data” parameter on the Memory Management screen is selected, all programmed and specified settings are reset to their defaults. Therefore, the machine may not operate correctly after all data is overwritten. Overwrite all data when disposing of the machine. Do not perform this operation in any other circumstances.*

*Wait at least two minutes after turning on the machine before deleting all of the data.*

*Do not touch the machine while deleting all of the data in order to prevent errors from occurring.*



### Note

*The data on the memory cannot be erased while a job is being performed.*

### To erase all data from the internal memory

- 1 Display the Admin. 2 screen, and then touch [Memory Management].
  - For details on displaying the Admin. 2 screen, refer to “Displaying the Administrator Management screen” on page 11-21.
  - If the optional hard disk drive is installed, [HDD Management] appears instead of [Memory Management]. For details on the “HDD Management” parameter, refer to the User’s Guide [Box Operations].

The Memory Management screen appears.

- 2 Touch [Overwrite All Data].  
The Overwrite All Data screen appears.

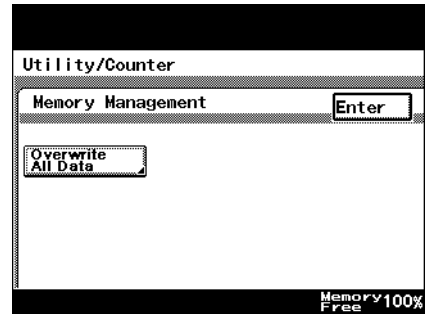

- 3 Touch [Yes], and then touch [Enter].  
Wait until the message "All data has been overwritten." appears.



### Note

*If a job is being performed, the message "Cannot start because there is an unfinished job." appears. Touch [Enter] to return to the previous screen, make sure that the job is completed, and then select the "Overwrite All Data" parameter again.*

*If the message "Failed to overwrite All Data. ..." appears, turn the machine off with the main power switch, wait about 10 seconds before turning it on again, and then select the "Overwrite All Data" parameter again.*

## 11.13 Password rules

When “Enhance Security” is set to “ON”, the password rules are applied, and the following limitations are applied to passwords in order to increase security.

Passwords that have already been specified, but do not meet the password rules when “Enhance Security” is set to “ON” are not accepted when they are entered. In that case, the administrator should temporarily turn off “Enhance Security”, then specify the passwords according to the following conditions.



### Detail

*As a default, the password rules are disabled.*

*The software switch settings can be used to enable the password rules. For details on the software switch settings, refer to “Specifying software switch settings (machine functions)” on page 11-50.*

*Even if the password rules were disabled with the software switch settings, they are enabled when “Enhance Security” is set to “ON”.*

Conditions of the password rules

Limitations on the number of characters	Limitations on registering/changing
8 alphanumeric characters <ul style="list-style-type: none"> <li>Only half-width characters can be entered for the administrator password.</li> <li>User authentication user passwords must contain 8 or more characters.</li> </ul>	The administrator access code for the administrator password must meet the password rules. A password that consists of the same letter or number being repeated, such as “00000000”, cannot be registered.

Passwords that the password rules apply to

Password	Operations that use passwords
Administrator password	Used when specifying Administrator Management settings.
Account track password	Used when logging on after account track settings have been specified.
Box password	For details on the box operations, refer to the User’s Guide [Box Operations].
Confidential document password	For details on confidential document operations, refer to the User’s Guide [Box Operations].
User authentication user password	Used when logging on after user authentication settings have been specified.

**Detail**

*When the password rules are applied, the characters that can be used and the number of digits in each password are limited.*

*Be sure that the administrator password that is specified is an administrator access code that meets the password rules. If Administrator mode is entered using an administrator password that does not meet the password rules and enhanced security features are applied, it will no longer be possible to enter Administrator mode. For details, contact your technical representative.*





---

# 12

## Appendix

## 12 Appendix

### 12.1 Entering text

This section contains details on using the keyboard that appears in the touch panel for typing in passwords and text to register one-touch recipients. The keypad can also be used to type in numbers.

The following procedure describes how to enter characters in the User Name screen when registering users for user authentication.

#### To type text

- In the keyboard that appeared, touch the button for the desired character.
  - Numbers can also be typed in with the keypad.
  - To type in uppercase letters, touch [Caps].
  - To cancel Caps mode, touch [Caps] again.

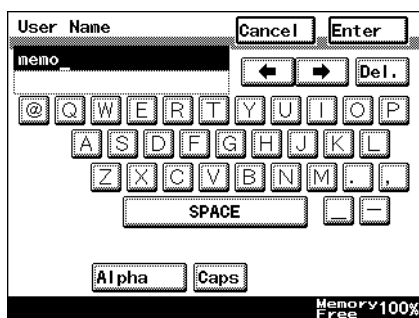



### Note



To cancel the entered text, touch [Cancel].

To clear all entered text, press the [C] (clear) key.



### Detail

To switch between entering letters or symbols, touch the button for switching the input mode.

To change a character in the entered text, touch  and  to move the cursor to the character to be changed, touch [Del.], and then type in the desired letter or number.

The software switch settings can be used to change how characters are deleted. For details on the software switch settings, refer to “Specifying software switch settings (machine functions)” on page 11-50.

If the number of characters exceeds the limit allowed, the last character is replaced with the last character entered.

### List of available characters

Alphanumeric characters / symbols	ABCDEFGHIJKLMNOPQRSTUVWXYZabcdefghijklmnopqrstuvwxyz [Space]!"#\$%&'()*+,-./:;<=>?@[ ]_{}*~0123456789
-----------------------------------	--

## 12.2 Glossary

Term	Definition
Simplex/Duplex	Select the setting to specify if the scanned document and the printed copy are printed on just one side or both sides.
Access lock	Operations that the access lock is applied to are locked so that the password cannot be entered after it has been incorrectly entered three consecutive times.
Accessibility	Specify these settings to set up and adjust the control panel and touch panel.
Account Track	Set this function to group users into accounts and manage their use of the machine (printing and scanning counts and number of prints).
ADF	Reverse automatic document feeder; Can be used to automatically scan the document
AMS	Auto Magnification Select; "Auto Zoom" setting
APS	"Auto Paper Select" setting
ATS	Automatic paper-tray-switching feature (ATS = Auto tray switch)
Automatic paper-tray-switching feature	If a paper tray runs out of paper while copies are being printed and the same size of paper is detected in a different paper tray, that paper tray is selected so that copying can continue.
Automatic panel reset	The machine automatically performs this operation to return all settings to their defaults if no operation is performed for the specified length of time.
Auto Paper Select	Select this setting to detect the document placed on the original glass or loaded into the ADF, then automatically select paper of the same size if "x1.0" is selected or select the paper size appropriate for the specified zoom ratio.
Auto Zoom	Select this setting to automatically select the appropriate zoom ratio after a document is placed on the original glass or loaded into the ADF and the copy paper size is selected.
B/W Reverse	Set this function to copy the document with the light- and dark-colored areas or the gradations of the image inverted.
Center Erase	Select this setting to print copies with the center (fold) of the document erased.
Change Tray Settings	Touch this button to specify a paper size not loaded in a paper tray or to copy on paper other than plain paper.
Chapters	Set this function to specify chapter title pages that must be printed on the front side of the paper when printing double-sided copies.
Combine Originals	Select a setting to arrange reduced copies of multiple document pages on a single copy page. The settings for the number of pages that can be combined are "2 in 1", "4 in 1" and "8 in 1".
Cover Mode	Set this function to add paper from the specified paper tray to the copies as a cover page.
Density	Select a setting to adjust the density of the print image to one of nine levels.
Edge/Frame Erase	Set this function to erase unwanted areas from the document, such as the shadows around the edges and the fold.

Term	Definition
Enhance Security	The various enhanced security features for preventing unauthorized use of this machine and for increasing security when managing saved data.
Enlarge Display	In this mode, the screens are displayed larger for easier operation.
Erase	Set this function to erase the unwanted parts of the document image.
Finisher	This unit sorts and finishes copies that have been fed out.
Fold & Staple	Set this function to fold the copies in half and staple them together at the center.
Folding	Select the folding setting to specify how copies are folded. Depending on the finisher and other options that are installed, the "Crease" and "Center Binding" settings are available.
Group	Select this setting to separate the copies of each page in the document. The specified number of copies of the second page is printed after all copies of the first page are finished. Select this setting to separate copies that are fed out.
Image Repeat	Set this function to repeatedly print the image scanned from the document to fill the entire page
Image Settings	Set the appropriate function to make copies with the desired image added. Set the "Set Numbering" function to print copies with a distribution number in the background. Set the "Stamp" function to print copies with one of the preset stamps, such as "TOP SECRET", "COPY" or "PROOF". Set the "Image Overlay" function to print copies overlapping a different scanned image.
Insert Image	Set this function to later scan multiple images from the original glass and insert them at the desired locations in a document scanned with the ADF, then feed out all copies together.
Insert Sheet	Set this function to insert paper from the specified paper tray into the copies as chapter title pages.
Job	The copy operation that is queued on the machine while copying; Multiple jobs can be queued on the machine.
LCT	Optional paper feed cabinet that can be loaded with up to 2,500 sheets of paper.
Low Power Mode	The machine automatically enters this mode, where it conserves energy, if no operation is performed for the specified length of time. In this mode, the touch panel go off.
Margin	Select the setting for the position of the binding margin for the loaded document. Selecting the appropriate setting prevents the copy from being printed upside-down when making double-sided copies from single-sided documents or when making single-sided copies from double-sided documents.
Memory Scan	Scans a document exceeding the maximum 80 pages that can be loaded into the ADF by scanning the document in separate batches. The document can be scanned and treated as a single copy job. In addition, the scanning location can be switched between the original glass and the ADF during the scanning operation.

Term	Definition
Minimal	Select this setting to produce a copy with the original image slightly reduced.
Mixed Original	Select this setting to detect the size of each document page and print a copy on paper of the appropriate size when a document with different page sizes is loaded together into the ADF.
Offset	Select this setting to separate copies that are fed out.
OHP Interleave	Set this function to insert paper between overhead projector transparencies that are being copied. This prevents overhead projector transparencies from sticking together.
Paper	Select settings for the type and size of paper to be printed on.
Password rules	Strict conditions for limiting passwords, for example, passwords consisting of the same character repeated cannot be specified and passwords must contain 8 or more characters.
Proof Copy	Press this key to print a single sample copy and stop the machine so that it can be checked before printing a large number of copies. This prevents copy errors from occurring in a large number of copies.
Punch	Select the setting to punch holes in the copies for filing.
Quality	Select the setting for the image type of the document to better adjust the copy quality.
Sheet/Cover/Chapter Insert	Select from the functions that are available to edit copies as desired.
Sleep Mode	The machine automatically enters this mode, where it conserves energy, if no operation is performed for the specified length of time. The machine conserves more energy in this mode than in Low Power mode.
Sort	Select this setting to separate each set of the copies. The second copy set is printed after all of the first copy set is finished.
User Authentication	Set this function to manage individual users access to the machine. With machine authentication, the number of prints and scans are counted for each user. With external server authentication, limitations can be placed on user access.
XY Zoom	Touch this button to use the keypad to specify the zoom ratio for producing an enlarged/reduced copy of the loaded document.
Zoom	Specify the zoom ratio of the copy.

## 12.3 Index

### Symbols

- [Power] (auxiliary power key) ..... 2-22  
 ×1.0 setting ..... 3-29

### Numerics

- 1st tray ..... 2-54  
 2 in 1 ..... 3-47  
 2 staples setting ..... 3-52  
 2nd tray ..... 2-54  
 4 in 1 ..... 3-48

### A

- Access lock ..... 11-57  
 Accessibility ..... 4-14  
 Account data ..... 11-31  
 Account track ..... 2-37, 11-27, 11-31  
 Access lock ..... 11-66  
 ADF ..... 3-8, 7-17  
 Admin. set. .... 11-25  
 Administrator management ..... 11-21  
 Authentication ..... 2-30, 2-50  
 Authentication form ..... 11-27  
 Auto paper select setting ..... 3-24  
 Auto zoom setting ..... 3-27  
 Automatic duplex unit ..... 6-4  
 Automatic panel reset ..... 2-27  
 Automatic paper-tray-switching  
 feature ..... 7-7

### B

- B/W reverse setting ..... 8-35  
 Basics screen ..... 2-17  
 Book copy function ..... 8-18  
 Booklet function ..... 8-22  
 Bypass tray ..... 2-60

### C

- Call technical representative ..... 5-2  
 Center binding ..... 3-52  
 Cleaning ..... 10-2  
 Combine originals settings  
 ..... 3-46, 3-49  
 Contrast ..... 3-43, 3-45  
 Control panel ..... 2-14, 2-20  
 Copy programs ..... 4-8  
 Corner staple setting ..... 3-52  
 Counters ..... 10-6  
 Cover mode function ..... 8-2

### D

- Default settings ..... 11-23  
 Document feeding ..... 3-8  
 Document orientation ..... x-27  
 Documents ..... 7-17  
 Double-sided copies ..... 3-41

### E

- Edge/Frame erase function ..... 8-13  
 Energy star ..... x-1  
 Enhance security ..... 11-57, 11-62  
 Enlarge display ..... 2-19  
 Enlarge/Reduce settings ..... 3-32  
 External server authentication  
 ..... 2-33, 11-38

### F

- Finisher FS-530 ..... 2-12, 6-7  
 Finishing settings ..... 3-50

### G

- Group setting ..... 3-51, 3-54

### H

- Hole-punch setting ..... 3-57



- I**
- Icons ..... 2-18
  - Image overlay function ..... 8-28
  - Image repeat function ..... 8-15
  - Image settings functions ..... 8-24
  - Individual zoom settings ..... 3-34
  - Insert sheet function ..... 8-5
  - Interrupt ..... 4-7
- J**
- Job list ..... 4-21
  - Job separator JS-502 ..... 6-9
- L**
- Labels
    - Caution notations and labels ... 1-16
  - LCD back-light off ..... 2-29
  - LCT ..... 2-57
  - Legal restrictions on copying ..... x-29
  - Low power mode ..... 2-28
- M**
- Machine authentication
    - ..... 2-30, 2-50, 11-38
  - Mailbin kit MT-502 ..... 2-11, 6-9
  - Main power switch ..... 2-22
  - Margin settings ..... 3-21, 8-11
  - Memory management ..... 11-68
  - Messages ..... 5-34
  - Minimal setting ..... 3-30
  - Mixed original setting ..... 3-16
  - Mode memory ..... 4-8
- N**
- Non-sort setting ..... 3-50
- O**
- OHP interleave function ..... 8-8
  - Operating environment ..... 1-18
  - Options ..... 2-2
  - Original direction settings ..... 3-19
  - Original glass ..... 3-10, 7-19
  - Output tray OT-602 ..... 2-12, 6-8
- P**
- Paper ..... 2-54, 2-57, 2-60
  - Paper capacity ..... 7-4
  - Paper feed cabinet PC-108 ... 2-10, 6-5
  - Paper feed cabinet PC-206 ... 2-10, 6-6
  - Paper feed cabinet PC-407 ... 2-10, 6-6
  - Paper misfeed ..... 5-4, 5-5
  - Paper settings ..... 7-8
  - Paper sizes ..... 7-2
  - Paper storage ..... 7-6
  - Paper types ..... 7-4
  - Part names ..... 2-2
  - Password rule ..... 11-57, 11-62, 11-70
  - Periodic maintenance ..... 10-7
  - Power source ..... 1-18
  - Programs ..... 4-8
  - Proof copy ..... 4-5
  - Punch unit PU-501 ..... 2-12, 6-8
  - Punch waste container ..... 9-24
  - Punched holes ..... 3-52
- Q**
- Quality ..... 3-43
  - Queuing copy jobs ..... 3-61
- R**
- Replacing staple cartridge ..... 9-7
  - Replacing toner bottle ..... 9-2, 9-4
  - Reverse automatic document feeder
    - DF-620 ..... 2-9, 6-4
- S**
- Saddle stitcher SD-507 ..... 2-11, 6-8
  - Safety information ..... 1-2

Separate scan setting .....	3-12, 8-36
Set numbering function .....	8-24
Set zoom .....	3-37
Settings .....	4-2
Simplex/duplex .....	3-39
Single-sided copies .....	3-40
Sleep .....	2-28
Software switch settings .....	11-50
Sort setting .....	3-51, 3-53
Space requirements .....	1-17
Special paper .....	7-5, 7-15
Stamp function .....	8-24
Staple jam .....	9-15
Stapling .....	3-52, 3-55

## T

Troubleshooting .....	5-30
-----------------------	------

## U

User authentication .....	11-27, 11-38
User choice settings .....	11-9
User management settings .....	11-19
Utility mode .....	11-2

## W

Warm up .....	2-24
---------------	------

## Z

Zoom settings .....	3-27
---------------------	------





**KONICA MINOLTA**

<http://konicaminolta.com>