

bizhub 751/601

User's Guide [Copy Operations]

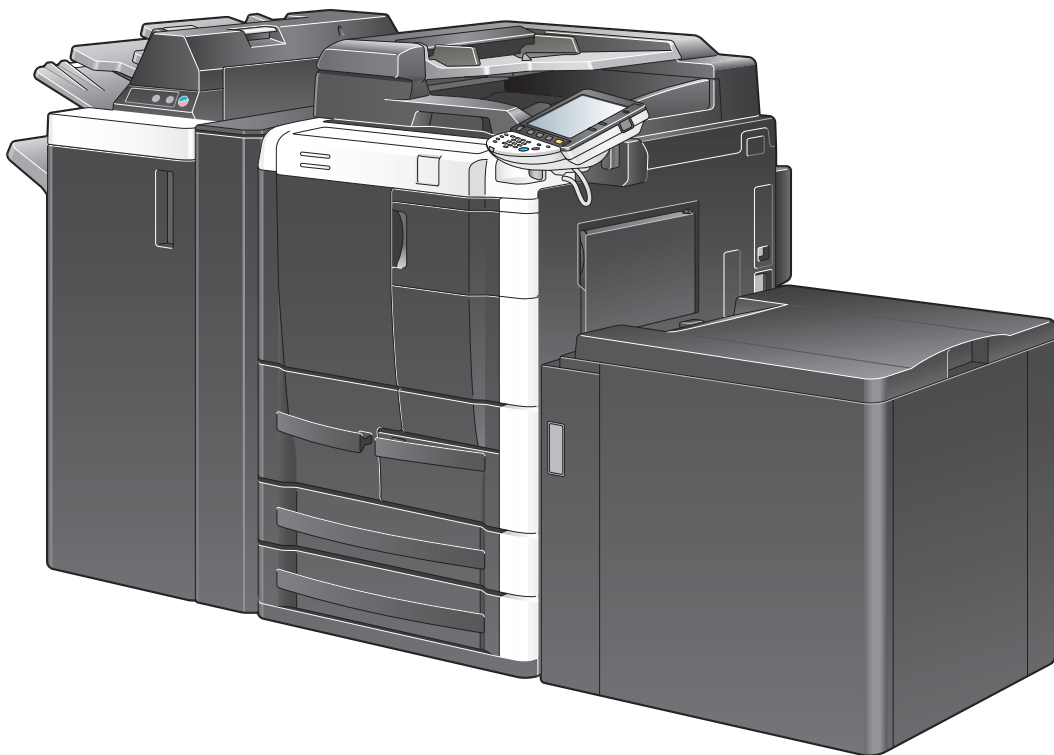



Introduction

Thank you for choosing this machine.

This manual contains details on the operation of the various functions of the machine, precautions on its use, and basic troubleshooting procedures. In order to ensure that this machine is used correctly and efficiently, carefully read this manual as needed.

For descriptions on trademarks and copyrights, refer to [Trademarks/Copyrights].

The illustrations used in this manual may appear slightly different from views of the actual equipment.

1 Before Making Copies

1.1	Machine Configuration	1-2
1.1.1	Options	1-2
1.1.2	External.....	1-4
1.1.3	Internal.....	1-7
1.1.4	Large Capacity Unit LU-405.....	1-9
1.1.5	Large Capacity Unit LU-406.....	1-10
1.1.6	Finisher FS-524/Punch Kit PK-505.....	1-11
1.1.7	Finisher FS-525/Punch Kit PK-505.....	1-13
1.1.8	Finisher FS-610/Punch Kit PK-505.....	1-15
1.1.9	Z Folding Unit ZU-605	1-18
1.1.10	Post Inserter PI-504.....	1-19
1.1.11	Shift Tray SF-602.....	1-20
1.1.12	Output Tray OT-505.....	1-21
1.1.13	Authentication Unit (Biometric Type) AU-101.....	1-21
1.1.14	Authentication Unit (IC Card Type) AU-201.....	1-22
1.1.15	Control panel	1-22
1.1.16	Basic settings screens.....	1-24
1.1.17	Icons that appear in the screen	1-26
1.2	Adjusting the angle of the control panel	1-27
1.2.1	To adjust the angle of the control panel.....	1-27
1.3	Turning on the main power and the auxiliary power	1-29
1.3.1	Turning on the machine.....	1-29
1.3.2	Scanning during warm-up	1-30
1.3.3	Turning off the machine.....	1-31
1.3.4	Automatically clearing settings (automatic panel reset)	1-31
1.3.5	Automatically canceling the mode screen (System Auto Reset).....	1-32
1.3.6	Automatically conserving energy (Low Power mode).....	1-32
1.3.7	Automatically conserving energy (Sleep mode)	1-33
1.3.8	Manually conserving energy.....	1-33
1.3.9	Automatically turning the machine on/off (Weekly Timer)	1-34
1.3.10	Controlling each user's use of this machine (User Authentication).....	1-35
1.3.11	Controlling each account's use of this machine (Account Track)	1-38
1.3.12	Controlling use of this machine with authentication unit (biometric type).....	1-41
1.3.13	Controlling use of this machine with the authentication unit (IC card type)	1-44
1.4	Loading paper into the tray 1 or 2	1-47
1.5	Loading paper into the tray 3 or 4	1-48
1.6	Loading paper into the LCT (LU-405/LU-406)	1-50
1.7	Loading paper into the bypass tray	1-53
1.8	Loading paper of a different size into paper trays	1-57
1.8.1	Changing the size of paper that is loaded.....	1-57
1.8.2	When 5-1/2 × 8-1/2 or A5-size thick paper is loaded into a paper tray	1-58

2 Basic copy operations

2.1	General copy operation	2-2
2.2	Operations that cannot be combined	2-4
2.2.1	Operations where the setting specified last is given priority.....	2-4
2.2.2	Operations where the setting specified first is given priority.....	2-5
2.3	Feeding the original	2-6
2.3.1	Loading the original into the ADF	2-6
2.3.2	Placing the original on the original glass	2-7
2.3.3	Scanning the original in separate batches ("Separate Scan" setting).....	2-8

2.3.4	Scanning a multi-page original from the original glass	2-11
2.4	Specifying original settings	2-16
2.4.1	Specifying the original size (Original Size settings)	2-16
2.4.2	Copying originals of mixed sizes ("Mixed Original" setting)	2-18
2.4.3	Loading folded (Z-folded) originals.....	2-20
2.4.4	Loading tab paper (Tab Original settings)	2-21
2.4.5	Selecting the original orientation (Original Direction settings).....	2-22
2.4.6	To select an Original Direction setting.....	2-23
2.4.7	Selecting the position of the binding margin ("Binding Position" settings).....	2-24
2.4.8	To select a Binding Position setting	2-25
2.4.9	Changing scan settings for each original	2-26
2.5	Selecting a Paper Setting	2-30
2.5.1	Automatically selecting the paper size ("Auto" Paper setting)	2-30
2.5.2	Manually selecting the desired paper size	2-31
2.6	Specifying a Zoom setting	2-32
2.6.1	Automatically selecting the zoom ratio ("Auto" Zoom Setting)	2-32
2.6.2	Specifying the zoom ratio of the original ("Full Size" setting).....	2-33
2.6.3	Typing in the zoom ratio (XY Zoom setting)	2-33
2.6.4	Slightly reducing the copy ("Minimal" setting).....	2-35
2.6.5	Selecting a preset zoom ratio (Enlarge and Reduce settings).....	2-36
2.6.6	Typing in separate X and Y zoom ratios (Individual Zoom settings).....	2-37
2.6.7	Selecting a stored zoom ratio.....	2-39
2.6.8	Storing the desired zoom ratio	2-40
2.7	Selecting an Original > Copy setting	2-42
2.7.1	Selecting single-sided copies.....	2-43
2.7.2	Selecting double-sided copies.....	2-44
2.8	Selecting a combined copy setting.....	2-47
2.8.1	Copying multiple original pages onto a single page (combined copy settings).....	2-48
2.9	Selecting the quality of the original	2-50
2.9.1	Loading originals with small print or photos ("Original Type" settings).....	2-50
2.9.2	To select an Original Type setting	2-50
2.10	Selecting the Density settings.....	2-52
2.10.1	Adjusting the print density (Density settings)	2-52
2.10.2	Adjusting the background density (Background Removal settings).....	2-53
2.11	Selecting Finishing settings.....	2-54
2.11.1	Separating copies by sets ("Sort" setting).....	2-56
2.11.2	Separating copies by pages ("Group" Setting)	2-56
2.11.3	Selecting the output tray	2-58
2.11.4	Outputting copies with their front sides facing up (Face Up settings)	2-59
2.11.5	Stapling copies (Staple settings)	2-60
2.11.6	Punching holes in copies (Punch settings).....	2-62
2.12	Selecting a folding setting	2-65
2.12.1	Folding copies in half ("Half-Fold" setting)	2-65
2.12.2	Binding copies at the center ("Center Staple & Fold" setting)	2-67
2.12.3	To fold copies in three ("Tri-Fold" setting).....	2-68
2.12.4	Z-Folding and outputting papers ("Z-Fold" setting)	2-70
2.13	Manually using the finisher	2-73
2.14	Selecting not to rotate the image.....	2-76
2.15	Scanning the next original to be copied while a copy job is being printed (next job reservation).....	2-77
2.16	Temporarily stopping scanning/printing	2-78
2.17	Deleting a paused job.....	2-79



3 Additional copy operations

3.1	Checking the Copy Settings (Check Job)	3-2
3.1.1	To check the settings	3-2
3.1.2	To change the settings	3-4
3.2	Printing a proof to check the settings (Proof Copy)	3-5
3.3	Interrupting a copy job (Interrupt mode)	3-7
3.4	Registering copy programs (Mode Memory)	3-8
3.4.1	Deleting a copy program	3-10
3.5	Copying with programmed copy settings (Mode Memory)	3-11
3.6	Displaying function descriptions (Help)	3-13
3.6.1	Overview of Help screens.....	3-13
3.6.2	Displaying main Help screens	3-15
3.7	Specifying control panel settings (Accessibility mode)	3-18
3.7.1	Displaying the Accessibility Setting screen	3-18
3.7.2	Setting the "Touch Panel Adjustment" function	3-18
3.7.3	Setting the Key Repeat Start/Interval Time functions	3-19
3.7.4	Setting the "System Auto Reset Confirmation" function.....	3-21
3.7.5	Setting the "Auto Reset Confirmation" function.....	3-22
3.7.6	Setting the "Enlarge Display Mode Confirmation" function	3-24
3.7.7	Setting the "Message Display Time" function	3-26
3.7.8	Setting the "Sound Setting" functions.....	3-27

4 Troubleshooting

4.1	When an error code appears	4-2
4.2	When the message "misfeed detected." appears	4-4
4.2.1	Location of paper misfeed and illustration	4-4
4.2.2	Paper misfeed indications	4-5
4.2.3	Cleaning a paper misfeed in tray 1 "1"	4-6
4.2.4	Cleaning a paper misfeed in tray 2 "2"	4-9
4.2.5	Cleaning a paper misfeed in tray 3 and tray 4 "3" "4"	4-11
4.2.6	Cleaning a paper misfeed in the LCT (Large Capacity Unit)"5"	4-13
4.2.7	Cleaning a paper misfeed in the bypass tray "6"	4-14
4.2.8	Cleaning a paper misfeed in the vertical transport section "7"	4-15
4.2.9	Cleaning a paper misfeed in the ADU unit "8"	4-15
4.2.10	Cleaning a paper misfeed in the ADU unit "9"	4-17
4.2.11	Cleaning a paper misfeed in the ADU unit "10"	4-19
4.2.12	Cleaning a paper misfeed in the ADU unit "11"	4-20
4.2.13	Cleaning a paper misfeed in the ADU unit "12"	4-22
4.2.14	Cleaning a paper misfeed in the ADU unit "13"	4-24
4.2.15	Cleaning a paper misfeed in the ADF "14"	4-25
4.2.16	Cleaning a paper misfeed in the ADF "15"	4-26
4.2.17	Cleaning a paper misfeed in Finisher FS-524/FS-525 "16" "18"	4-28
4.2.18	Cleaning a paper misfeed in Finisher FS-610 "16" "18"	4-32
4.2.19	Cleaning a paper misfeed in the shift tray "16"	4-38
4.2.20	Cleaning a paper misfeed in the post inserter "17"	4-38
4.2.21	Cleaning a paper misfeed in the Z folding unit "20"	4-39
4.3	Simple troubleshooting	4-43
4.4	Main messages and their remedies	4-47

5 Specifications

5.1	Specifications	5-2
5.1.1	Main unit	5-2
5.1.2	Automatic Document Feeder DF-614.....	5-3

5.2	Option Specifications	5-4
5.2.1	Large Capacity Unit LU-405	5-4
5.2.2	Large Capacity Unit LU-406	5-4
5.2.3	Finisher FS-524	5-4
5.2.4	Finisher FS-525	5-5
5.2.5	Finisher FS-610	5-6
5.2.6	Punch Kit PK-505	5-7
5.2.7	Z Folding Unit ZU-605	5-8
5.2.8	Post Inserter PI-504.....	5-8
5.2.9	Shift Tray SF-602.....	5-9
5.2.10	Output Tray OT-505.....	5-9
5.2.11	Authentication Unit (Biometric Type) AU-101.....	5-10
5.2.12	Authentication Unit (IC Card Type) AU-201.....	5-10
5.2.13	Other Options	5-11

6 Copy paper/originals

6.1	Copy paper	6-2
6.1.1	Paper Tray and Equipment.....	6-2
6.1.2	Paper Weight	6-2
6.1.3	Paper Tray/ Output Tray Capacity.....	6-3
6.1.4	Paper Size.....	6-4
6.1.5	Special Paper	6-6
6.1.6	Precautions for paper	6-7
6.1.7	Paper storage	6-7
6.1.8	Auto Tray Switch Function	6-8
6.2	Selecting the Paper settings for bypass tray	6-9
6.2.1	Automatically detecting the paper size ("Auto Detect" setting).....	6-9
6.2.2	Selecting a paper size setting (Size Setting)	6-10
6.2.3	Specifying a non-standard paper size (Custom Size settings).....	6-12
6.2.4	Storing a non-standard paper size (Custom Size settings).....	6-14
6.2.5	Selecting a setting for oversized paper (Wide Paper settings).....	6-16
6.2.6	Specifying a paper type for bypass tray.....	6-18
6.3	Paper type setting for a tray	6-20
6.3.1	To display the Paper Tray Setting screen.....	6-20
6.3.2	To specify a standard size paper (Standard Size 1 settings)	6-21
6.3.3	To specify a setting for standard special-sized paper (Special Size settings)	6-22
6.3.4	To specify a non-standard paper size (Custom Size settings)	6-24
6.3.5	To select a setting for oversized paper	6-25
6.3.6	Specifying a paper type.....	6-26
6.4	Originals	6-29
6.4.1	Originals that can be loaded into the ADF.....	6-29
6.4.2	Precautions for loading originals into the ADF	6-30
6.4.3	Originals that can be loaded on the original glass	6-30

7 Application functions

7.1	Inserting paper between OHP transparencies ("OHP Interleave" function)	7-2
7.2	Adding cover pages ("Cover Sheet" function)	7-5
7.3	Inserting different paper into copies ("Insert Sheet" function)	7-8
7.4	Inserting copies of a different original for a specified page ("Insert Image" function)	7-12
7.5	Specifying pages to be printed on the front side ("Chapters" function)	7-15
7.6	Scanning originals with different settings and printing copies all together ("Program Jobs" function)	7-18
7.7	Reversing black-and-white gradation of the original ("Neg./Pos. Reverse" function)	7-22
7.8	Producing separate copies of each page in a page spread ("Book Copy" function)	7-24
7.9	Tiling copy images ("Image Repeat" function)	7-29

7.10	Dividing Spread Image into Right and Left Pages using ADF ("Page Separation" function)	7-33
7.11	Adding a binding margin to copies ("Page Margin" function).....	7-36
7.12	Adjusting the image to fit the paper ("Image Adjust" settings).....	7-39
7.13	Copying with the page layout of a booklet ("Booklet" function).....	7-42
7.14	Erasing specified area of copies (Erase)	7-45
7.14.1	Erasing black marks along borders ("Erase" function).....	7-46
7.14.2	Erasing black marks along center fold ("Center Erase" function).....	7-47
7.14.3	Erasing outside areas of the original ("Non-Image Area Erase" function).....	7-50
7.15	Printing the date/time or page number on copies (Stamp/Composition functions)	7-51
7.15.1	Printing the date/time ("Date/Time" function).....	7-52
7.15.2	Printing the page number ("Page Number" function).....	7-55
7.15.3	Printing previously registered stamps ("Stamp" function).....	7-58
7.15.4	Printing repeating stamps ("Stamp Repeat" function)	7-61
7.15.5	Printing the image scanned first overlapped by the remaining original pages ("Overlay" function)	7-65
7.15.6	Saving a scanned image as a registered overlay ("Registered Overlay" function).....	7-67
7.15.7	Using a registered overlay ("Registered Overlay" function).....	7-70
7.15.8	Printing a header/footer ("Header/Footer" function).....	7-71
7.15.9	Printing the distribution control number ("Distribution Control Number" function).....	7-73
7.15.10	Printing the watermark onto copies ("Watermark" function).....	7-75
7.16	Saving the scanned original in a user box ("Save in User Box" function).....	7-77

8 Replacing toner cartridges and staple cartridges and emptying hole-punch scrap box

8.1	Replacing the toner cartridge.....	8-2
8.1.1	To replace the toner cartridge	8-3
8.2	Replacing the staple cartridge	8-6
8.2.1	To replace the staple cartridge in Finisher FS-524.....	8-7
8.2.2	To replace the staple cartridge in Finisher FS-525.....	8-11
8.2.3	To replace the staple cartridge in Finisher FS-610.....	8-15
8.3	Emptying hole-punch scrap boxes	8-18
8.3.1	To empty the hole-punch scrap box of the finisher	8-19
8.3.2	To empty the hole-punch scrap box of the Z folding unit	8-20

9 Care of the machine

9.1	Cleaning.....	9-2
9.1.1	Cleaning the left partition glass	9-2
9.1.2	Cleaning the original glass.....	9-2
9.1.3	Cleaning the document pad	9-2
9.1.4	Cleaning the paper take-up roller	9-3
9.1.5	Cleaning the main unit	9-3
9.1.6	Cleaning the control panel.....	9-3
9.1.7	Care of Authentication Unit (Biometric Type) AU-101	9-4
9.1.8	Care of Authentication Unit (IC Card Type) AU-201	9-4
9.2	Viewing counters (Meter Count).....	9-6
9.2.1	Viewing counters	9-6
9.3	When the message "It is time for the scheduled inspection of the device." appears	9-7

10 Managing jobs

10.1	Overview of Job List screen	10-2
10.1.1	Jobs	10-2
10.1.2	Multi-job feature	10-2
10.1.3	Job List screens	10-3
10.1.4	Left panel Job List	10-5

10.2	Performing operations on jobs	10-6
10.2.1	Deleting a job.....	10-6
10.2.2	Checking job settings.....	10-7
10.2.3	Checking job details.....	10-8
10.2.4	Displaying the Current Jobs list (stored jobs and active jobs).....	10-9
10.2.5	Displaying the Job History list.....	10-9
10.2.6	Printing a proof copy of a stored job.....	10-11
10.2.7	Printing a stored job.....	10-12
10.2.8	Increasing printing priority.....	10-14

11 Utility mode

11.1	Overview of Utility mode parameters	11-2
11.1.1	List of registration information and parameters.....	11-2
11.2	Registering a destination	11-7
11.2.1	Create One-Touch Destination.....	11-7
11.2.2	Create User Box.....	11-7
11.2.3	Limiting Access to Destinations.....	11-7
11.2.4	Displaying the destination registration screen.....	11-13
11.3	Specifying user settings	11-15
11.3.1	System Settings.....	11-15
11.3.2	Custom Display Settings.....	11-17
11.3.3	Copier Settings.....	11-18
11.3.4	Scan/Fax Settings.....	11-20
11.3.5	Printer Settings.....	11-20
11.3.6	Change Password.....	11-20
11.3.7	Change E-Mail Address.....	11-21
11.3.8	Toner Supply.....	11-21
11.3.9	Displaying the User Settings screen.....	11-21
11.4	Specifying administrator settings	11-23
11.4.1	System Settings.....	11-23
11.4.2	Administrator/Machine Settings.....	11-28
11.4.3	One-Touch/User Box Registration.....	11-29
11.4.4	User Authentication/Account Track.....	11-29
11.4.5	Network Settings.....	11-31
11.4.6	Copier Setting.....	11-32
11.4.7	Printer Settings.....	11-32
11.4.8	Fax Settings.....	11-33
11.4.9	System Connection.....	11-33
11.4.10	Security Settings.....	11-33
11.4.11	Displaying the Administrator Settings screen.....	11-36
11.5	Overview of weekly timer settings	11-38
11.6	Finisher Adjustment	11-39
11.6.1	Center Staple Position Adjustment.....	11-39
11.6.2	Half-Fold Position.....	11-40
11.6.3	Punch Vertical Position Adjustment.....	11-42
11.6.4	Punch Unit Vertical Position Adjustment.....	11-44
11.6.5	Punch Horizontal Position Adjustment.....	11-45
11.6.6	Punch Unit Horizontal Position Adjustment.....	11-47
11.6.7	Punch Resist Loop Size Adjustment.....	11-48
11.6.8	1st Z-Fold Position Adjustment/2nd Z-Fold Position Adjustment.....	11-49
11.6.9	Tri-Fold Position Adjustment.....	11-51
11.6.10	2-Position Staple Pitch Adjustment.....	11-53
11.6.11	Post Inserter Tray Size Adjustment.....	11-54
11.7	Header/Footer Settings	11-56
11.7.1	Specifying headers/footers.....	11-56

11.7.2	Editing headers/footers	11-58
11.8	Authentication Method.....	11-59
11.8.1	User authentication and account track	11-59
11.8.2	When user authentication and account track are synchronized	11-59
11.8.3	When user authentication and account track are used separately	11-60
11.8.4	Selecting an authentication method.....	11-60
11.9	User Authentication Setting.....	11-64
11.9.1	Administrative Settings—List	11-64
11.9.2	Default Function Permission.....	11-65
11.9.3	Public User Access.....	11-66
11.9.4	User Registration	11-66
11.9.5	User Counter	11-70
11.9.6	Viewing user counters	11-71
11.10	Account Track Setting.....	11-72
11.10.1	Account Track Registration	11-72
11.10.2	Account Track Counter.....	11-74
11.10.3	Viewing account counters	11-75
11.11	Password Rules	11-76
11.11.1	Conditions of the password rules.....	11-76
11.12	Enhanced Security Mode	11-78

12 Authentication Unit (Biometric Type AU-101)

12.1	Using Authentication Unit (Biometric Type) AU-101	12-2
12.1.1	Settings of this machine	12-2
12.1.2	Registering users	12-4
12.1.3	Logging on to this machine	12-16
12.1.4	Touch & Print function	12-17

13 Authentication Unit (IC Card Type AU-201)

13.1	Using Authentication Unit (IC Card Type) AU-201	13-2
13.1.1	Settings of this machine	13-2
13.1.2	Registering users	13-4
13.1.3	Logging on to this machine	13-16
13.1.4	Touch & Print function	13-18

14 Appendix

14.1	Entering text	14-2
14.1.1	Enlarging the keyboard.....	14-3
14.1.2	To type text.....	14-4
14.1.3	List of Available Characters.....	14-4
14.2	Glossary.....	14-5

15 Index

15.1	Index	15-2
-------------	--------------------	-------------

Available features

Automatically selecting the paper

The most appropriate paper size can automatically be selected based on the size of the loaded original and the specified zoom ratio.

For details, refer to ["Automatically selecting the paper size \("Auto" Paper setting\)" on page 2-30.](#)

Adjusting copies to the size of the paper

The most appropriate zoom ratio can automatically be selected based on the size of the loaded original and the specified paper size.

For details, refer to ["Automatically selecting the zoom ratio \("Auto" Zoom Setting\)" on page 2-32.](#)

Specifying separate horizontal and vertical zoom ratios

By specifying separate horizontal and vertical zoom ratios, copies of the original can be resized as desired.

For details, refer to ["Typing in separate X and Y zoom ratios \(Individual Zoom settings\)" on page 2-37.](#)

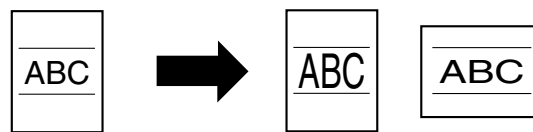

Scanning the original in separate batches

An original with a large number of pages can be divided and scanned in separate batches. Double-sided copies can be produced by using the original glass or the original pages can be alternately loaded onto the original glass or into the ADF, and then all pages can be copied together as a single job.

For details, refer to ["Scanning the original in separate batches \("Separate Scan" setting\)" on page 2-8](#) and ["Scanning a multi-page original from the original glass" on page 2-11.](#)

Carrying out half-fold/center staple & fold/tri-fold/Z-fold finishing process

Copies can be folded at their center ("Half-Fold" setting) or bound with staples after being folded in half ("Center Staple & Fold" setting). In addition, the copies can be folded in three ("Tri-fold" setting) or Z-folded ("Z-fold" setting).

For details, refer to ["Selecting a folding setting" on page 2-65.](#)

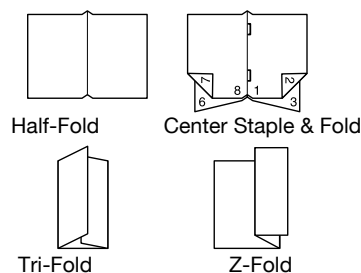

Sorting copies

The finishing method for copies can be selected.

For details, refer to ["Separating copies by sets \("Sort" setting\)" on page 2-56,](#) ["Separating copies by pages \("Group" Setting\)" on page 2-56.](#)

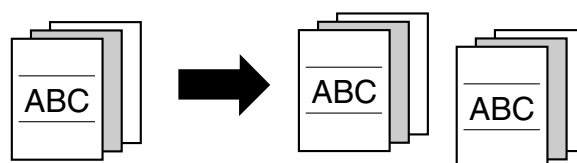

Stapling copies

Multi-page originals can be copied and stapled together.

For details, refer to ["Stapling copies \(Staple settings\)" on page 2-60](#).

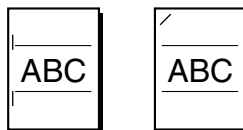

Punching holes in copies

Holes for filing can be punched in the copies.

For details, refer to ["Punching holes in copies \(Punch settings\)" on page 2-62](#).

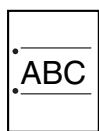

Copying multiple original pages onto a single page

Multiple pages of the original can be printed together on a single page.

For details, refer to ["Copying multiple original pages onto a single page \(combined copy settings\)" on page 2-48](#).



Copying an original containing various page sizes

An original with various page sizes can be scanned and copied together.

For details, refer to ["Copying originals of mixed sizes \("Mixed Original" setting\)" on page 2-18](#).

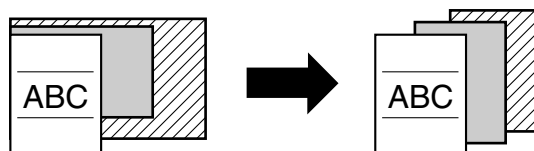

Adjusting copies according to the image quality of the original

The copies can be adjusted according to the image quality of the original.

For details, refer to ["Loading originals with small print or photos \("Original Type" settings\)" on page 2-50](#).

Inserting paper between copies of OHP

In order to prevent OHP from becoming stuck to each other, a page (interleaf) can be inserted between the transparency copies.

For details, refer to ["Inserting paper between OHP transparencies \("OHP Interleave" function\)" on page 7-2](#).

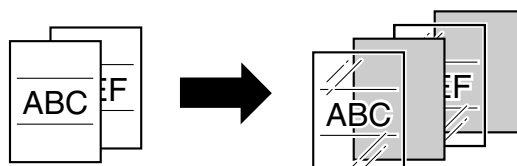

Adding a cover page

Cover pages can be added to copies, or copies can be made using different paper (for example, colored paper) for only the cover pages.

For details, refer to ["Adding cover pages \("Cover Sheet" function\)" on page 7-5.](#)

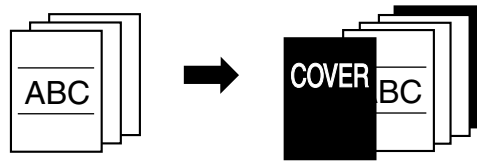

Inserting different paper into copies

Different paper (such as colored paper) can be inserted for specified pages in the copies.

For details, refer to ["Inserting different paper into copies \("Insert Sheet" function\)" on page 7-8.](#)

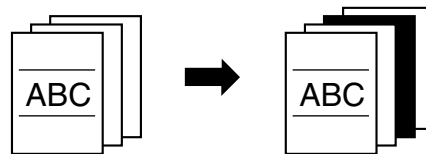

Inserting pages from a different original at specified locations in a copy

An original scanned later can be inserted for specified pages in an original scanned earlier for copying.

For details, refer to ["Inserting copies of a different original for a specified page \("Insert Image" function\)" on page 7-12.](#)

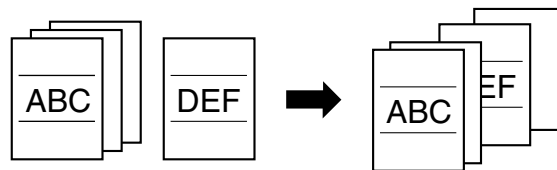

Printing double-sided copies with the specified page on the front side

Double-sided copies can be printed with the specified pages on the front side.

For details, refer to ["Specifying pages to be printed on the front side \("Chapters" function\)" on page 7-15.](#)

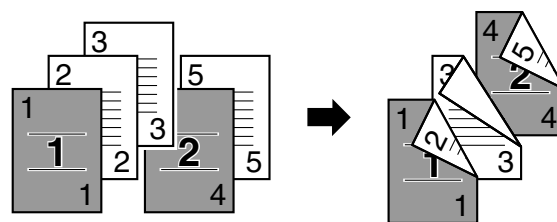

Copying with reversed colors

An original can be copied with the light- and dark-colored areas of the original image inverted.

For details, refer to ["Reversing black-and-white gradation of the original \("Neg./Pos. Reverse" function\)" on page 7-22.](#)

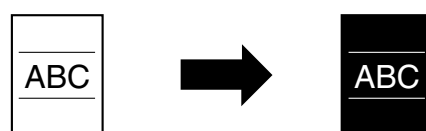

Separately copying a page spread

A page spread, such as in an open book or catalog, can be copied onto separate pages.

For details, refer to ["Producing separate copies of each page in a page spread \("Book Copy" function\)" on page 7-24.](#)

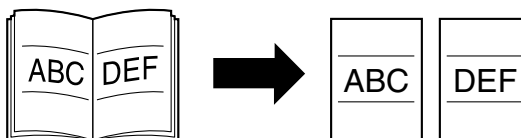

Repeating copy images

An original image can be repeatedly printed on a single sheet of paper.

For details, refer to ["Tiling copy images \("Image Repeat" function\)" on page 7-29.](#)

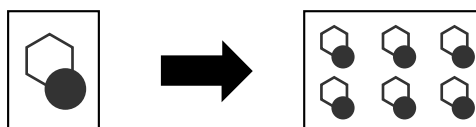

Splitting an original page into two copies

A single original page can be divided in two and each half can be printed on separate copies.

For details, refer to ["Dividing Spread Image into Right and Left Pages using ADF \("Page Separation" function\)" on page 7-33.](#)

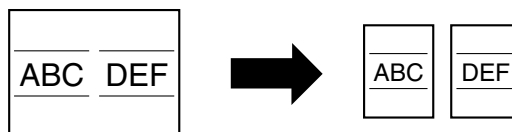

Making copies for filing

Copies can be printed with a filing margin so they can easily be stored in filing binders.

For details, refer to ["Adding a binding margin to copies \("Page Margin" function\)" on page 7-36.](#)

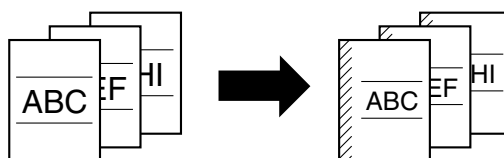

Adjusting the image to fit the paper size

When the copy paper is larger than the original, copies can be printed so that the original image fills the paper.

For details, refer to ["Adjusting the image to fit the paper \("Image Adjust" settings\)" on page 7-39.](#)

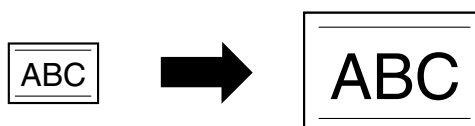

Copying with the page layout of a magazine

Copies can be made with the pages arranged in a layout for center binding, such as for a magazine.

For details, refer to ["Copying with the page layout of a booklet \("Booklet" function\)" on page 7-42.](#)

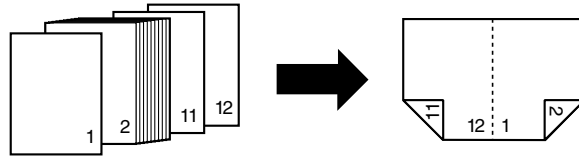

Erasing sections of copies

Areas, such as the shadows of punched holes, bindings/edges of books, and transmission information in received faxes, can be erased in copies.

For details, refer to ["Erasing black marks along borders \("Erase" function\)" on page 7-46.](#)

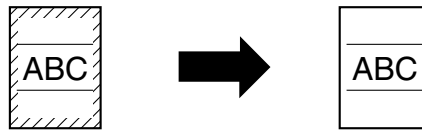

Printing a sample copy

Before printing a large number of copies, a single sample copy can be printed so that it can be checked.

For details, refer to ["Printing a proof to check the settings \(Proof Copy\)" on page 3-5.](#)

Printing date/time or page number on copies

The date/time, page number or distribution number per set can be printed on copies.

For details, refer to ["Printing the date/time or page number on copies \(Stamp/Composition functions\)" on page 7-51.](#)

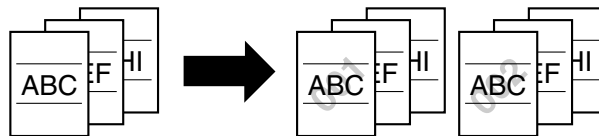

Managing jobs

The print status of copy jobs can be checked and the jobs can be managed.

For details, refer to ["Managing jobs" on page 10-2.](#)

Programming copy settings

Frequently used copy settings can be programmed and recalled to be used with other copy jobs.

For details, refer to ["Registering copy programs \(Mode Memory\)" on page 3-8.](#)

Checking the copy settings

Screens showing the current copy settings can be displayed. From these screens, the copy settings can also be changed.

For details, refer to ["Checking the Copy Settings \(Check Job\)" on page 3-2.](#)

Enlarging the size of text in touch panel screens

The text and buttons in the touch panel can be displayed in a larger size that is easier to read, allowing basic operations to be easily performed.

For details, refer to the User's Guide [Enlarge Display Operations].



Displaying explanations of functions and settings

The name and function of parts and details of functions and settings appears in the Help screens.

For details, refer to ["Displaying function descriptions \(Help\)" on page 3-13](#).

Interrupting a copy job

The copy job being printed can be interrupted in order for a different copy job to be printed.

For details, refer to ["Interrupting a copy job \(Interrupt mode\)" on page 3-7](#).

Titles indicate the contents of the section.

Text that appears in this manner describes the function limitations and options required to use certain functions.

Text that appears in this manner describes supplemental information, such as precautions, references and actions, relating to steps.

Text that appears in this manner provides answers to problems and questions that may occur during operation.

8

Application functions

7.6 Producing separate copies of each page in a page spread ("Book Copy" function)

A page spread, such as in an open book or catalog, can be copied with the left and right pages on separate pages or both on the same page.

To copy using the "Book Copy" function

- ✓ Place the original on the original glass.

⚠ CAUTION

Handling toner and the toner cartridges

- Do not throw toner or the toner cartridge into a fire.
- Toner expelled from the fire may cause burns.

- 1 Place the pages on the original glass, starting with the first page.
 - For details on positioning the original, refer to "Feeding the original" on page 2-7.
 - To add copies of the covers, load them first.
- ? How are the front and back covers copied?
 - Scan the front cover, then the back cover, and then scan the remainder of the original.
- 2 Load the paper to be used into the desired paper tray.
- 3 Touch [Application], and then touch [Book Scan/Repeat].
 - To cancel all settings for the Application functions, touch [Reset].

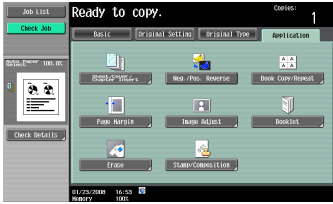

The Book Scan/Repeat screen appears.

Application functions

Chapter 8

751/601

7-21

⚠ WARNING , CAUTION

Text highlighted in this manner indicates precautions to ensure safe use of this machine. "Warning" indicates instructions that, when not observed, may result in fatal or critical injuries. "Caution" indicates instructions that, when not observed, may result in serious injuries or property damage.

(The page shown above is an example only.)

[] Names highlighted as shown above indicate keys on the control panel, buttons in the touch panel, and the power switches.

Chapter 8 Application functions

8 Application functions

4 Touch [Book Copy].

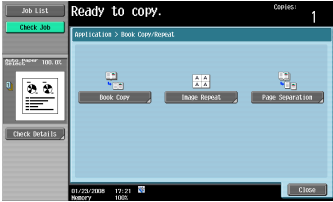

The Book Copy screen appears.

5 Touch the button for the desired setting.



7-22 751/601

Touch panel screens are shown to check the actual display.

... **Reminder** Text highlighted in this manner indicates operation precautions. Carefully read and observe this type of information.

... **Reminder** Do not replace the toner cartridge until the message "There is no Toner." appears. In addition, do not replace the toner cartridge of any color other than the one indicated in the message on the touch panel.

... **Note** Even though the setting can be specified in increments of 1/3, the setting will appear at the nearest full increment in the Adjust Color screen.

... **Detail** If the "Single Color" function is set, the colors are inverted with the selected color. If the "Background Color" function is set, the colors, including the selected background color, are inverted.

... **Detail** Text highlighted in this manner provides more detailed information concerning operating procedures or references to sections containing additional information. If necessary, refer to the indicated sections.

... **Note** Text highlighted in this manner contains references and supplemental information concerning operating procedures and other descriptions. We recommend that this information be read carefully.

(The page shown above is an example only.)

Descriptions of originals and paper

The descriptions used in this manual for originals and paper are explained below.

Whenever original and paper dimensions are mentioned in this manual, the value shown as Y in the illustration refers to the width, and the value shown as X refers to the length.

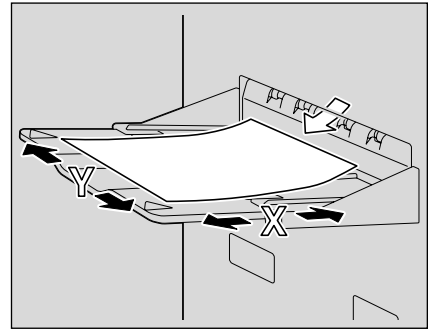

Lengthwise (☐)

If the width (Y) of the paper is shorter than the length (X), the paper has a vertical or portrait orientation, indicated by ☐.

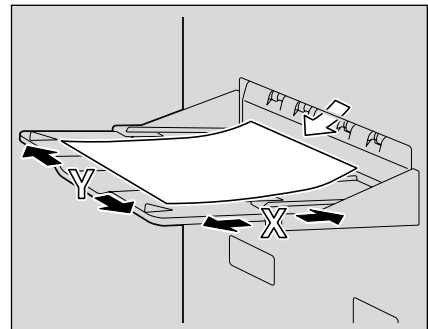

Crosswise (☐)

If the width (Y) of the paper is longer than the length (X), the paper has a horizontal or landscape orientation, indicated by ☐.

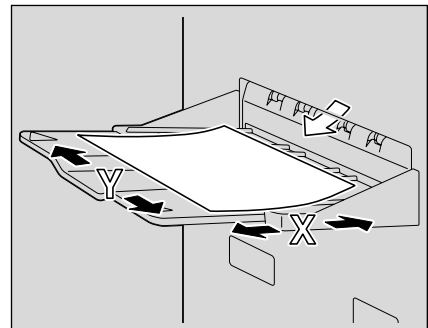

User's Guides

This machine is provided with printed manuals and PDF manuals on the User's Guide CD.

Printed manual

Quick Guide [Copy/Print/Fax/Scan/Box Operations]

This manual contains operating procedures and descriptions of the most frequently used functions, allowing the machine to immediately be used.

In addition, this manual contains notes and precautions that should be followed for safe use of the machine.

Be sure to read this manual before using the machine.

User's Guide CD manuals

User's Guide [Copy Operations] (this manual)

This manual contains descriptions of the Copy mode operations and machine maintenance.

Refer to this manual for details on the paper and originals, copy procedures using convenient Application functions, replacing consumables, and troubleshooting operations such as clearing paper misfeeds.

User's Guide [Enlarge Display Operations]

This manual contains details on operating procedures in Enlarge Display mode.

Refer to this manual for details on using copy, scanner, G3 fax, and network fax operations in Enlarge Display mode.

User's Guide [Print Operations (IC-208)]

This manual contains details of the printing functions that can be specified with the optional image controller.

Refer to this manual for operating procedures on using the printing functions.

User's Guide [Box Operations]

This manual contains operating procedures for using the user boxes on the optional hard disk.

Refer to this manual for details on saving data in user boxes, retrieving data from user boxes and transferring data.

User's Guide [Network Scan/Fax/Network Fax Operations]

This manual contains details on the network scan, G3 fax, and network fax operations.

Refer to this manual for details on using network scan function by E-Mail or FTP, G3 fax, Internet fax and IP address fax operations.

In order to use the fax functions, the optional fax kit must be purchased separately.

User's Guide [Fax Driver Operations]

This manual contains details of the fax driver functions that can be used to send a fax directly from a computer.

Refer to this manual for operating procedures on using the PC-FAX functions.

In order to use the fax functions, the optional fax kit must be purchased separately.

User's Guide [Network Administrator]

This manual contains descriptions on setting methods for each function utilizing network connection, mainly using the PageScope Web Connection.

Refer to this manual for details on using network functions.

Trademarks/Copyrights

This manual contains descriptions on trademarks and copyrights.

Be sure to read this manual before using the machine.

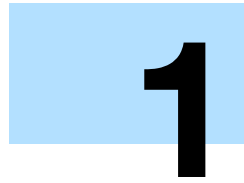

Before Making Copies

1 Before Making Copies

1.1 Machine Configuration

1.1.1 Options

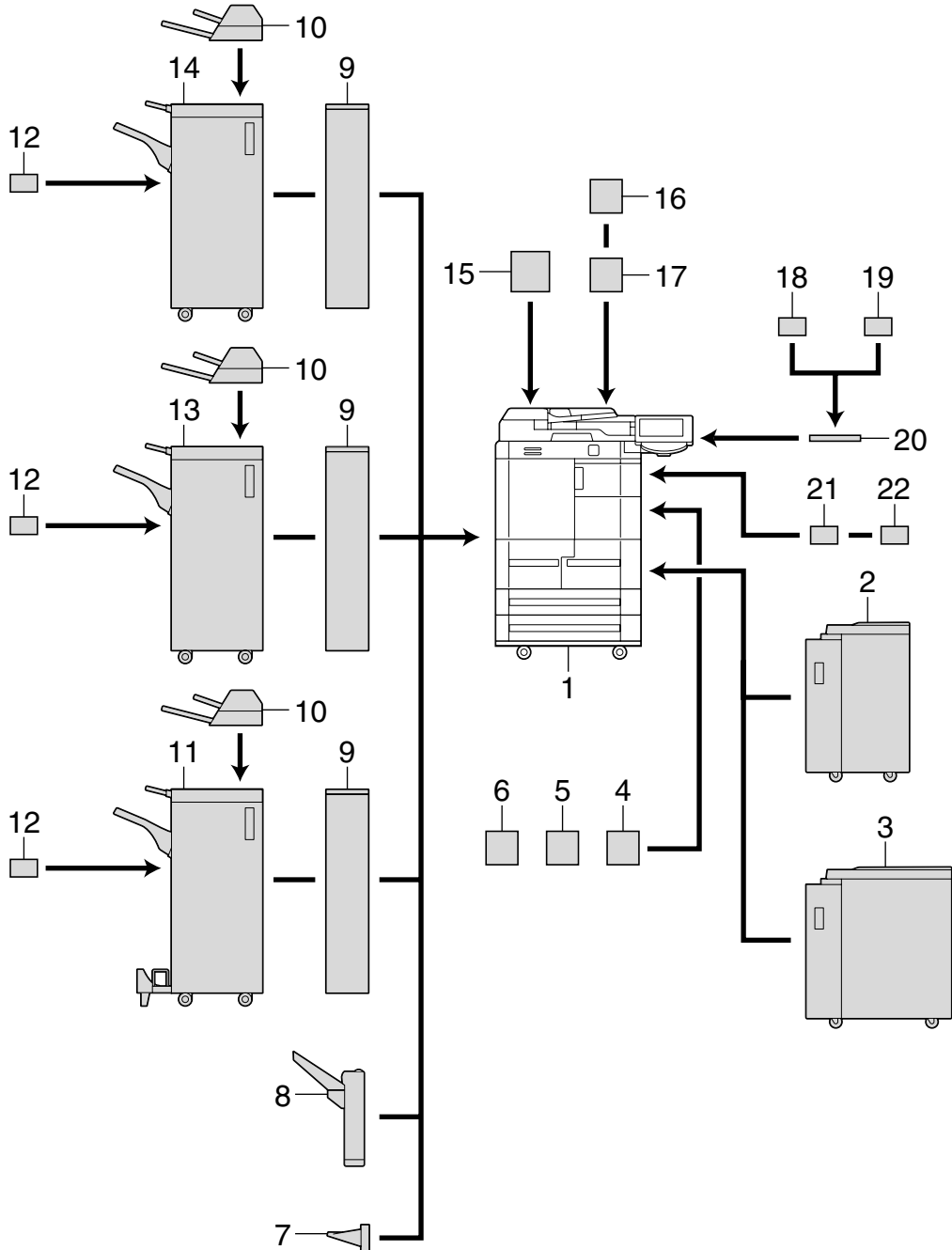

No.	Part name	Description
1	Main unit	Consists of a scanner, a printer, an ADF, and paper trays (4 trays and 1 bypass tray).
2	Large Capacity Unit LU-405	Can be loaded with up to 4,000 sheets of paper (20 lb).
3	Large Capacity Unit LU-406	Can be loaded with up to 4,000 sheets of paper (20 lb).

No.	Part name	Description
4	Local Interface Kit EK-703	Installed when using the machine as a printer connected directly with a PC.
5	Security Kit SC-506	Installed to encode the data saved on the hard disk so that the hard disk can be used more safely.
6	Hard Disk HD-510	Installed to increase the scanning capacity or enabling scanning of multiple jobs.
7	Output Tray OT-505	Collects printed sheets.
8	Shift Tray SF-602	Separates copies fed out at an offset.
9	Z Folding Unit ZU-605	Installed with the finisher to enable Z-folding and hole punching.
10	Post Inserter PI-504	Installed with the finisher to enable insertion of the cover sheet into the printed sheets. In addition, you can operate the finisher manually.
11	Finisher FS-610	Collects printed sheets. Provides selectable finishing functions: sort, group, offset-sort, offset-group, staple, face up, center staple & fold, half-fold, and tri-fold.
12	Punch Kit PK-505	Installed with the finisher to enable hole punching.
13	Finisher FS-525	Collects printed sheets. Provides selectable finishing functions: sort, group, offset-sort, offset-group, face up, and staple.
14	Finisher FS-524	Collects printed sheets. Provides selectable finishing functions: sort, group, offset-sort, offset-group, face up, and staple.
15	Image Controller IC-208	Installed when this machine is used for network printing and network scanning.
16	Fax Kit FK-502	Allows this machine to be used as a fax machine.
17	Mount Kit MK-716	Used to install the Fax kit.
18	Authentication Unit (biometric type) AU-101	Scans vein patterns in the finger to verify user authentication.
19	Authentication Unit (IC card type) AU-201	Reads the information stored on an IC card to verify user authentication.
20	Working Table WT-504	Provides an area to temporarily place originals and other materials. This is also used when the authentication unit is installed.
21	Key Counter Socket	Required for installing the key counter.
22	Key Counter	Installed onto this machine to make the counter function available for printed sheets.

1.1.2 External

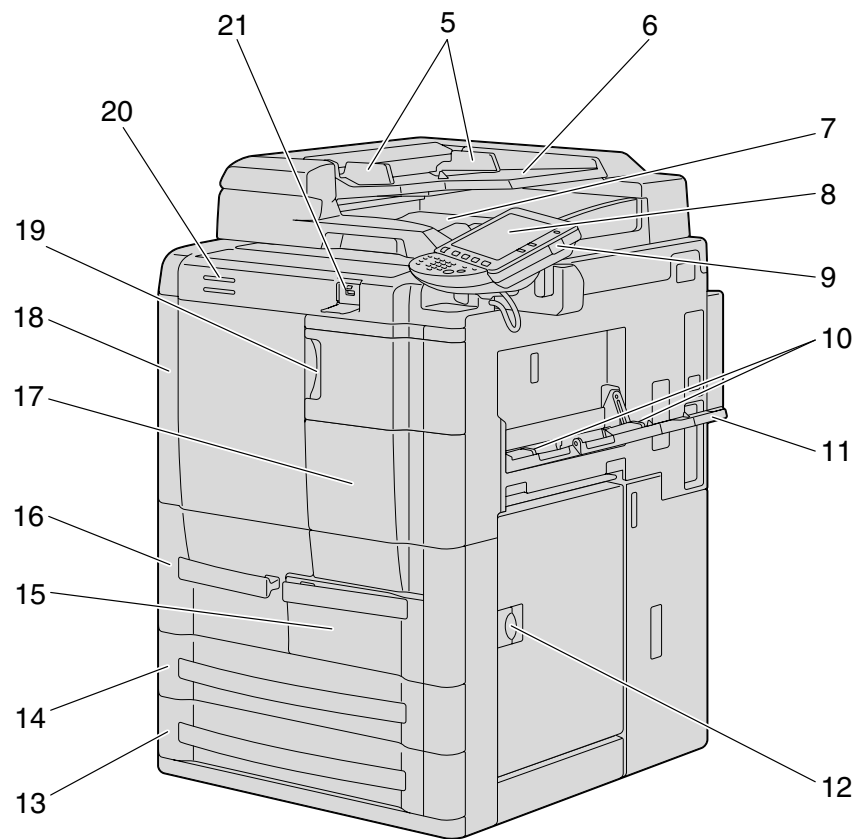
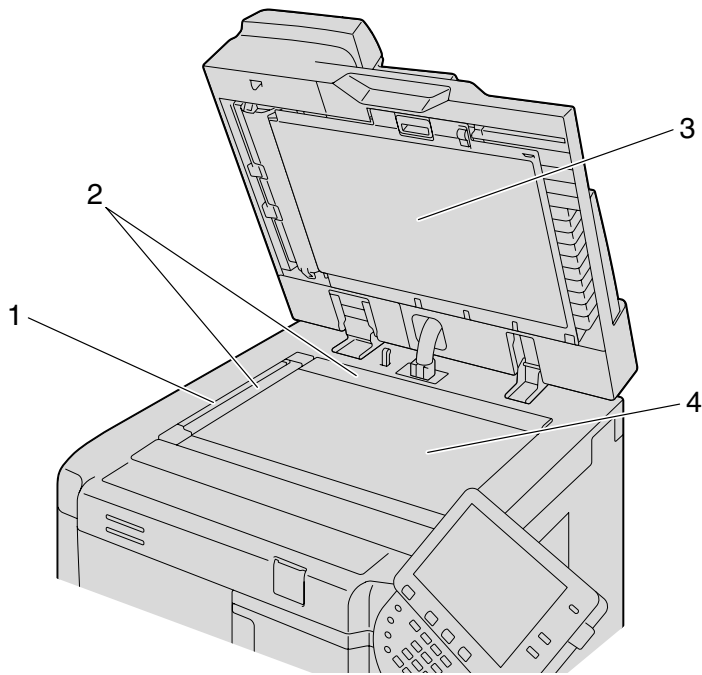

Reminder

Do not grab the control panel to move the machine.

No.	Part name	Description
1	Left partition glass	Scans the original loaded into the ADF.
2	Document scales	Use as a guide when placing the original on the original glass.
3	Document pad	Presses down on the original positioned on the original glass.
4	Original glass	Scans the original placed face down.
5	Adjustable paper guides	Used to align the loaded original.
6	Paper tray	Load with the originals to be scanned facing up.
7	Original output tray	Feeds out scanned originals.
8	Control panel	Used to specify the various settings and perform operations such as starting.
9	[Power] (auxiliary power) key	Turns on/off the copying and scanning functions. Turning it off will terminate all the functions other than printing, and receiving and outputting facsimile data, and then enter the sleep mode.
10	Adjustable document guides	Used to align the loaded paper.
11	Bypass tray	Opened and used when printing onto paper that is not or cannot (such as thick paper, overhead projector transparencies, envelopes or label sheets) be loaded into a paper tray.
12	Release lever for the vertical transport door of the main unit	Used to open the vertical transport door when clearing paper misfeeds.
13	Tray 4	A maximum of 500 sheets of 11 × 17 to 5-1/2 × 8-1/2 plain paper 21-1/4 lb can be loaded.
14	Tray 3	A maximum of 500 sheets of 11 × 17 to 5-1/2 × 8-1/2 plain paper 21-1/4 lb can be loaded.
15	Tray 2	A maximum of 1,000 sheets of 8-1/2 × 11 or 5-1/2 × 8-1/2 plain paper 21-1/4 lb can be loaded.
16	Tray 1	A maximum of 1,500 sheets of 8-1/2 × 11 or 5-1/2 × 8-1/2 plain paper 21-1/4 lb can be loaded.
17	Right front door	Opened when clearing paper misfeeds.
18	Left front door	Opened when clearing paper misfeeds.
19	Toner cartridge door	Opened when replacing a toner cartridge.
20	Machine status indicator	Indicates machine status by combining the color (blue or red) and the state (steady on or blinking).
21	USB port (type A) USB 2.0/1.1	Used for connecting external memory (USB memory device).

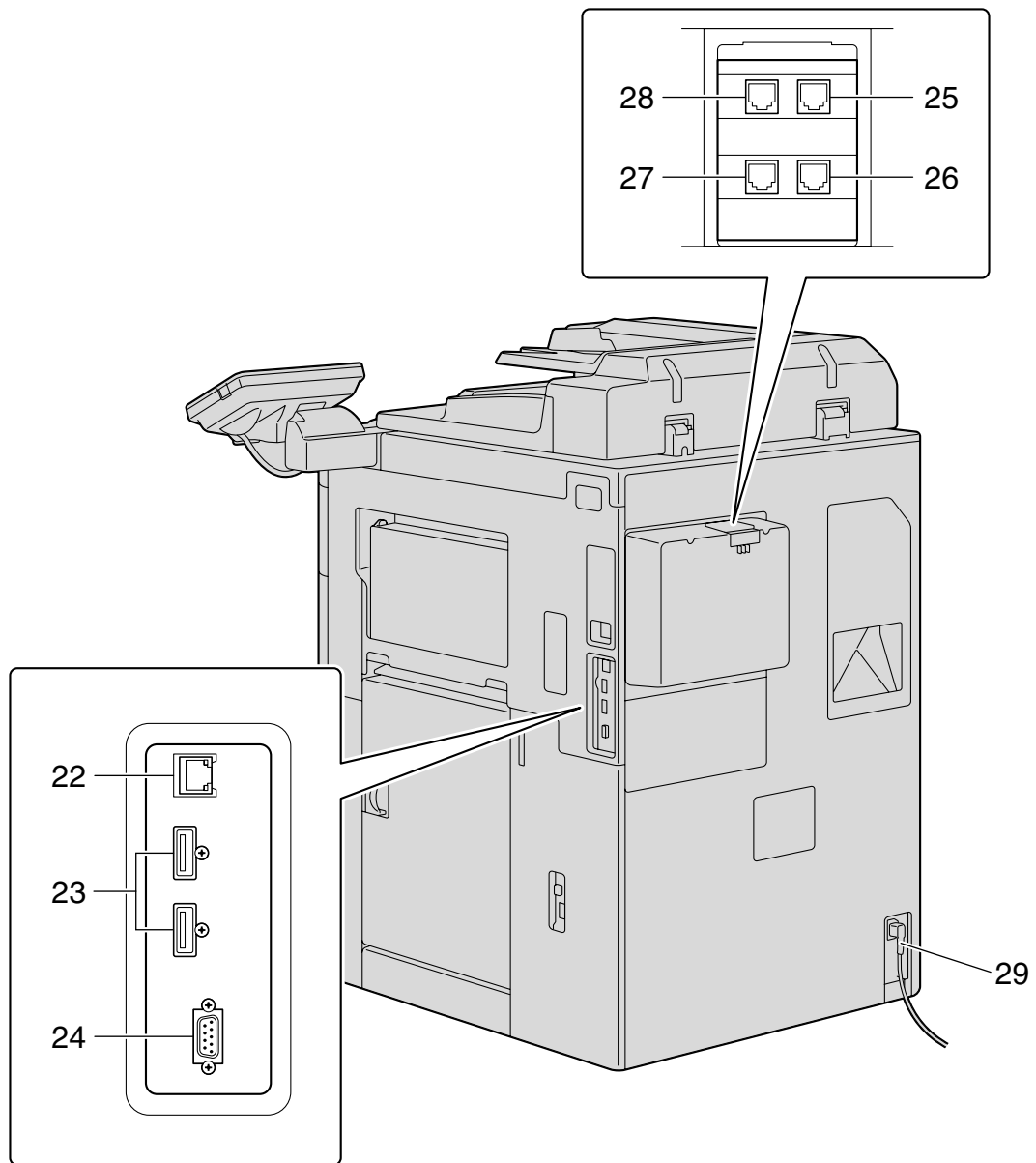

No.	Part name	Description
22	Network connector (10Base-T/100Base-TX/1000Base-T)	Used for connecting the network cable when this machine is used for network printing and network scanning.
23	USB port (type A) USB 2.0/1.1	Used for connecting the USB cable for the authentication unit (biometric type) or the authentication unit (IC card type).
24	RS-232C port	Used for connecting the modem for CS Remote Care.
25	Telephone jack 1 (LINE PORT1)	Used for connecting a general subscriber line.
26	Telephone jack 2 (LINE PORT2)	Used for connecting a general subscriber line. This jack is used when the optional fax multi line kit has been installed.
27	Jack for connecting a telephone (TEL PORT1)	Used for connecting the cord from a telephone.

No.	Part name	Description
28	Jack for connecting a telephone (TEL PORT2)	Used for connecting the cord from a telephone.
29	Power cord	Supplies power to the machine.

1.1.3 Internal

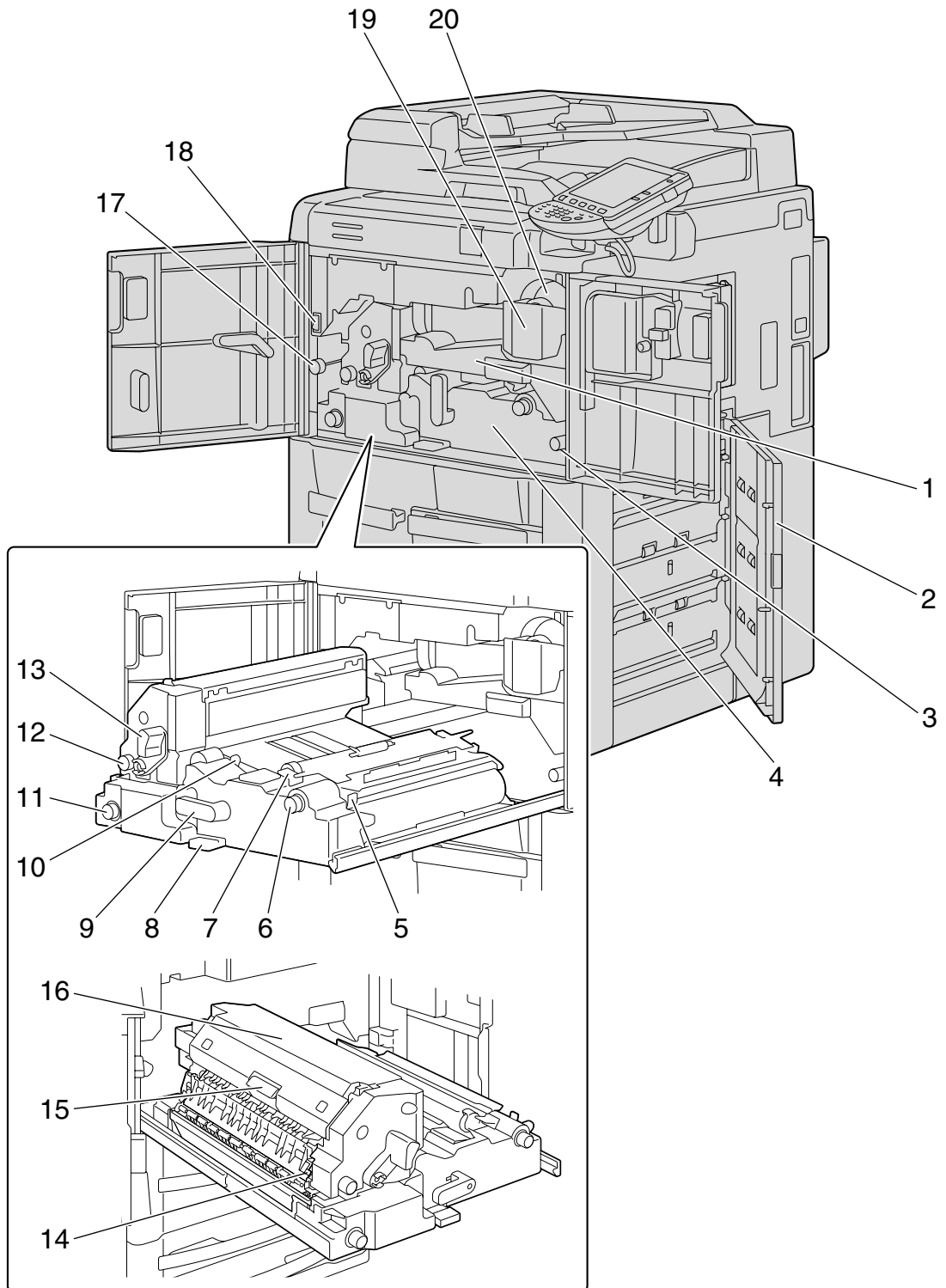

No.	Part name	Description
1	Drum section	Forms the copy image.
2	Vertical transport door	Opened when clearing paper misfeeds in the vertical transport section.
3	Dial M1	Turned when clearing paper misfeeds within the ADU unit.
4	ADU unit	Pulled out when clearing paper misfeeds.
5	Cover M12	Opened when clearing paper misfeeds within the ADU unit.
6	Dial M2	Turned when clearing paper misfeeds within the ADU unit.
7	Cover M3	Opened when clearing paper misfeeds within the ADU unit.
8	Cover M11	Opened when clearing paper misfeeds within the ADU unit.
9	Lever M4	Lowered to the left in order to pull out the ADU unit when clearing paper misfeeds.
10	Transport lever	Switched when printing on 5-1/2 × 8-1/2 or A5-size thick paper.
11	Dial M9	Turned when clearing paper misfeeds within the ADU unit.
12	Dial M7	Turned when clearing paper misfeeds within the ADU unit.
13	Lever M5	Lowered to the left when clearing paper misfeeds.
14	Cover M8	Opened when clearing paper misfeeds within the ADU unit.
15	Cover M6	Opened when clearing paper misfeeds within the ADU unit.
16	Fusing unit	Fuses the image that was formed onto the paper.
17	Dial M10	Turned when clearing paper misfeeds within the ADU unit.
18	Main power switch	Used to turn the machine on and off.
19	Toner-cartridge-securing lever	Pull toward you to remove the toner unit when replacing a toner cartridge.
20	Toner cartridge	Replaced when the toner is empty.

1.1.4 Large Capacity Unit LU-405

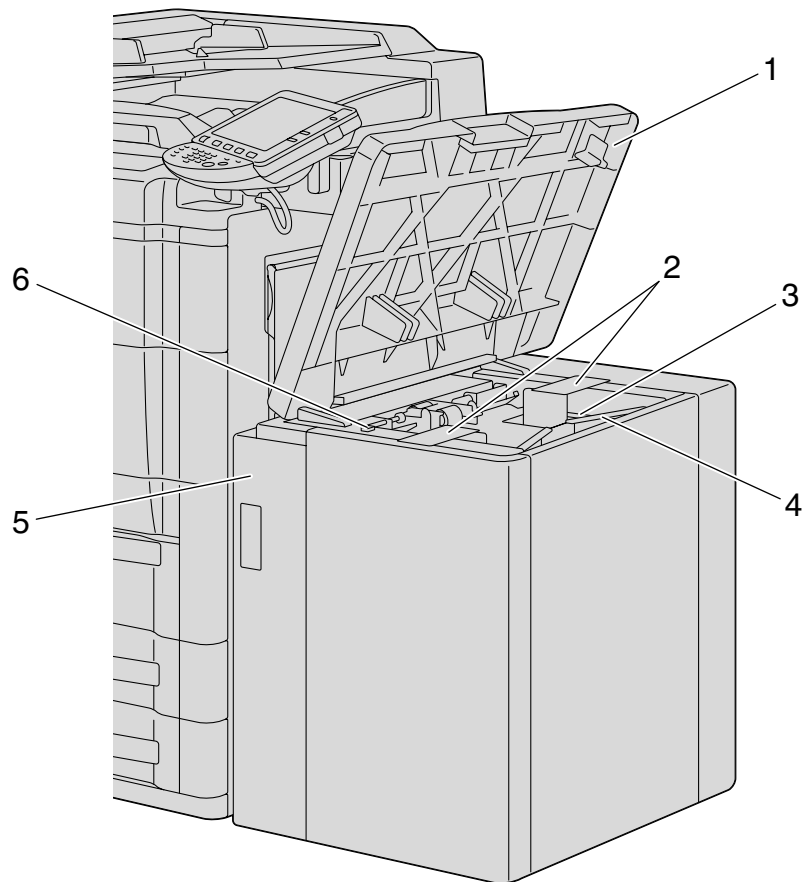

Reminder

Do not climb on, or place objects on this unit to prevent any damage.

Large Capacity Unit LU-405

No.	Part name	Description
1	Upper cover	Opened when loading paper or clearing paper misfeeds.
2	Lateral guides	Secures the sides of the paper to be loaded.
3	Tray bottom plate	Raised as the paper is used. Lower by pressing the bottom-plate-lowering button.
4	Trailing edge stopper	Secures the trailing edges of the paper to be loaded.
5	Large capacity tray front door	Opened when clearing paper misfeeds.
6	Tray bottom plate lower button	Pressed to lower the bottom plate in the paper tray when loading paper.

1.1.5 Large Capacity Unit LU-406

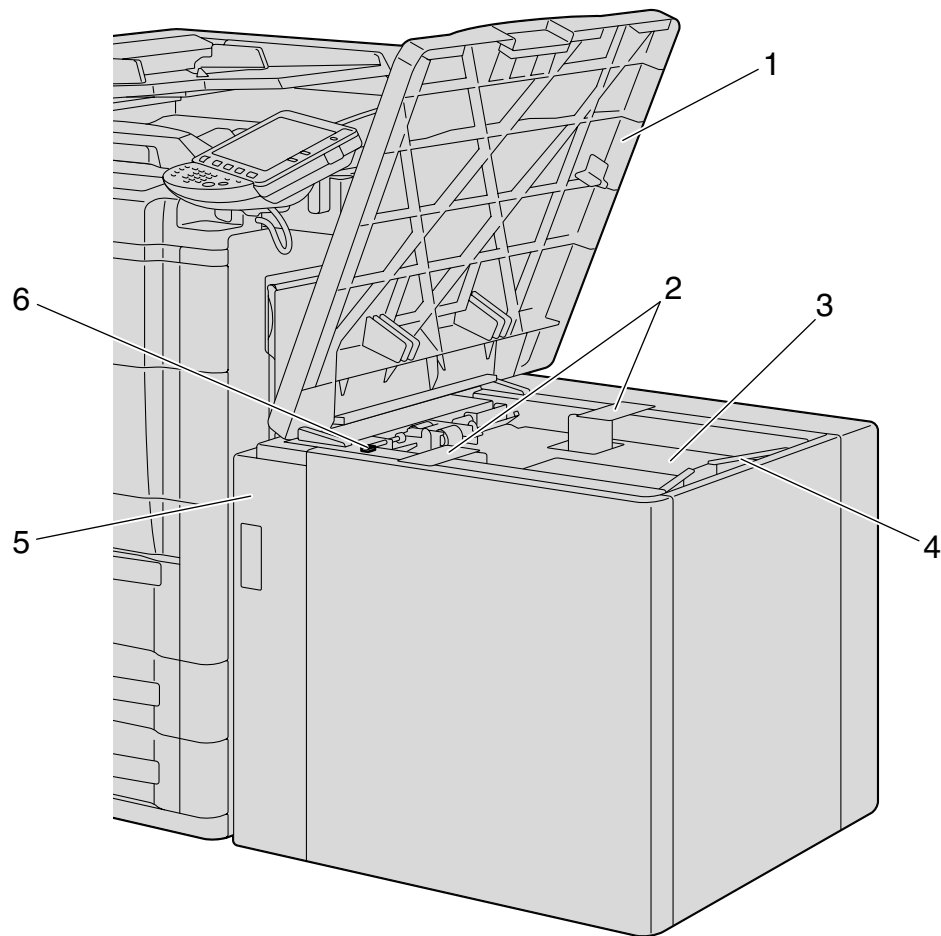

Reminder

Do not climb on, or place objects on this unit to prevent any damage.

Large Capacity Unit LU-406

No.	Part name	Description
1	Upper cover	Opened when loading paper or clearing paper misfeeds.
2	Lateral guides	Secures the sides of the paper to be loaded.
3	Tray bottom plate	Raised as the paper is used. Lower by pressing the bottom-plate-lowering button.
4	Trailing edge stopper	Secures the trailing edges of the paper to be loaded.
5	Large capacity tray front door	Opened when clearing paper misfeeds.
6	Tray bottom plate lower button	Pressed to lower the bottom plate in the paper tray when loading paper.

1.1.6 Finisher FS-524/Punch Kit PK-505

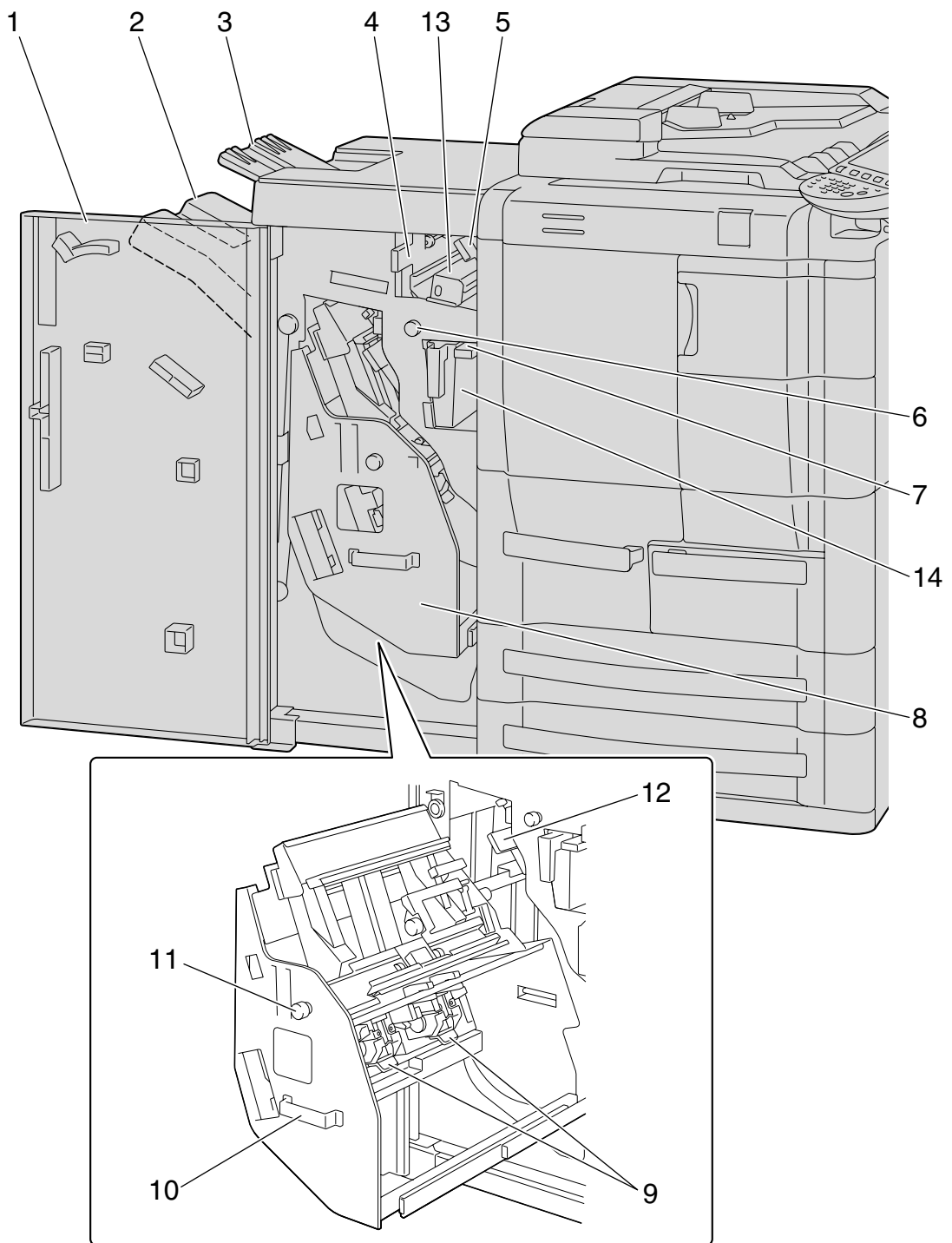

Finisher FS-524

No.	Part name	Description
1	Front door	Opened when clearing paper misfeeds or jammed staples or when replacing the staple cartridge.
2	Main finishing tray (Tray 2)	Collects printed pages.
3	Sub finishing tray (Tray 1)	Collects printed pages.
4	Guide lever FN4	Opened when clearing paper misfeeds.

No.	Part name	Description
5	Guide lever FN1	Opened when clearing paper misfeeds.
6	Misfeed-clearing dial FN3	Turned when clearing paper misfeeds within the finisher.
7	Guide lever FN2	Opened when clearing paper misfeeds.
8	Stacker unit	Removed when clearing paper misfeeds or jammed staples or when replacing the staple cartridge.
9	Staple cartridge holder	Removed from the stacker unit when clearing jammed staples or when replacing the staple cartridge.
10	Handle FN7	Grabbed when removing and inserting the stacker unit.
11	Misfeed-clearing dial FN6	Turned when clearing paper misfeeds within the finisher.
12	Guide lever FN5	Opened when clearing paper misfeeds.

Punch Kit PK-505

No.	Part name	Description
13	Punch kit	Punches holes for filing printed pages when the punch kit is installed with Finisher FS-524.
14	Hole-punch scrap box	Removed when emptying punch scraps that have accumulated from using the Punch settings.

1.1.7 Finisher FS-525/Punch Kit PK-505

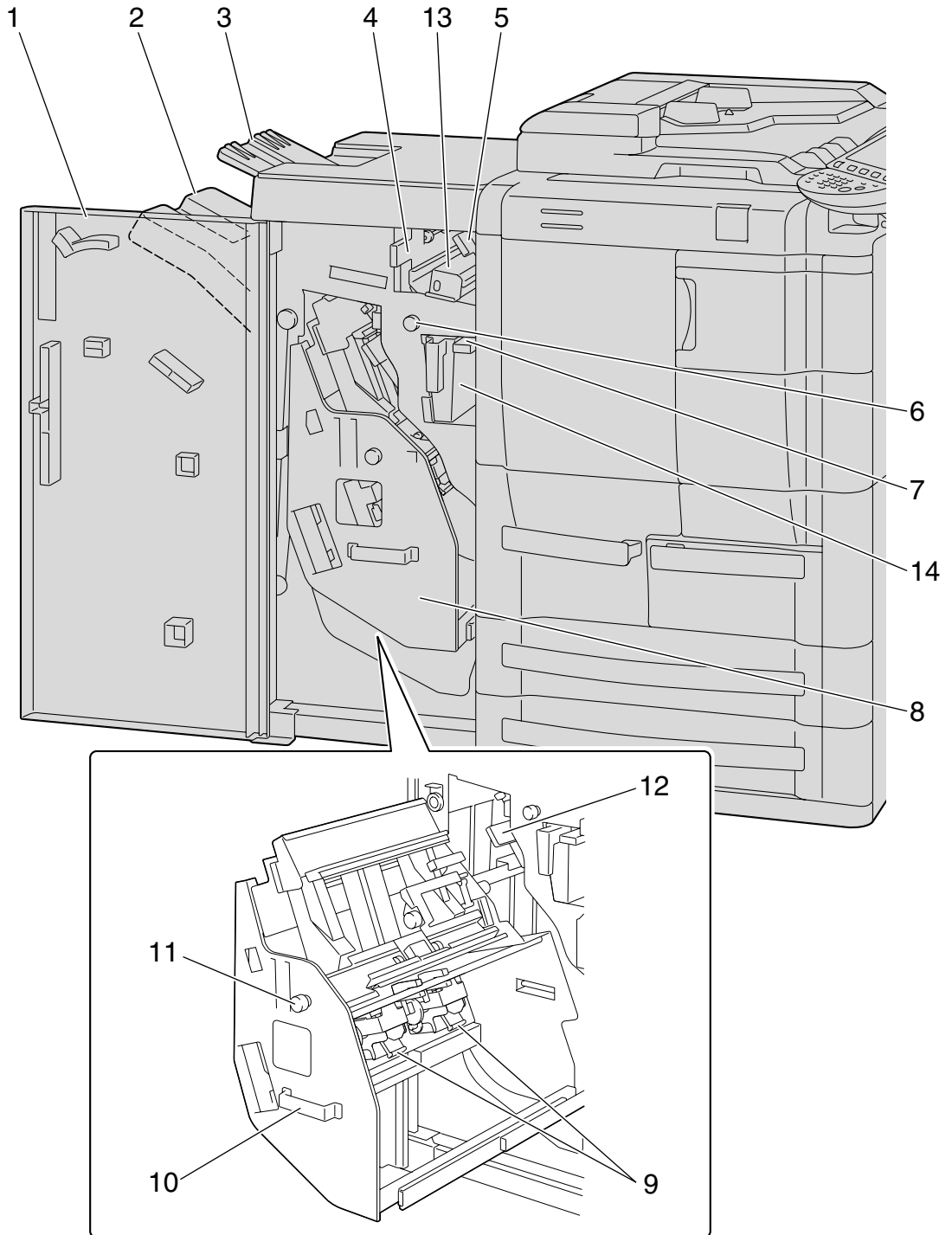

Finisher FS-525

No.	Part name	Description
1	Front door	Opened when clearing paper misfeeds or jammed staples or when replacing the staple cartridge.
2	Main finishing tray (Tray 2)	Collects printed pages.
3	Sub finishing tray (Tray 1)	Collects printed pages.
4	Guide lever FN4	Opened when clearing paper misfeeds.
5	Guide lever FN1	Opened when clearing paper misfeeds.
6	Misfeed-clearing dial FN3	Turned when clearing paper misfeeds within the finisher.
7	Guide lever FN2	Opened when clearing paper misfeeds.
8	Stacker unit	Removed when clearing paper misfeeds or jammed staples or when replacing the staple cartridge.
9	Staple cartridge holder	Removed from the stacker unit when clearing jammed staples or when replacing the staple cartridge.
10	Handle FN7	Grabbed when removing and inserting the stacker unit.
11	Misfeed-clearing dial FN6	Turned when clearing paper misfeeds within the finisher.
12	Guide lever FN5	Opened when clearing paper misfeeds.

Punch Kit PK-505

No.	Part name	Description
13	Punch kit	Punches holes for filing printed pages when the punch kit is installed with Finisher FS-525.
14	Hole-punch scrap box	Removed when emptying punch scraps that have accumulated from using the Punch settings.

1.1.8 Finisher FS-610/Punch Kit PK-505

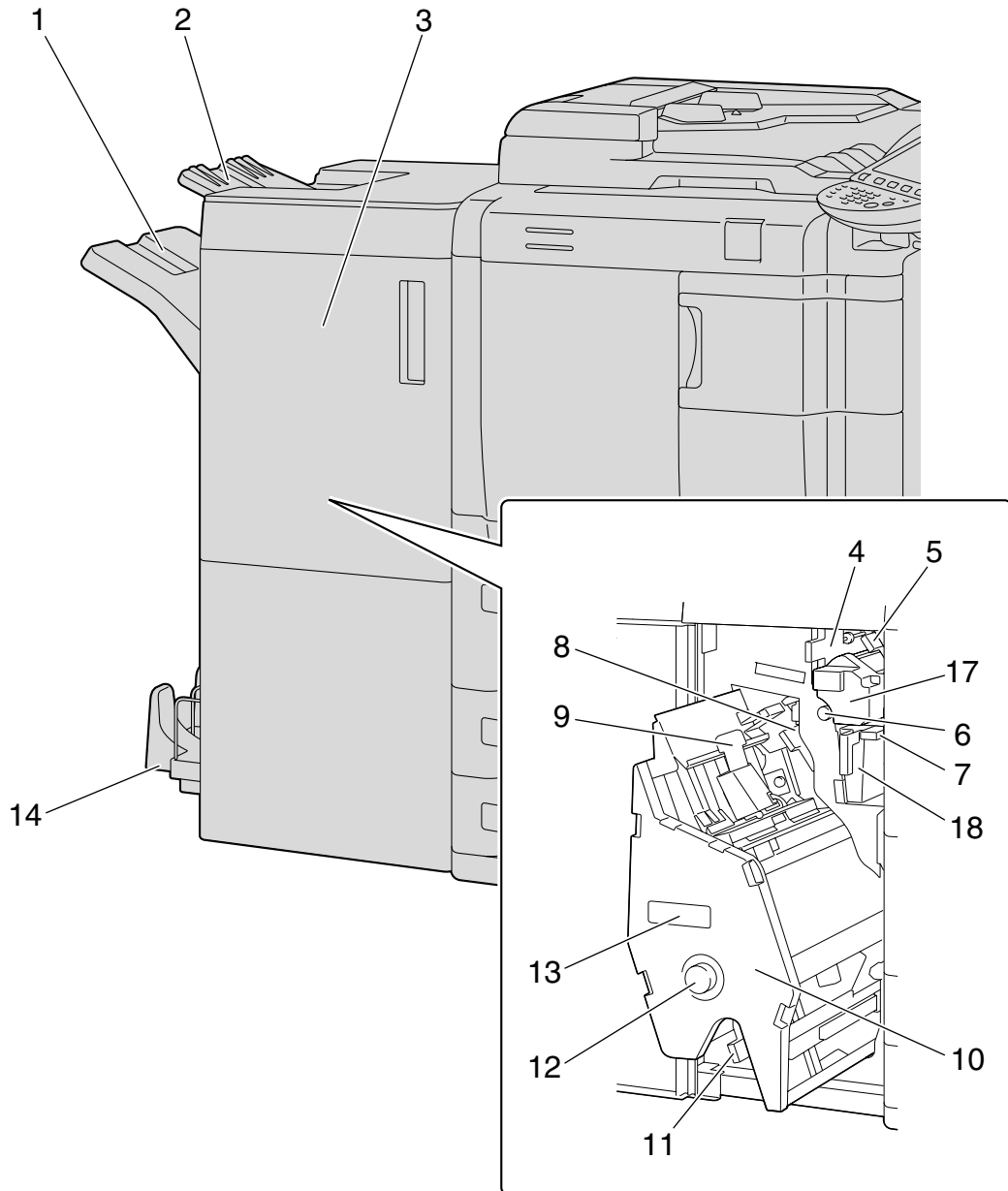

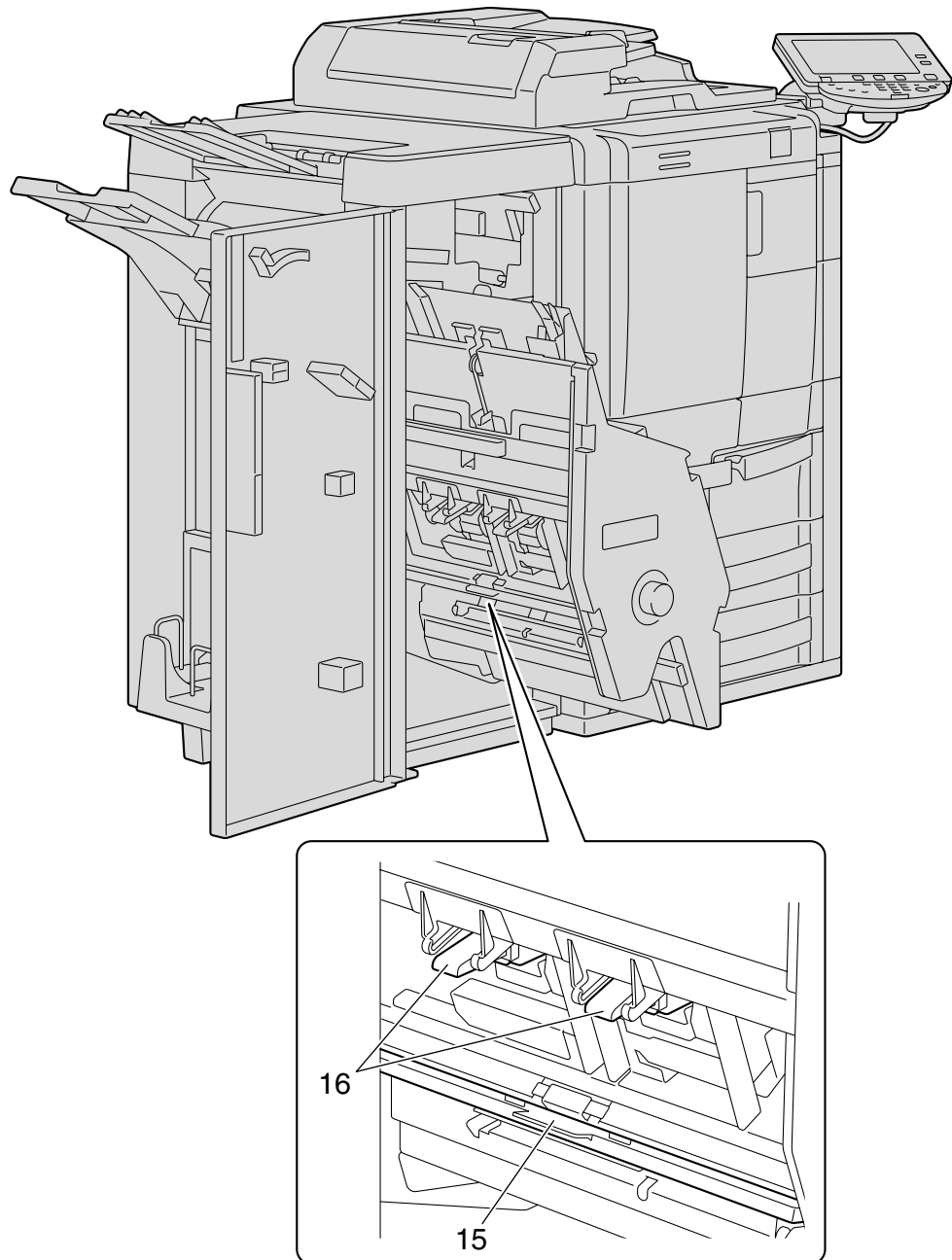

Finisher FS-610

No.	Part name	Description
1	Main finishing tray (Tray 2)	Collects printed pages.
2	Sub finishing tray (Tray 1)	Collects printed pages.
3	Front door	Opened when clearing paper misfeeds or jammed staples or when replacing the staple cartridge.
4	Guide lever FN4	Opened when clearing paper misfeeds.
5	Guide lever FN1	Opened when clearing paper misfeeds.
6	Misfeed-clearing dial FN3	Turned when clearing paper misfeeds within the finisher.
7	Guide lever FN2	Opened when clearing paper misfeeds.
8	Guide lever FN5	Opened when clearing paper misfeeds.
9	Guide lever FN9	Opened when clearing paper misfeeds.
10	Stacker unit	Pulled out when clearing paper misfeeds or jammed staples or when replacing the staple cartridge.

No.	Part name	Description
11	Guide lever FN8	Opened when clearing paper misfeeds.
12	Misfeed-clearing dial FN7	Turned when clearing paper misfeeds within the finisher.
13	Handle FN6	Grabbed when removing and inserting the stacker unit.
14	Booklet tray	Collects copies printed using a Fold/Bind setting.
15	Guide lever FN10	Opened when clearing paper misfeeds.
16	Staple cartridge holder	Removed from the stacker unit when clearing jammed staples or when replacing the staple cartridge.

Punch Kit PK-505

No.	Part name	Description
17	Punch kit	Punches holes for filing printed pages when the punch kit is installed with Finisher FS-610.
18	Hole-punch scrap box	Removed when emptying punch scraps that have accumulated from using the Punch settings.

1.1.9 Z Folding Unit ZU-605

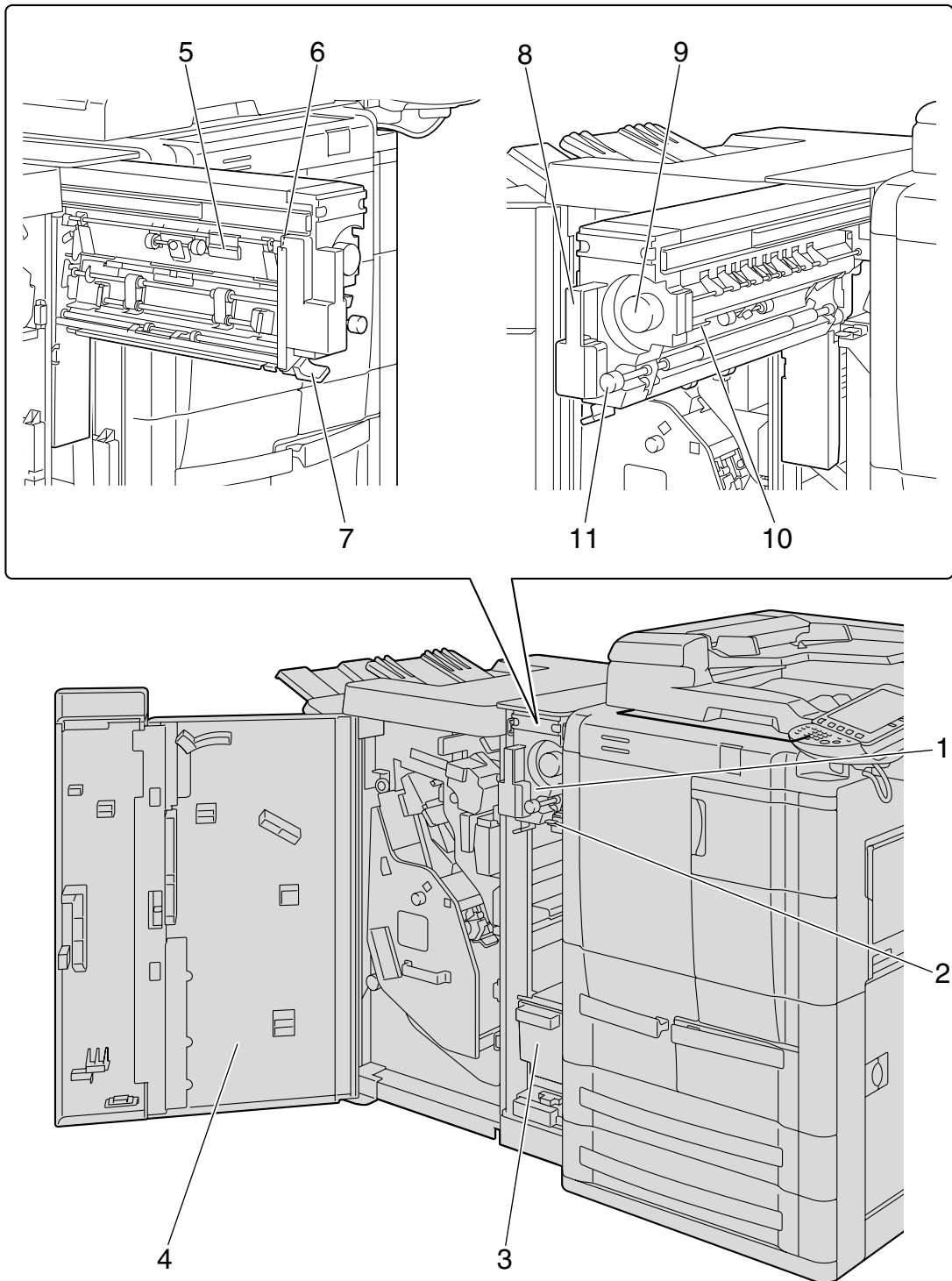

No.	Part name	Description
1	Z folding/transport unit	Pulled out when removing jammed paper.
2	Guide lever FN1	Opened when clearing paper misfeeds.
3	Hole-punch scrap box	Removed when emptying punch scraps that have accumulated from using the Punch settings.
4	Front door	Opened when clearing paper misfeeds or punch scraps.
5	Guide lever FN6	Opened when clearing paper misfeeds.

No.	Part name	Description
6	Guide lever FN7	Opened when clearing paper misfeeds.
7	Guide lever FN8	Opened when clearing paper misfeeds.
8	Handle FN2	Grabbed when removing and inserting the unit.
9	Misfeed-clearing dial FN5	Turned when removing paper jammed in the Z folding unit.
10	Guide lever FN3	Opened when clearing paper misfeeds.
11	Misfeed-clearing dial FN4	Turned when removing paper jammed in the Z folding unit.

1.1.10 Post Inserter PI-504

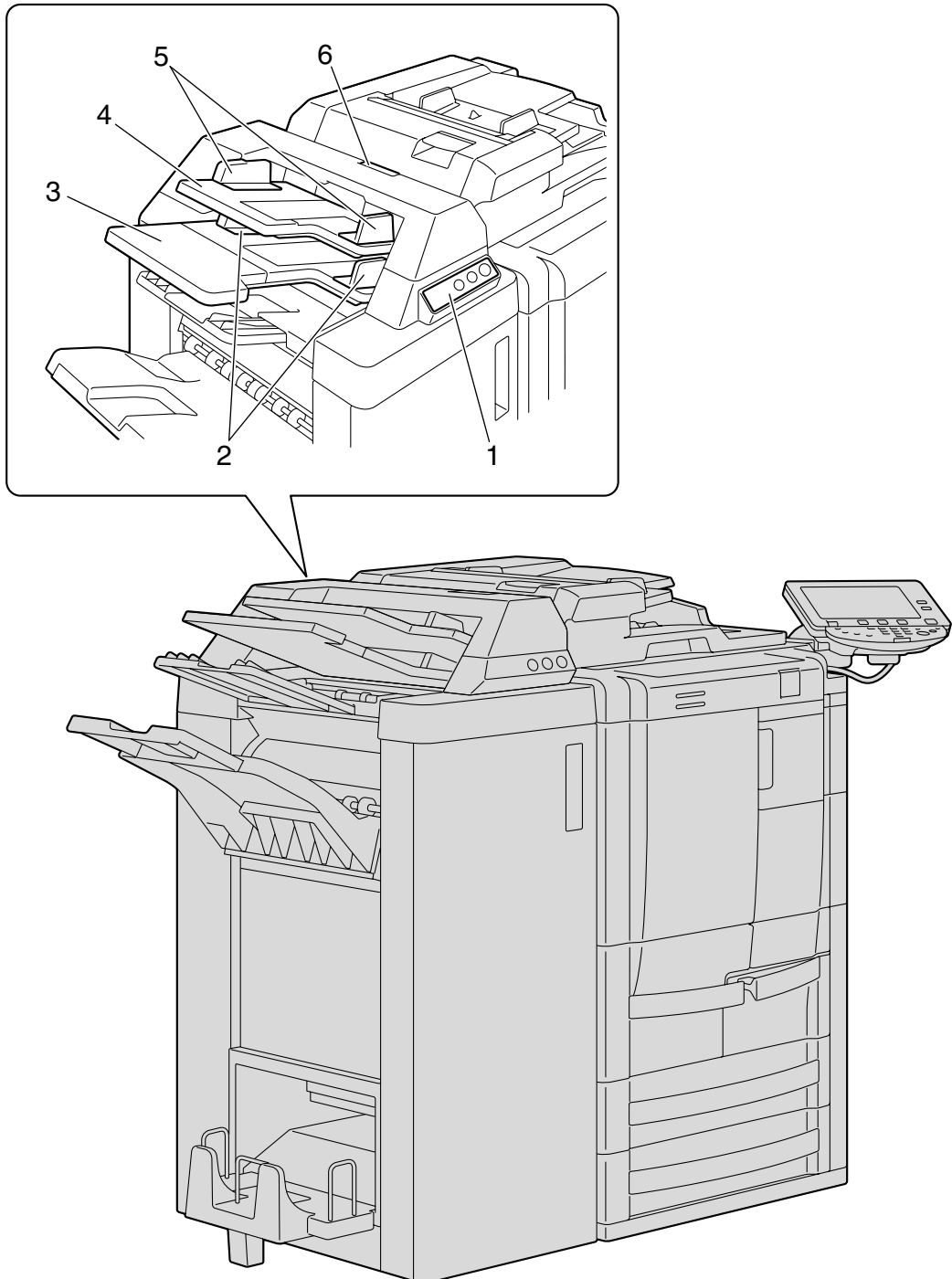

No.	Part name	Description
1	Post inserter control panel	Operate when manually using the finisher. (See p. 2-73 .)
2	Lower tray paper guide	Slide to fit the size of paper being loaded when loading with cover sheets.
3	Lower tray	Load with cover sheets.
4	Upper tray	Load with cover sheets.
5	Upper tray paper guide	Slide to fit the size of paper being loaded when loading with cover sheets.
6	Upper unit release lever	Raised to slide the upper unit to the left when clearing paper misfeeds.

1.1.11 Shift Tray SF-602

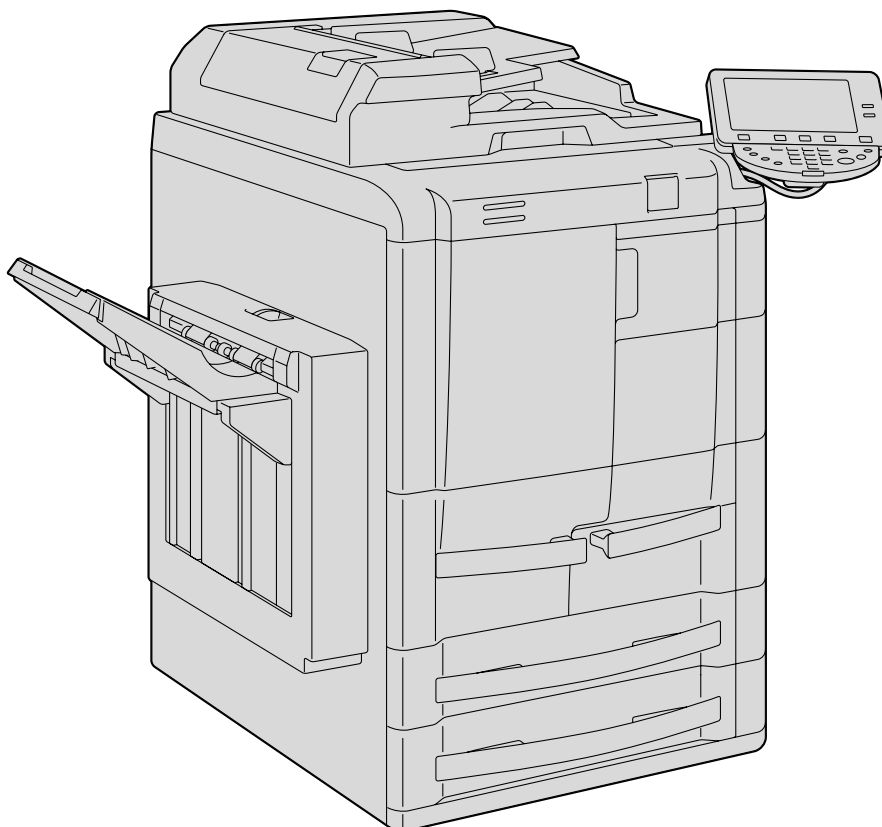

1.1.12 Output Tray OT-505

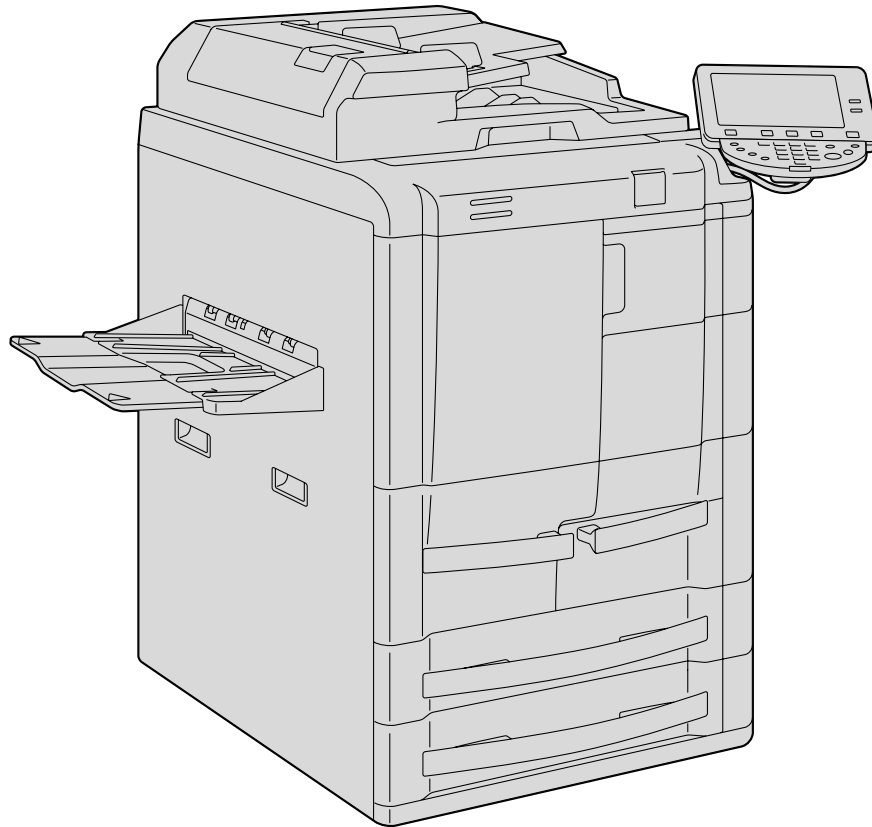

1.1.13 Authentication Unit (Biometric Type) AU-101

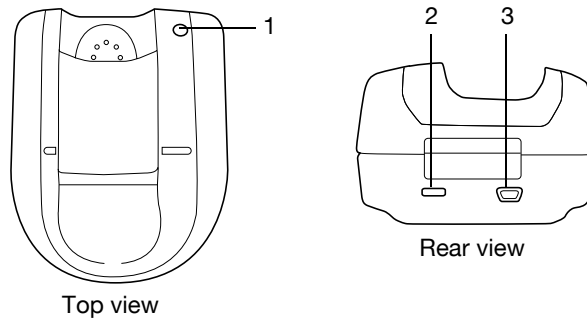

No.	Part name	Description
1	Status indicator	Indicates the status of the authentication unit.
2	Security slot	Used for connecting the security cable to prevent thefts. (complies with the security cable standards of the Kensington Computer Products Group)
3	USB port (type mini-B)	Used to connect a USB cable (mini-B plug).

1.1.14 Authentication Unit (IC Card Type) AU-201

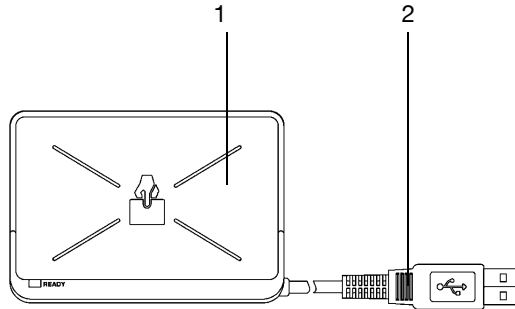

No.	Part name	Description
1	Card scanning area	Position the IC card on this area.
2	USB cable	Used for connecting this device to the machine.

Precautions for using the finisher:

- Do not place objects on top of the finisher and below the paper output trays, otherwise the machine may be damaged.

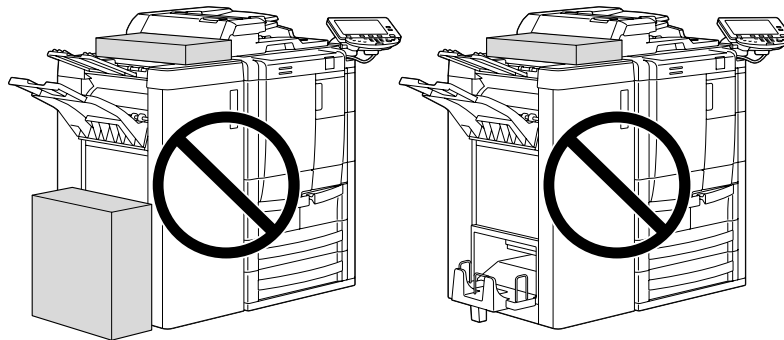

1.1.15 Control panel

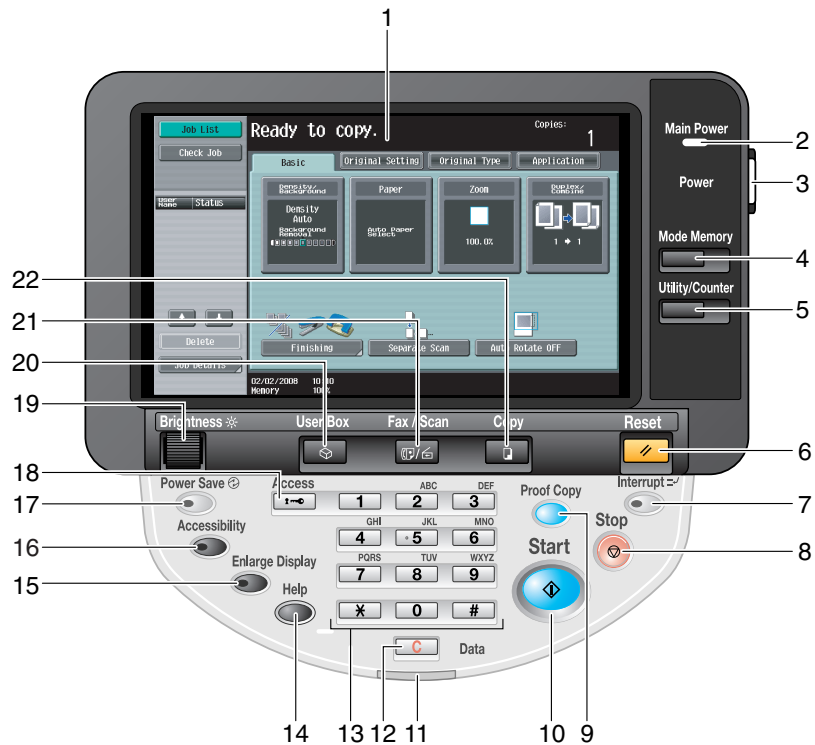

No.	Part name	Description
1	Touch panel	Displays various screens and messages. Specify the various settings by directly touching the panel.
2	Main Power indicator	Lights up in green when the machine is turned on with the main power switch.
3	[Power] (auxiliary power) key	Press to turn on/off machine operations. When turned off, the machine enters a state where it conserves energy.
4	[Mode Memory] key	Press to register (store) the desired copy/fax/scan settings as a program or to recall a registered program. (See p. 3-8 .)
5	[Utility/Counter] key	Press to display the Meter Count screen and the Utility screen.
6	[Reset] key	Press to clear all settings (except programmed settings) entered in the control panel and touch panel.
7	[Interrupt] key	Press to enter Interrupt mode. While the machine is in Interrupt mode, the indicator on the [Interrupt] key lights up in green and the message "Now in Interrupt mode." appears on the touch panel. To cancel Interrupt mode, press the [Interrupt] key again.
8	[Stop] key	Pressing the [Stop] key while copying, scanning or printing temporarily stops the operation.
9	[Proof Copy] key	Press to print a single proof copy to be checked before printing a large number of copies. (See p. 3-5 .)
10	[Start] key	Press to start the copy, scan or fax operation. When this machine is ready to begin the operation, the indicator on the [Start] key lights up in blue. If the indicator on the [Start] key lights up in orange, copying cannot begin. Press to restart a stopped job. For details on jobs, refer to " Overview of Job List screen " on page 10-2 .
11	Data indicator	Flashes in blue while a print job is being received. Lights up in blue when a print job is queued to be printed or while it is being printed. The indicator lights up in blue when there is saved fax data or unprinted fax data.
12	[C] (clear) key	Press to clear a value (such as the number of copies, a zoom ratio, or a size) entered using the keypad.
13	Keypad	Use to type in the number of copies to be produced. Use to type in the zoom ratio. Use to type in the various settings.
14	[Help] key	Press to display the Help Menu screen. From this screen, descriptions of the various functions and details of operations can be displayed. (See p. 3-13 .)
15	[Enlarge Display] key	Press to enter Enlarge Display mode.
16	[Accessibility] key	Press to display the screen for specifying settings for user accessibility functions.
17	[Power Save] key	Press to enter Power Save mode. While the machine is in Power Save mode, the indicator on the [Power Save] key lights up in green and the touch panel goes off. To cancel Power Save mode, press the [Power Save] key again.
18	[Access] key	If user authentication or account track settings have been applied, press this key after entering the user name and password (for user authentication) or the account name and password (for account track) in order to use this machine.
19	[Brightness] dial	Use to adjust the Brightness of the touch panel.
20	[User Box] key	Press to enter User Box mode. While the machine is in User Box mode, the indicator on the [User Box] key lights up in green. For details, refer to the User's Guide [Box Operations].
21	[Fax/Scan] key	Press to enter Fax/Scan mode. While the machine is in Fax/Scan mode, the indicator on the [Fax/Scan] key lights up in green. For more details, refer to the User's Guide [Network Scan/Fax/Network Fax Operations].
22	[Copy] key	Press to enter Copy mode. (As a default, the machine is in Copy mode.) While the machine is in Copy mode, the indicator on the [Copy] key lights up in green.



Reminder

Do not apply extreme pressure to the touch panel, otherwise it may be scratched or damaged.

Never push down on the touch panel with force, and never use a hard or pointed object to make a selection in the touch panel.

1.1.16 Basic settings screens

When the machine is ready to begin making copies after being turned on, the Basic screen appears.

To activate a function or to select a setting, lightly touch the desired button in the touch panel.

Basic screen

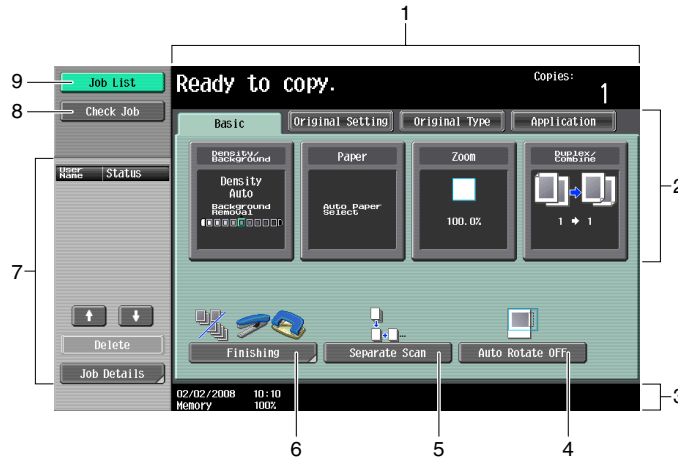

Quick Copy screen

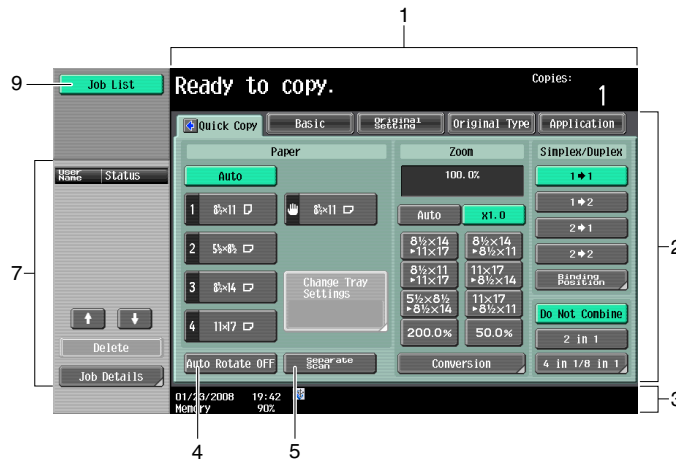

Touching  displays Density settings, Background Removal settings, and [Finishing] in the left panel.



No.	Item Name	Description
1	Message display area	The status of the machine and details on operations are displayed.
2	Functions/settings display area	Tabs and buttons for displaying screens containing various functions are displayed. Touch a tab or button to display the corresponding screen for specifying the settings.
3	Icon display area	Icons indicating the status of jobs and the machine are displayed.
4	[Auto Rotate OFF] button	Touch to copy with the image not rotated to fit the orientation of the loaded paper.
5	[Separate Scan] button	Touch to scan the original in separate batches. An original scanned in different batches can be treated as a single copy job.
6	[Finishing] button	Touch to specify settings for collating, grouping, stapling, or hole punching.
7	Left panel	When the [Job List] button is pressed, a screen showing the jobs currently being performed or waiting to be performed is displayed. When the [Check Job] button is pressed, a screen showing the result of the specified settings is displayed.
8	[Check Job] button	The result of the specified settings is displayed.
9	[Job List] button	Jobs currently being performed or waiting to be performed are displayed. Various commands for checking and managing jobs are available.



Detail

The basic settings screen (Basic screen or Quick Copy screen) that appears can be set with the "Copier Settings" parameter in the Custom Display Settings screen (displayed from the User Setting screen in Utility/Counter mode). The arrangement of the buttons and screens differ with the Basic screen and Quick Copy screen; however, the functions that can be set are the same. As a default, "Basic" is selected. This manual contains descriptions of procedures using the Basic screen that appears when "Basic" is selected.

The Quick Copy screen displays all of the settings from the Basic screen so that many settings can easily be specified.



Detail

For details on switching the basic settings screen, refer to ["Custom Display Settings" on page 11-17](#).











Note

If settings have been changed from the factory defaults, the tab for the screen containing the changed settings appears framed with a green line.

The green line can be changed to another color with the "Color Selection Settings" parameter in the Custom Display Settings screen (displayed from the User Setting screen in Utility/Counter mode).

1.1.17 Icons that appear in the screen

Icon	Description
	Indicates that data is being sent from the machine, regardless of the current mode.
	Indicates that data is being received from the machine, regardless of the current mode.
	If the warning screen was closed when a warning occurred, touch this button to display the warning screen again.
	Appears when there is a message indicating that consumables must be replaced or the machine requires maintenance. Touch this icon to display the message, and then perform the replacement or maintenance procedure.
	Appears when an error occurs with the connection to the POP server.
	Indicates that paper is not loaded in the paper tray.
	Indicates that very little paper remains in the paper tray.
	Indicates that "Enhanced Security Mode" is set to "ON".
	Appears when a USB drive is connected.

1.2 Adjusting the angle of the control panel

The control panel can be adjusted to any of three angles. In addition, the control panel can be tilted to the left. Adjust the control panel to the angle that allows for easy operation.

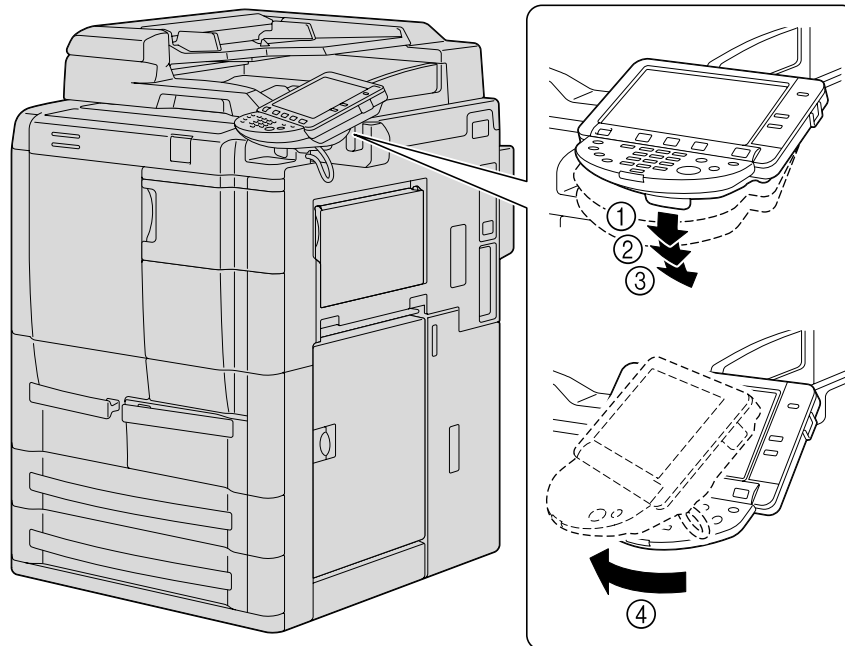

1.2.1 To adjust the angle of the control panel

- 1 Pull the control panel release lever toward you, to release the positioning lock.

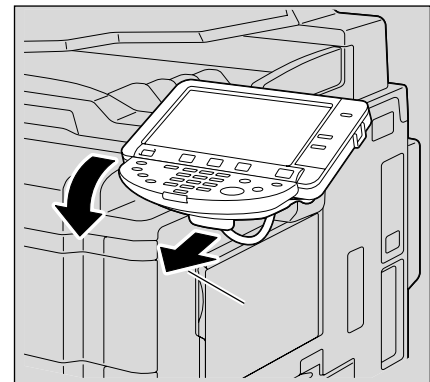

- 2 Move the control panel to the desired position, then release the lever.

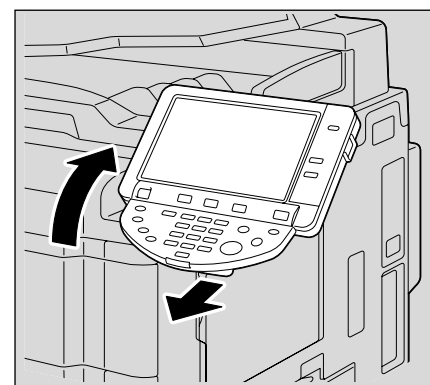

- 3 To tilt the control panel to the left, hold the bottom of the control panel, and then tilt the panel to the left.

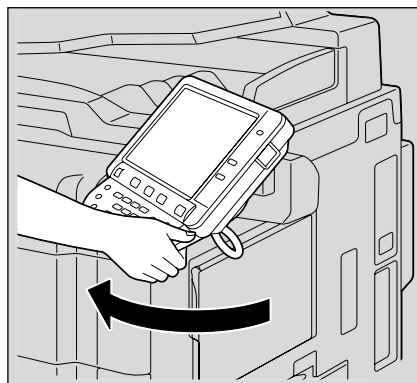

Reminder

When tilting the control panel, do not grab the touch panel or the control panel.

1.3 Turning on the main power and the auxiliary power

This machine has two power controls: the main power switch and the [Power] (auxiliary power) key.

1.3.1 Turning on the machine

The main power switch turns on/off all functions of the machine. Normally, the main power switch is turned on.

The [Power] (auxiliary power) key turns on/off machine operations, for example, for copying, printing or scanning. When the [Power] (auxiliary power) key is turned off, the machine enters a state where it conserves energy.

- 1 Open the front door, and then set the main power switch to "I".

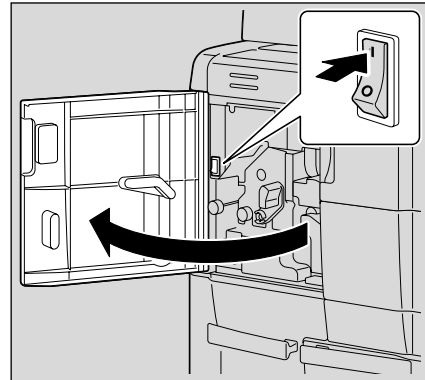

- 2 Close the front door.
- 3 Press the [Power] (auxiliary power) key.
Check that the touch panel is turned on.

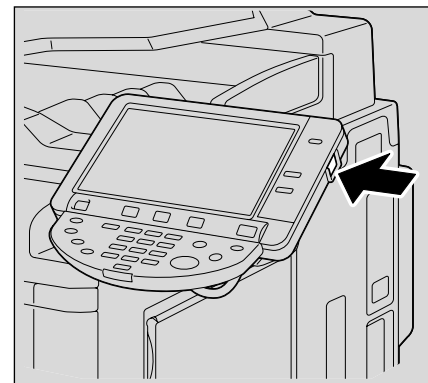

Detail

When the [Power] (auxiliary power) key is turned on, the indicator on the [Start] key lights up in orange, and a screen indicating that the machine is starting up appears.

After a few seconds, the message "Warming up. Ready to scan." appears on the touch panel, and the indicator on the [Start] key lights up in blue, indicating that a job can now be queued.

The default settings are the settings that are selected immediately after the machine is turned on (the power switch is set to "I") and before any setting is specified from the control panel or touch panel, and those that are selected when the [Reset] key is pressed to cancel all settings specified from the control panel or touch panel. The default settings can be changed. For more details, refer to "[Custom Display Settings](#)" on page 11-17.

The factory default settings are the settings that were selected when this machine was sent from the factory.

**Note**

A job can also be queued while the machine is warming up after the [Power] (auxiliary power) key is turned on. For details, refer to ["Scanning during warm-up" on page 1-30](#). After the machine has finished warming up, the scanned image will be printed. Refer to ["Main unit" on page 5-2](#) for warm up time.

1.3.2 Scanning during warm-up

- 1 Press the [Power] (auxiliary power) key.
 - For details on turning on the machine, refer to ["Turning off the machine" on page 1-31](#). The indicator on the [Start] key lights up in orange. After the warm-up message is displayed, the Basic screen appears. The indicator on the [Start] key lights up in blue.
- 2 Check that the message "Warming up. Ready to scan." appears on the touch panel.

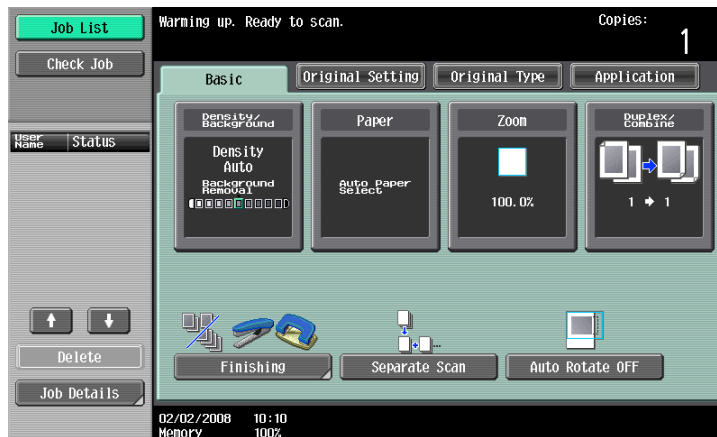

- 3 Position the original to be copied.
 - For details on positioning the original, refer to ["Feeding the original" on page 2-6](#).
- 4 Specify any other desired copy settings.
- 5 Using the keypad, specify the desired number of copies.
 - For details on specifying the number of copies, refer to ["General copy operation" on page 2-2](#).
- 6 Press the [Start] key.
 - The original is scanned, and the job is added to the list of queued jobs.
 - If the "Copy Operating Screen" parameter in Utility mode was set to "Yes", touch [Next Copy Job] to display the Basic screen.

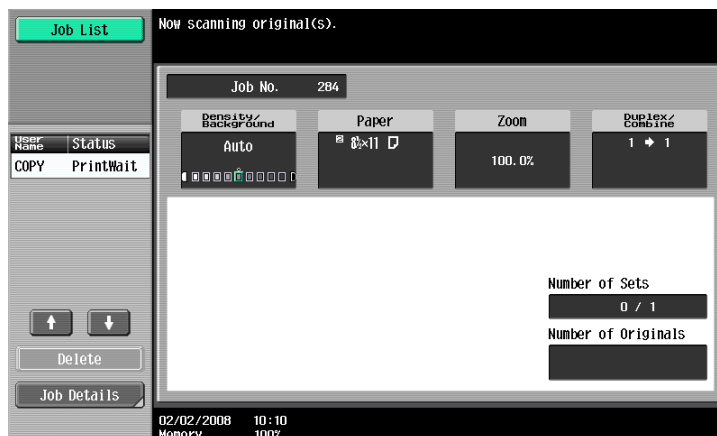

- After the machine has finished warming up, the jobs will automatically be printed.

? How can the job being printed be stopped?

→ Press the [Stop] key. For details, refer to "[Temporarily stopping scanning/printing](#)" on [page 2-78](#).



Detail

While the machine is warming up to begin printing after it is turned on using the [Power] (auxiliary power) key, copy settings can be specified and an original can be scanned to reserve a copy job. After the machine has finished warming up, the copies are automatically printed.

The print order can be changed or jobs can be deleted from the Detail screen of a job from the Current Jobs list in the Job List screen. For details, refer to "[Managing jobs](#)" on [page 10-2](#).

1.3.3 Turning off the machine

- 1 Press the [Power] (auxiliary power) key.
Check that the touch panel is turned off.
- 2 Open the front door, and then set the main power switch to "O".

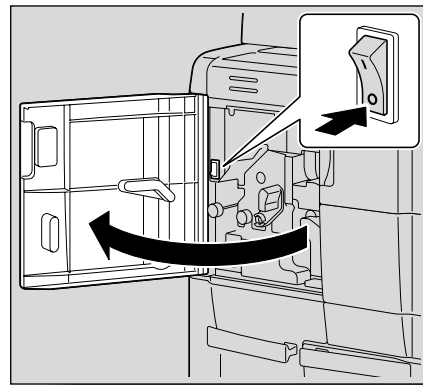

- 3 Close the front door.



Reminder

When the machine is turned off, then on again with the main power switch, wait at least 10 seconds to turn the machine on after turning it off. The machine may not operate correctly if it is turned on immediately after being turned off.

Do not turn off the machine with the main power switch or the [Power] (auxiliary power) key while it is making copies or printing, otherwise a paper misfeed may occur.

Do not turn off the machine with the main power switch or the [Power] (auxiliary power) key while it is scanning or sending or receiving data, otherwise all scan data or transmission data will be deleted.

Do not turn off the machine with the main power switch while a queued job or stored data is waiting to be printed, otherwise the jobs will be deleted.



Detail

The following are cleared when the main power switch and [Power] (auxiliary power) key are turned off.
Settings that have not been programmed
Jobs queued to be printed

1.3.4 Automatically clearing settings (automatic panel reset)

If no operation is performed for a specified length of time (even if the [Reset] key is not pressed), settings that have not been programmed, such as the number of copies, are cleared and return to their default settings.

This is the automatic panel reset operation.

As the factory default, the automatic panel reset operation is performed after 1 minute.

**Detail**

The length of time until the automatic panel reset operation is performed and whether or not it is performed can be set from Utility mode. For details, refer to "System Settings" on page 11-23.

Whether or not the automatic panel reset operation is performed when there is a change of user can be set from the Utility mode. For details, refer to "System Settings" on page 11-23.

1.3.5 Automatically canceling the mode screen (System Auto Reset)

If no operation is performed for a specified length of time, the screen is automatically changed to that for the mode given priority.

This is the System Auto Reset operation.

As the factory default, the Copy mode screen is displayed after 1 minute.

**Detail**

The mode screen that is displayed when the System Auto Reset operation is performed can be changed from the Utility mode. For details, refer to "System Settings" on page 11-23.

1.3.6 Automatically conserving energy (Low Power mode)

If no operation is performed for a specified length of time, the touch panel goes off and the machine automatically enters a mode where it conserves energy.

This is the Low Power mode.

The machine can receive jobs even while it is in Low Power mode.

As the factory default, the machine enters Low Power mode after 15 minutes.

To recover from Low Power mode

- 1 Press the [Power Save] key.



- 2 The machine can receive jobs while it is warming up.
 - The touch panel comes on again and, after the machine has finished warming up, it is ready to begin printing.

**Note**

As the factory default, pressing the [Power Save] key causes the machine to enter Low Power mode. Settings in the Administrator Settings mode can be changed to put the machine in Sleep mode instead. For details, refer to "System Settings" on page 11-23.

The Low Power mode can also be canceled by pressing any key in the control panel or by touching the touch panel.

**Detail**

The length of time until the machine enters Low Power mode can be changed. For details, refer to "System Settings" on page 11-15 and page 11-23.

1.3.7 Automatically conserving energy (Sleep mode)

If no operation is performed for a specified length of time, the machine automatically enters a mode where it conserves energy.

Although the machine conserves more energy in Sleep mode than in Low Power mode, the machine must warm up when Sleep mode is canceled to begin printing again, therefore taking more preparation time than Low Power mode.

As the factory default, the machine enters Sleep mode after 60 minutes.

To recover from Sleep mode

- 1 Press the [Power Save] key.



- 2 The machine can receive jobs while it is warming up.
 - The touch panel comes on again and, after the machine has finished warming up, it is ready to begin printing.



Note

The Sleep mode can also be canceled by pressing any key in the control panel or by touching the touch panel.



Detail

As a default, the machine enters Low Power mode if no operation is performed for 15 minutes, and then the machine enters Sleep mode after 60 minutes have elapsed.

The length of time until the machine enters Sleep mode can be changed. For details, refer to "[System Settings](#)" on page 11-15 and "[System Settings](#)" on page 11-23.

1.3.8 Manually conserving energy

The machine can be manually set to an energy conservation mode (Low Power mode or Sleep mode).

- 1 Press the [Power Save] key (or press the [Power] (auxiliary power) key).
 - As the factory default, the machine enters Low Power mode.



Detail

Whether the machine enters Low Power mode or Sleep mode when the [Power Save] key is pressed can be set from the Administrator Settings mode.

For details, refer to "[System Settings](#)" on page 11-23.

1.3.9 Automatically turning the machine on/off (Weekly Timer)

The machine can be set to automatically enter Sleep mode according to a usage schedule determined by the administrator so the machine's use can be limited.

This is the Weekly Timer.

Follow the procedure described below to use the machine while the Weekly Timer is being used.



Detail

As the factory default, the Weekly Timer is not set. For details on setting the Weekly Timer, refer to "[System Settings](#)" on page 11-23.

- 1 Press the [Power Save] key.



- 2 Type in the password (up to 8 digits) for non-business hours.



- For details on setting the password for non-business hours, refer to "[System Settings](#)" on page 11-23.

- 3 Touch [OK].
The message "It is now non-business hour. Set the Sleep Mode time." appears.
- 4 Using the keypad, again type in the length of time until the machine enters Sleep mode.

- Specify a length of time between 5 minutes and 9 hours and 59 minutes.



? How can a single digit be entered?

→ First, type in "0". If a minutes setting of less than 5 is entered, the setting changes to 5 minutes. In addition, a minutes setting of 60 or more cannot be specified.

5 Touch [OK].

The message "Ready to copy." appears on the touch panel.



Note

If the message "It is now non-business hour. Set the Sleep Mode time." or "It is now non-business hour. To use the device, enter password using the keyboard or keypad and then touch [OK]." appears after the [Power] (auxiliary power) key is pressed, the Weekly Timer is set.



Detail

During the set time, the copy operations can be performed as usual.

From the Password for Non-Business Hours screen (displayed from Administrator Settings mode), the machine can be set so that the screen for entering the password for non-business hours is not displayed.

The default setting for the "Password for Non-Business Hours" parameter is "No" (the screen is not displayed).

1.3.10 Controlling each user's use of this machine (User Authentication)

If user authentication settings have been specified by the administrator, only users that have been registered can use this machine. In addition, the number of printed pages can be managed for each user.

- ✓ When user authentication settings have been specified, only users who enter passwords for specified users can use this machine.
- ✓ Contact the administrator for a user name and password and for the server name.
- ✓ If machine authentication or external server authentication has been set, a total of 1,000 users and accounts can be registered.

1 Touch [User Name].



- If a list of user names can be displayed, the desired user name can be selected from the list. Touch [User Name List], touch the button for the desired user name to select it, and then touch [OK].
- Users who have no access to a user name and password can touch [Public User Access] to use this machine. For details on specifying public user settings, refer to ["Selecting an authentication method" on page 11-60](#) and ["Public User Access" on page 11-66](#).
- If "Enhanced Security Mode" is set to "ON", [Public User Access] and [User Name List] do not appear.



- If external server authentication was selected as the user authentication method, [Server Name] appears with the name of the default server. Touch [Server Name] to display the names of the registered servers, and then select the desired server. For details on specifying settings for an external server authentication, refer to ["Selecting an authentication method" on page 11-60](#).

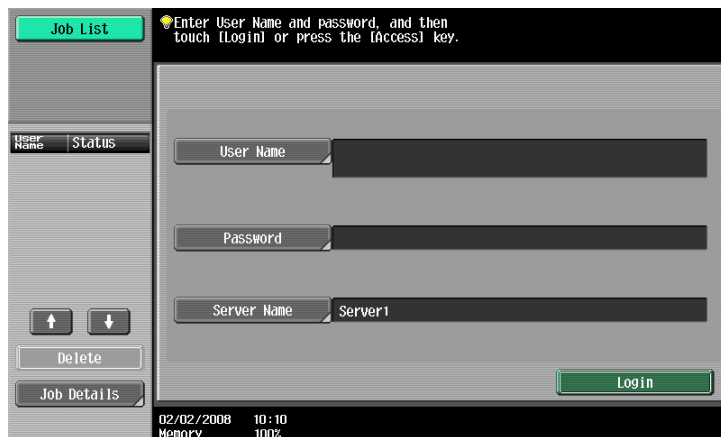

- 2 Type in the user name, and then touch [OK].



- 3 Touch [Password].



- 4 Type in the password, and then touch [OK].



- 5 Touch [Login] or press the [Access] key.

The Basic screen appears.

If account track settings have been applied, the account track screen appears. However, if "Synchronize User Authentication & Account Track" has been set to "Synchronize", the account track screen does not appear if the users and accounts are synchronized.

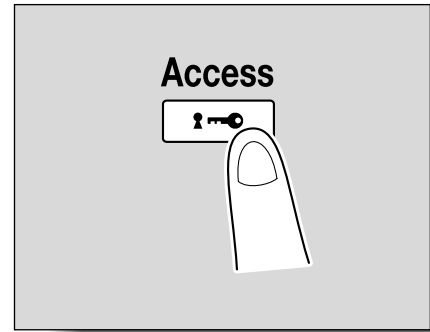

- 6 Make copies using the desired copy settings.

- 7 When you are finished printing, press the [Access] key.

A message appears, requesting confirmation to log off.

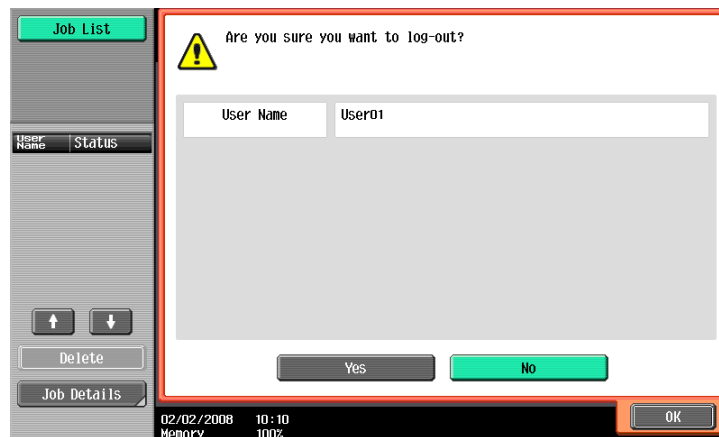

- 8 Touch [Yes], and then touch [OK].

The user authentication screen appears.



Detail

For details on specifying user authentication settings, refer to "[User Authentication/Account Track](#)" on page 11-29.



Note

The user authentication settings can be used together with the account track settings. If the "Synchronize User Authentication & Account Track" parameter is set to "Synchronize", complete user authentication, and then log on by using the account track screen.

User authentication settings can be specified using the User Authentication parameters in Administrator Settings mode, available from the Utility mode. Settings should be specified by the administrator.

1.3.11 Controlling each account's use of this machine (Account Track)

If the account track settings have been specified by the administrator, only users of registered accounts can use this machine. In addition, the number of prints produced with each account can be controlled.

This is account track.

- ✓ When account track settings have been specified, only users who enter passwords for specified accounts can use this machine.
- ✓ If you do not know the account name or password, contact your administrator.
- ✓ A total of 1,000 users and accounts can be registered.

1 Touch [Account Name].



- If the Administrator Settings mode settings have been set to "Password Only", touch [Password], and then continue with step 4.



2 Type in the account name, and then touch [OK].



- 3 Touch [Password].



- 4 Type in the password, and then touch [OK].



- 5 Touch [Login] or press the [Access] key.
The Basic screen appears.

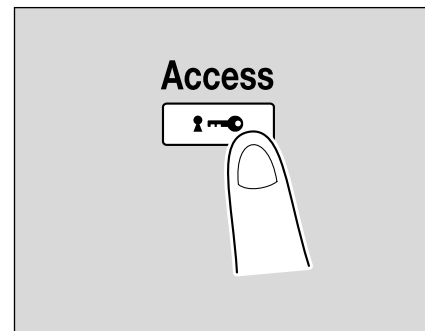

- 6 Make copies using the desired copy settings.

- 7 When you are finished printing, press the [Access] key.
A message appears, requesting confirmation to log off.

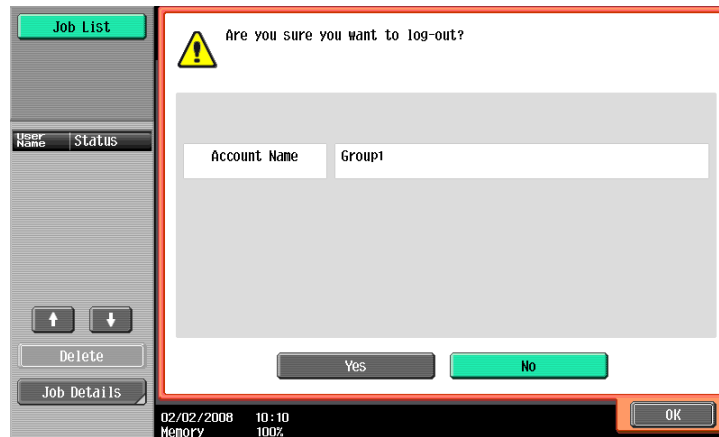

- 8 Touch [Yes], and then touch [OK].
The account track screen appears.



Detail

The accounts can be managed in Administrator Settings mode, available from the Utility mode. Settings should be specified by the administrator.

If "Account Track Input Method" on the General Settings screen of Administrator Settings mode was set to "Password Only", log on is possible by only entering the password. For details, refer to "[User Authentication/Account Track](#)" on page 11-29.

For details on specifying account track settings, refer to "[Selecting an authentication method](#)" on page 11-60.

1.3.12 Controlling use of this machine with authentication unit (biometric type)

An authentication unit (biometric type) can be used with this machine to perform authentication. The authentication unit (biometric type) authenticates the user by scanning the vein patterns in the finger.



...

Note

1-to-many authentication: Authentication is performed simply by positioning the finger.

1-to-1 authentication: Authentication is performed by typing in the user name and positioning the finger.



Detail

To use biometric authentication, register the vein patterns in the finger in advance.

For details on specifying authentication settings for the authentication unit (biometric type) and on registering finger vein patterns, refer to chapter 12, "Authentication Unit (Biometric Type AU-101)" of this manual.

When "1-to-many authentication" has been specified



- Place your finger on the authentication unit (biometric type).

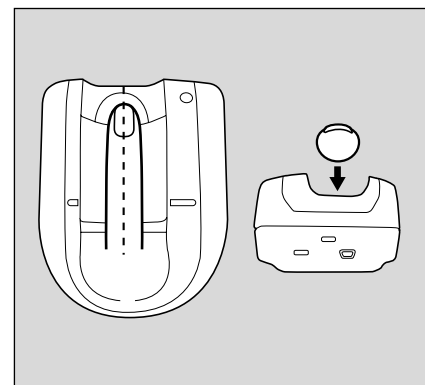

The basic screen appears.

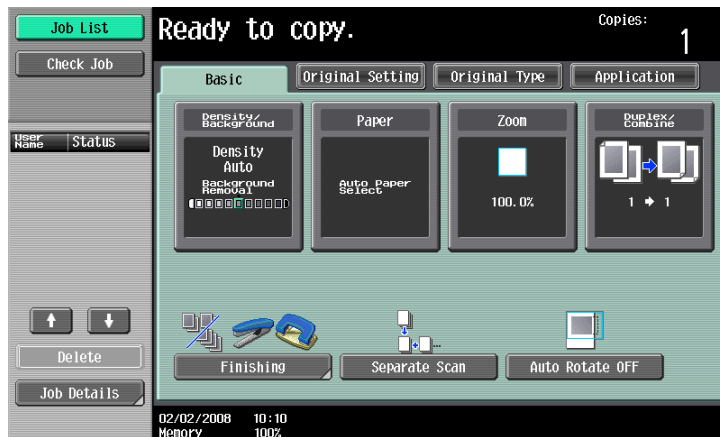

When "1-to-1 authentication" has been specified

- 1 Type in the user name.



- 2 Place your finger on the authentication unit (biometric type).

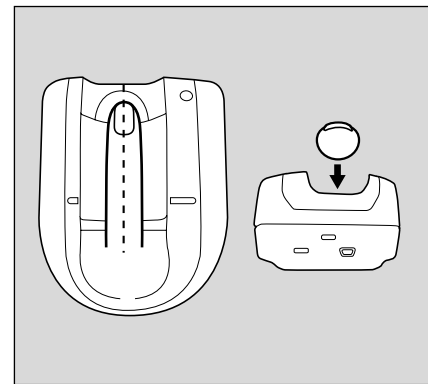

The basic screen appears.

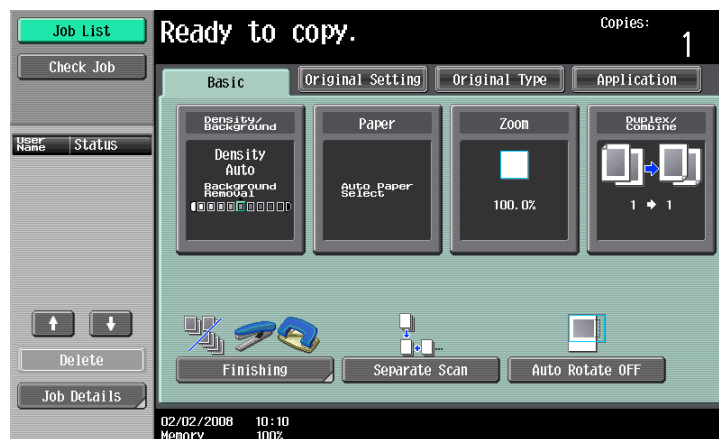

Note

If the authentication unit (biometric type) cannot be used, it is possible to use this machine by entering a [User name] and [Password].

1.3.13 Controlling use of this machine with the authentication unit (IC card type)

An authentication unit (IC card type) can be used with this machine to perform authentication. The authentication unit (IC card type) authenticates users by reading the information registered on their IC card.



Note

Card Authentication: Authentication is performed simply by positioning the IC card.

Card Authentication + Password: Authentication is performed by positioning the IC card and entering the password.



Detail

To use card authentication, register the card information in advance.

For details on specifying authentication settings for the authentication unit (IC card type) and on registering IC card information, refer to chapter 13, "Authentication Unit (IC Card Type AU-201)" of this manual.

When "Card Authentication" has been specified



- Place the IC card horizontally on the card scanning area of the authentication unit (IC card type).

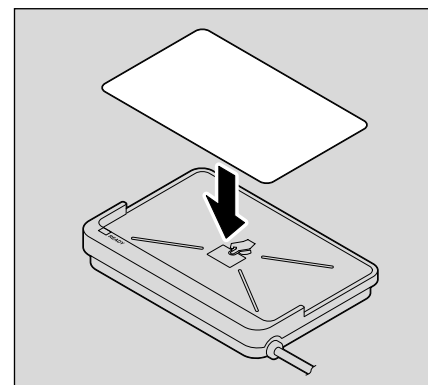

The Basic screen appears.

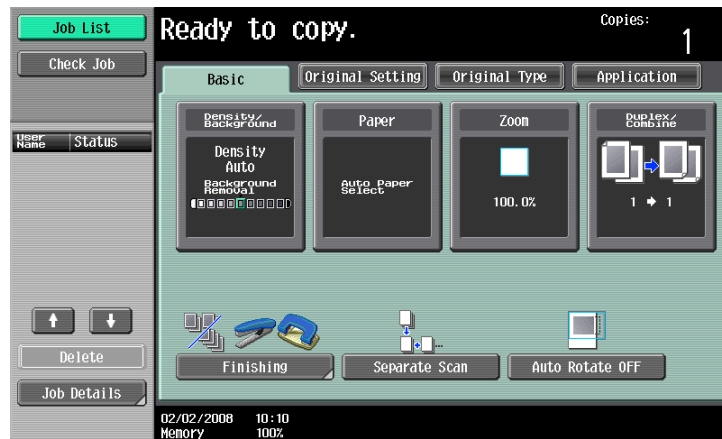

When "Card Authentication + Password" has been specified



- 1 Place the IC card horizontally on the card scanning area of the authentication unit (IC card type).

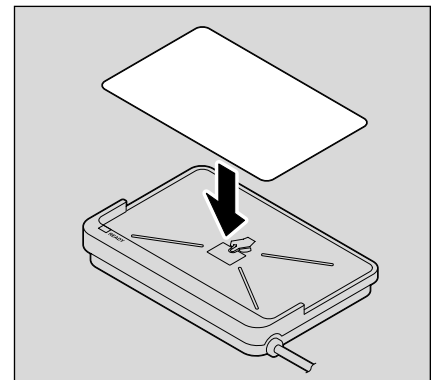

- 2 Type in the password and then touch [Login] or press the [Access] key.

The Basic screen appears.

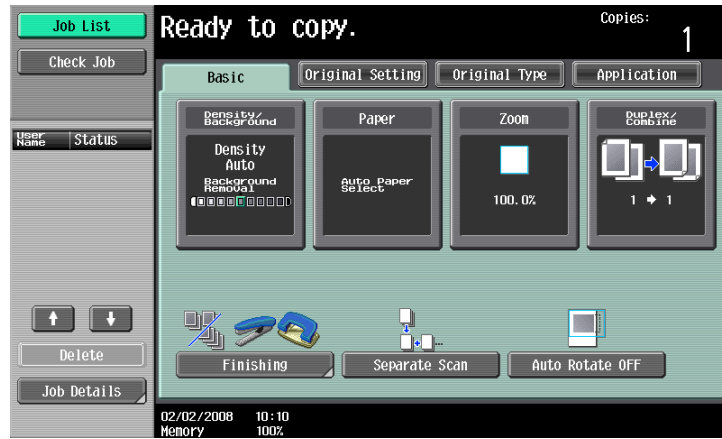

...

Note

If the authentication unit (IC card type) cannot be used, it is possible to use this machine by entering a user name and password.

1.4 Loading paper into the tray 1 or 2

To load paper (tray 1 or 2)

- 1 Pull out the tray 1 or 2.
- 2 Raise the paper take-up roller.

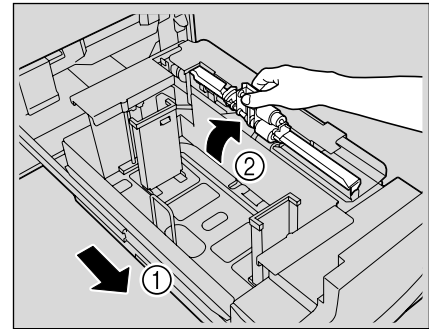

- 3 Load the paper into the tray.
 - Load the paper so that it is flush against the right side of the tray.

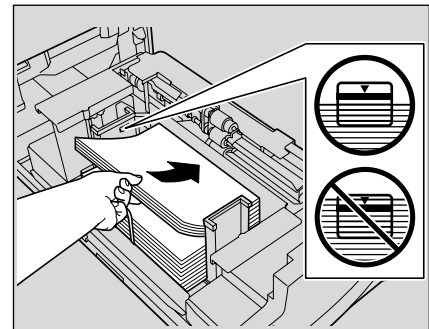

- 4 Fully push in the paper tray.

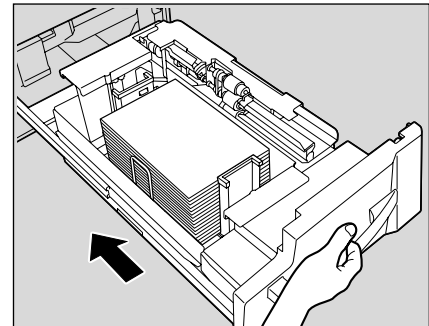

Reminder

Do not load so much paper that the top of the stack is higher than the ▼ mark.

Make sure that the trailing-edge guide is adjusted to fit the size of the loaded paper.

If there is space between the trailing-edge guide and the paper, the paper will not be fed correctly.

Do not close the paper tray with too much force, otherwise the weight of the tray and paper will apply an impact to the machine that may cause damage.

1.5 Loading paper into the tray 3 or 4

To load paper (tray 3 or 4)

- 1 Pull out the tray 3 or 4.
- 2 Raise the paper take-up roller.

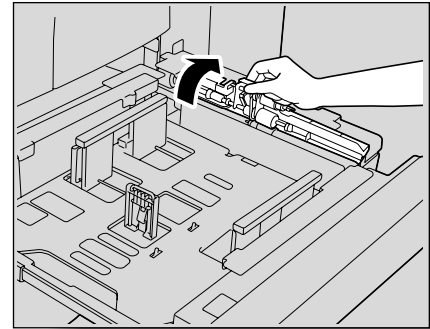

- 3 Load the paper into the tray.
 - Load the paper so that it is flush against the right side of the tray.

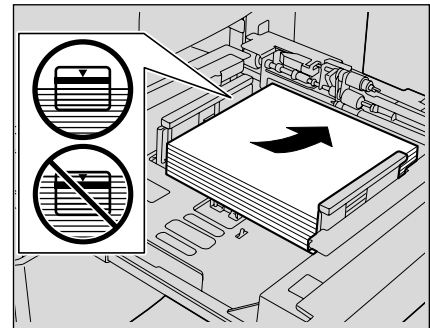

- 4 Slide the lateral guide to fit the size of paper being loaded.
 - Move the lateral guide while holding the release button pressed. When the button is released, the guide is locked in place.

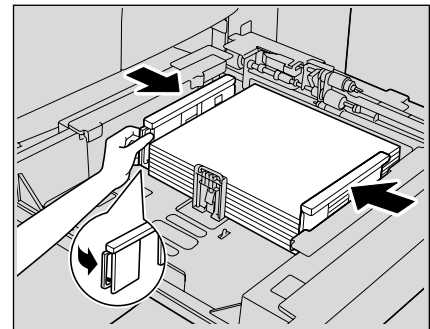

- 5 Fully push in the paper tray.



Reminder

Do not load so much paper that the top of the stack is higher than the ▼ mark.

**Reminder**

Make sure that the trailing-edge guide is adjusted to fit the size of the loaded paper.

If there is space between the trailing-edge guide and the paper or if the trailing-edge guide is not correctly positioned, the paper will not be fed correctly.

Make sure that the lateral guide is correctly positioned against the edge of the loaded paper. If the lateral guide is not positioned correctly, the paper size will not be correctly detected or the punched holes will not be correctly positioned.

If custom-sized paper is loaded, there may be some space between the paper and the trailing-edge guide. When loading the paper, make sure that it fits well against the right side of the paper tray, not the trailing-edge guide.

**Reminder**

Do not close the paper tray with too much force, otherwise the weight of the tray and paper will apply an impact to the machine that may cause damage.

1.6 Loading paper into the LCT (LU-405/LU-406)



...

Note

LCT is the optional Large Capacity Unit LU-405/LU-406.



...

Reminder

If the machine is turned off, the bottom plate cannot be raised. In addition, the bottom plate cannot be lowered, even after the tray bottom plate lower button is pressed. When loading paper into the LCT, be sure that the machine is turned on with both the main power switch and the auxiliary power key.

To load paper (LCT)

- 1 Open the upper cover.
- 2 Press the tray bottom plate lower button.
 - The tray bottom plate is lowered.

(LU-405)

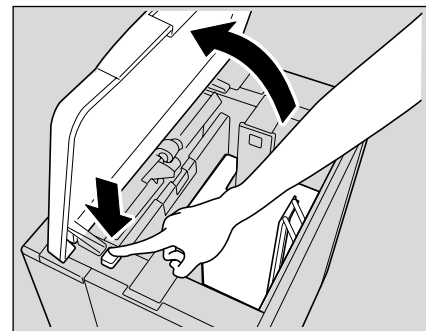

(LU-406)

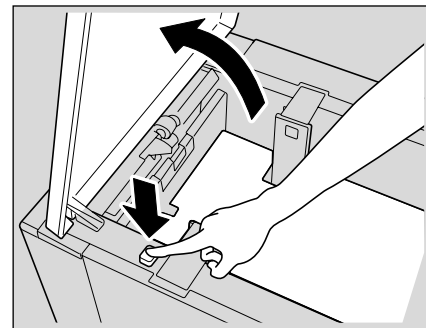

- 3 Load the paper into the tray.

(LU-405)

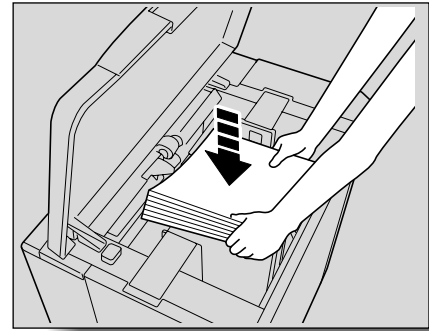

(LU-406)

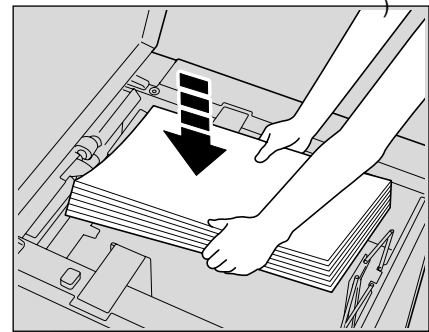

- 4 Repeat steps 2 and 3 until the tray bottom plate cannot be lowered any further.

(LU-405)

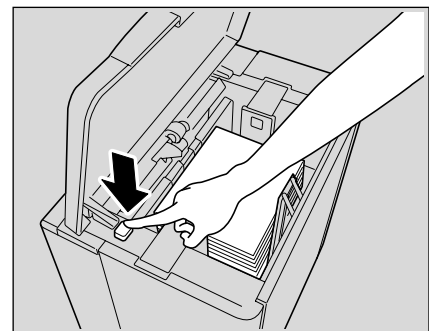

(LU-406)

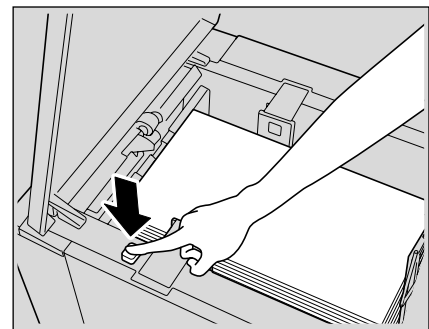

- 5 Close the upper cover.

**Reminder**

Do not load the LCT with paper of other sizes than previously specified.

Do not load so much paper that the top of the stack does not exceed the ▼ mark.

Make sure that the trailing edge stopper is adjusted to fit the size of the loaded paper. If there is space between the trailing edge stopper and the paper, the paper will not be fed correctly.

1.7 Loading paper into the bypass tray

Paper can be fed manually through the bypass tray if you wish to copy onto paper that is not loaded into a paper tray, or if you wish to copy onto thick paper, thin paper, tracing paper, tab paper, OHP transparencies, label sheets, etc.

- 1 Open the bypass tray.

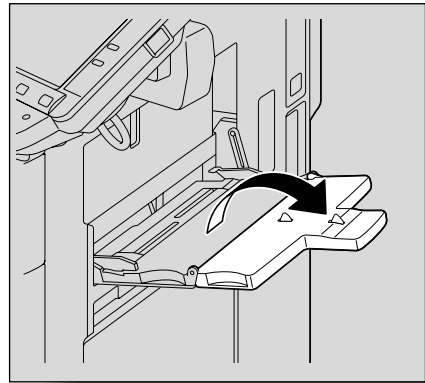
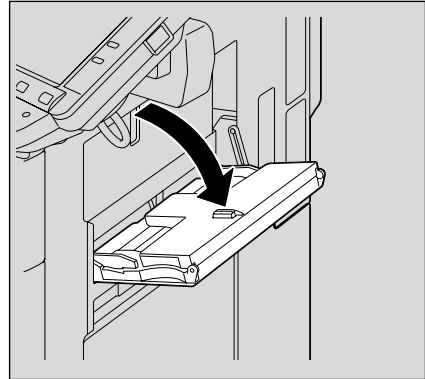

- 2 With the side to be printed on facing down, insert the paper as much as possible into the feed slot.

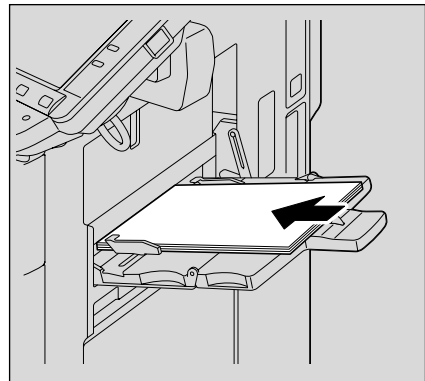

- 3 Slide the lateral guides to fit the size of paper being loaded.
 - Push the paper guides firmly up against the edges of the paper.
 - ? How is curled paper loaded?
→ Flatten the paper before loading it.

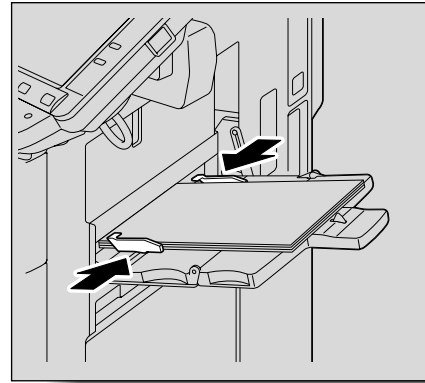

- 4 Select the paper type.

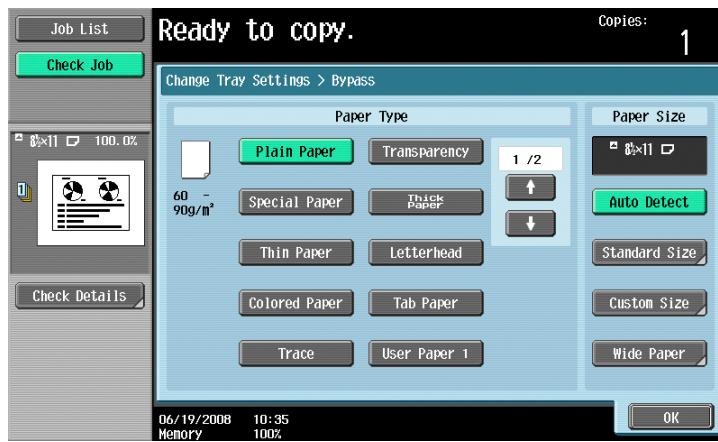

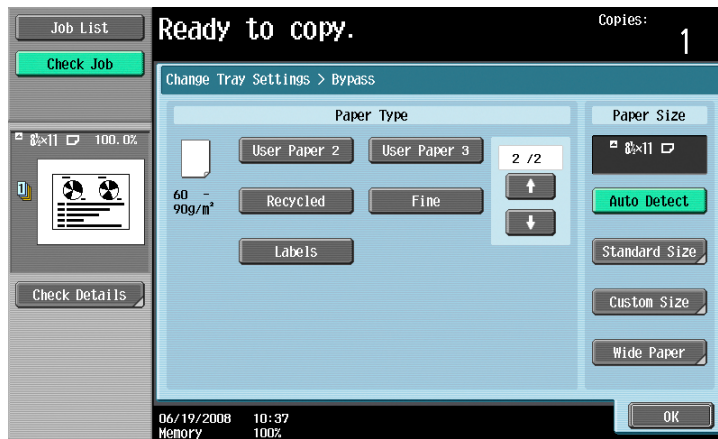

- To display a different list of paper types, touch [↓].



- 5 Touch [OK], and then touch [OK] in the next screen that appears. The Basic screen appears again.





Reminder

When loading OHP transparencies, load them in the  orientation, as shown in the illustration. Do not load OHP transparencies in the  orientation.

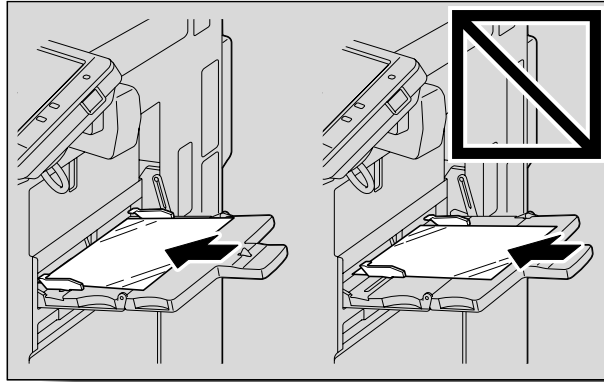
Load OHP transparencies one sheet at a time.



When loading tab papers, load them in the  orientation, as shown in the illustration. Do not load tab papers in the  orientation.

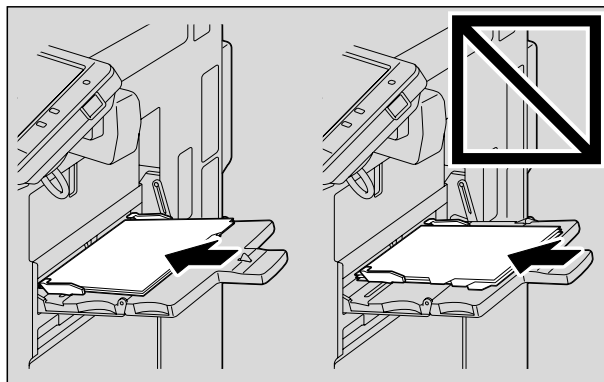

Load label sheets one sheet at a time.

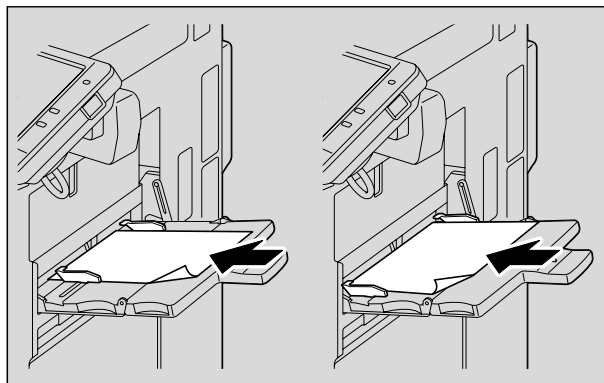

Be sure to load letterhead paper so that the side to be printed on faces up, and select [Letterhead] for the paper type of the bypass tray.

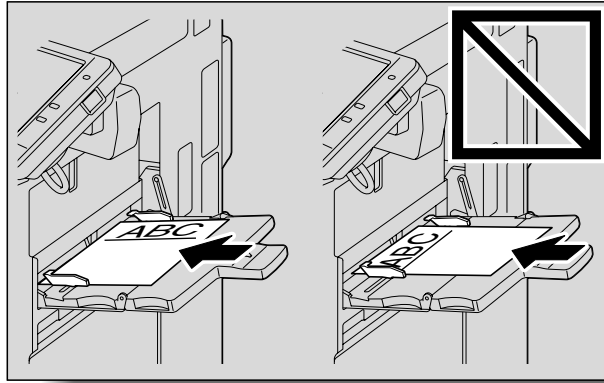
**Note**

The image will be printed on the surface of the paper facing down when the paper is loaded into the bypass tray.

**Detail**

For details on the paper sizes, refer to ["Copy paper" on page 6-2](#).

For details on selecting a setting for standard size paper, refer to ["Selecting a paper size setting \(Size Setting\)" on page 6-10](#).

For details on selecting a setting for non-standard-size paper, refer to ["Specifying a non-standard paper size \(Custom Size settings\)" on page 6-12](#).

For details on selecting a setting for wide paper, refer to ["Selecting a setting for oversized paper \(Wide Paper settings\)" on page 6-16](#).

1.8 Loading paper of a different size into paper trays

The paper loaded into the tray 3 and 4 can be changed to that of a different size.



Note

To load paper of a different size into the tray 1 and 2 and the LCT, contact your service representative.

1.8.1 Changing the size of paper that is loaded

- 1 Pull out the tray 3 or 4.
- 2 Raise the paper take-up roller.
- 3 Remove the trailing-edge guide, and then insert it at the position for the desired paper size.
 - Press the button to remove the trailing-edge guide.

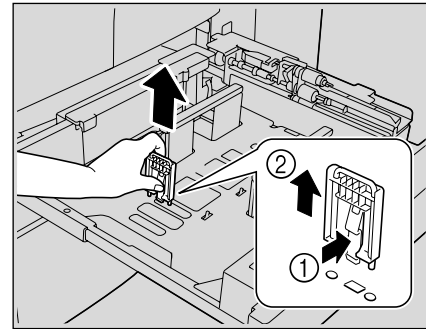

- Insert the trailing-edge guide into the hole corresponding to the size indicated on the bottom plate.

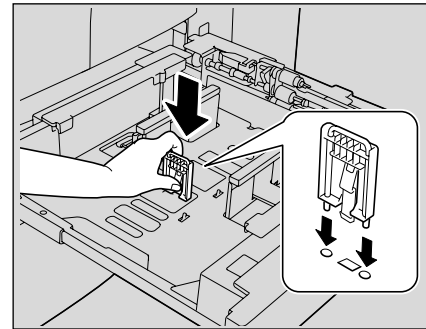

- 4 Load paper of the new size, and then slide the lateral guide to fit the size of the paper.
 - Move the lateral guide while holding the release button pressed. When the button is released, the guide is locked in place.

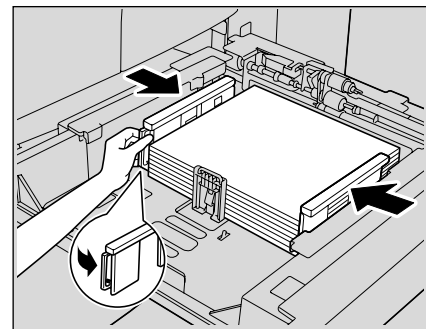

- 5 Fully push in the paper tray.
 - If paper other than standard-size paper or thick paper was loaded, specify the settings for the loaded paper in the Paper Type screen. Refer to "[Paper type setting for a tray](#)" on page 6-20.



Reminder

Be sure to insert the trailing-edge guide at the position for the specified size. If there is space between the trailing-edge guide and the paper, the paper will not be fed correctly.

Make sure that the lateral guide is correctly positioned against the edge of the loaded paper. If the lateral guide is not positioned correctly, the paper size will not be correctly detected.

Do not close the paper tray with too much force, otherwise the weight of the tray and paper will apply an impact to the machine that may cause damage.

1.8.2 When 5-1/2 × 8-1/2 or A5-size thick paper is loaded into a paper tray

If 5-1/2 × 8-1/2 or A5-size thick paper is loaded into a paper tray, the bypass tray or the LCT, the transport lever must be correctly set in order to prevent paper misfeeds.

To set the transport lever

- 1 Open the front doors (left and right).
- 2 Turn lever M4 to the left, and then pull out the ADU unit.

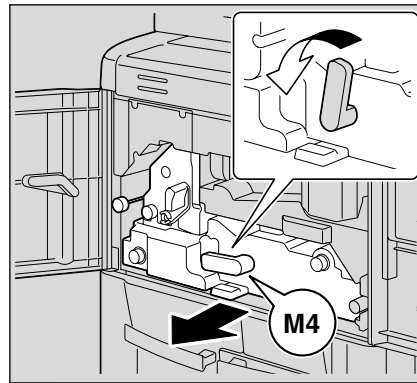

- 3 Set the transport lever to "5-1/2 × 8-1/2, A5 Thick paper".

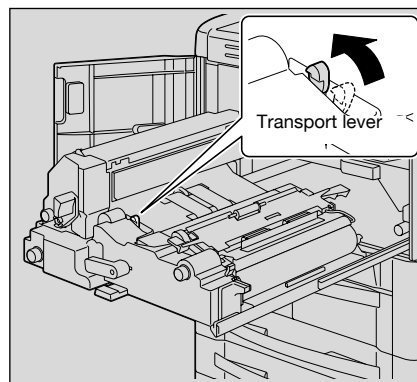

- 4 Return the ADU unit to its original position.
- 5 Close the front doors (left and right).



Note

After using 5-1/2 × 8-1/2 or A5-size thick paper, be sure to reset the transport lever to "NORMAL".



2

Basic copy operations

2 Basic copy operations

2.1 General copy operation

This section contains information on the general operation for making copies.

The following procedure describes how to copy a single-sided original using basic copy operations.



Note

The maximum loading capacity of the output trays for the optional finisher may be limited depending on the paper size and selected Finishing settings.

With continuous printing (multiple jobs), the warning "The output tray has reached its capacity. Remove paper from the tray indicated by →." may appear, even if the paper was removed from the output trays. For details on multiple jobs, refer to "Multi-job feature" on page 10-2.

Interrupting a print job resets the loading capacity of the output tray.

For details on the limitations of the loading capacity for the output trays, refer to "Specifications" on page 5-2.

Some settings cannot be used together. For details on the settings that cannot be combined, refer to "Operations that cannot be combined" on page 2-4.

- 1 Press the [Copy] key to display the Basic screen in Copy mode.
- 2 Position the original to be copied.
 - For details on positioning the original, refer to [page 2-6](#).

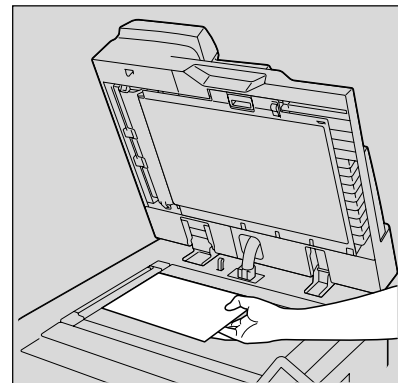
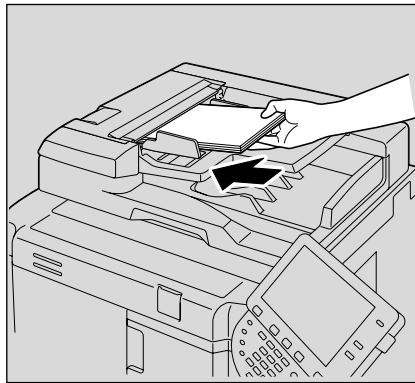

- 3 Specify the desired copy settings.

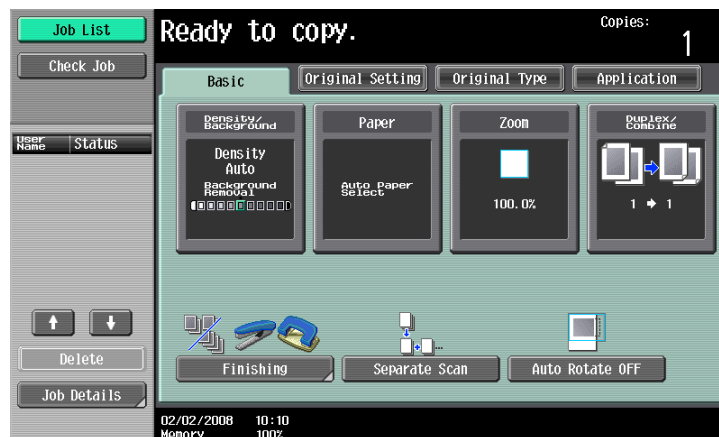

- The factory default settings for this machine are listed below.
 [Density]: Auto
 [Background Removal]: Standard
 [Paper]: Auto (Auto Paper Select)
 [Zoom]: Full Size (100.0%)
 [Duplex/Combine]: 1 > 1
 [Original Type]: Text/Photo
- For details on selecting settings in the Original Setting screen, refer to [page 2-16](#).
- For details on selecting a Paper setting, refer to [page 2-30](#).
- For details on specifying a Zoom setting, refer to [page 2-32](#).
- For details on selecting the original and copy settings, refer to [page 2-42](#).
- For details on selecting the original image quality, refer to [page 2-50](#).
- For details on selecting a copy density setting, refer to [page 2-52](#).
- For details on specifying combined copy settings, refer to [page 2-47](#).
- For details on selecting Finishing settings, refer to [page 2-54](#).
- For details on selecting the Fold/Bind settings, refer to [page 2-65](#).
- For details on specifying settings to not rotate the image, refer to [page 2-76](#).
- For details on specifying settings for the Application functions, refer to [page 7-2](#).

- 4** Using the keypad, type in the desired number of copies.

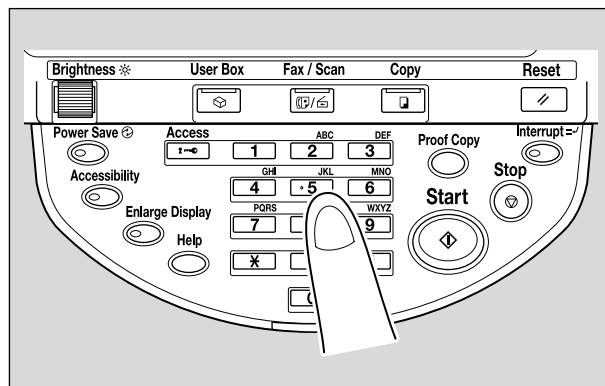

- If the number of copies was incorrectly entered, press the [C] (clear) key in the keypad, and then specify the correct number of copies.

- 5** Press the [Start] key.

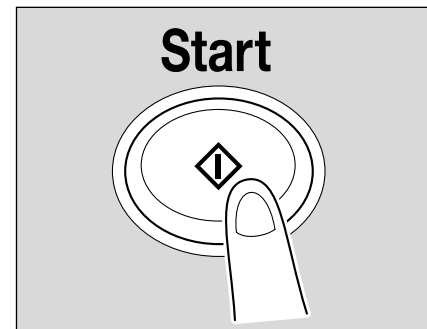

- To stop the copy operation being performed, press the [Stop] key. For details, refer to [page 2-78](#).
- The next copy operation can be queued while a copy operation is being performed. For details, refer to [page 2-77](#).

2.2 Operations that cannot be combined

Certain copy settings cannot be used together.

Specifying settings that cannot be combined will result in one of the following occurring.

- The setting specified last is given priority. (The setting specified first is canceled.)
- The setting specified first is given priority. (A warning message appears.)

2.2.1 Operations where the setting specified last is given priority

The procedure for setting the "Booklet" function after selecting the "2 Position" Staple setting is described below.

- 1 Select the "2 Position" Staple setting.

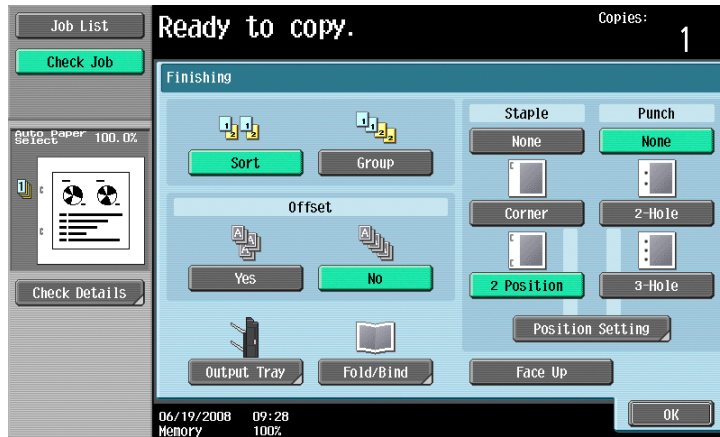

- 2 Set the "Booklet" function.

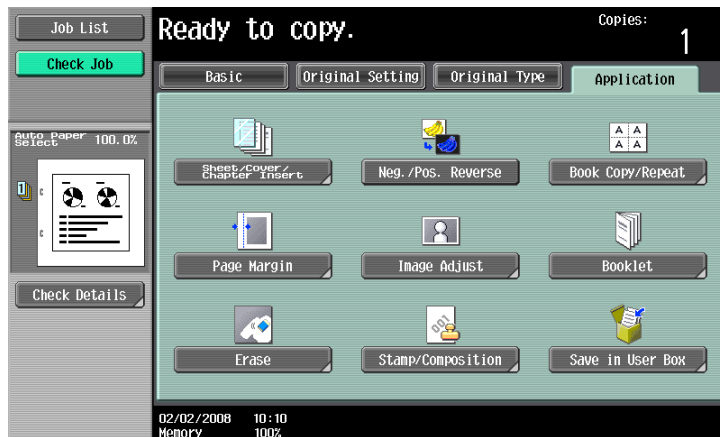

The "2 Position" Staple setting is automatically canceled, and the "Booklet" function is set. To select the "2 Position" Staple setting, cancel the "Booklet" function, and then select the "2 Position" setting.

2.2.2 Operations where the setting specified first is given priority

If a warning message appears, indicating that settings cannot be combined, those settings cannot be specified together.

The procedure for selecting the "2 Position" Staple setting after setting the "Booklet" function is described below.

- 1 Set the "Booklet" function.

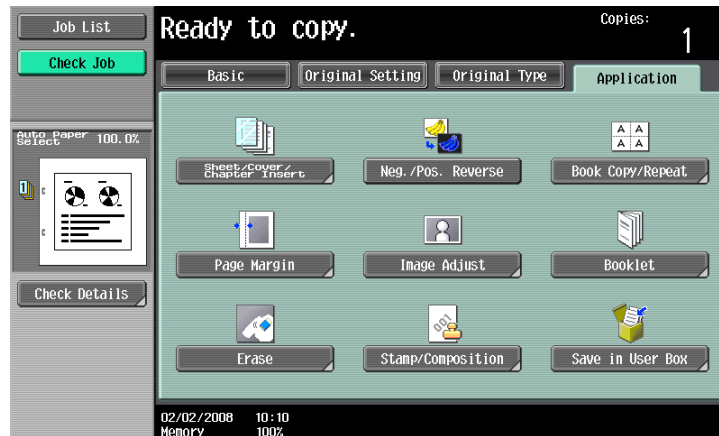

- 2 Select the "2 Position" Staple setting.



The message "Cannot be set with Booklet." appears and the "2 Position" Staple setting cannot be selected.

The "Booklet" function remains selected and the "2 Position" Staple setting is canceled. To select the "2 Position" Staple setting, cancel the "Booklet" function, and then select the "2 Position" Staple setting.

2.3 Feeding the original

The original can be fed in either of the following two ways. Be sure to position the original correctly according to the type of original being copied.

Document Feed Method	Features
Using the ADF	By using the ADF, a multi-page original can be fed automatically, one page at a time. This feed method can also be used to automatically scan double-sided originals.
Using the original glass	Place the original directly on the original glass so that it can be scanned. This method is best with books and other originals that cannot be fed through the ADF.

2.3.1 Loading the original into the ADF

- ✓ Do not load originals that are bound together, for example, with paper clips or staples.
- ✓ For details on the types of originals that can be loaded into the ADF, refer to ["Originals" on page 6-29](#).
- ✓ Do not load more than 100 sheets or so many sheets that the top of the stack is higher than the ▼ mark, otherwise an original misfeed or damage to the original or machine may occur. However, a original that exceeds 100 sheets can be scanned in separate batches. For details, refer to ["Scanning the original in separate batches \("Separate Scan" setting\)" on page 2-8](#).
- ✓ If the original is not loaded correctly, it may not be fed in straight or an original misfeed or damage to the original may occur.
- ✓ If the original is loaded in any orientation other than with the top of the original toward the back of the machine, be sure to select the original orientation. For details on selecting the original orientation, refer to ["Selecting the original orientation \(Original Direction settings\)" on page 2-22](#).

- 1 Place the original in the original feed tray in the order to be scanned with the side to be scanned faces up.
 - Load the original pages so that the top of the original is toward the back or the right side of the machine.

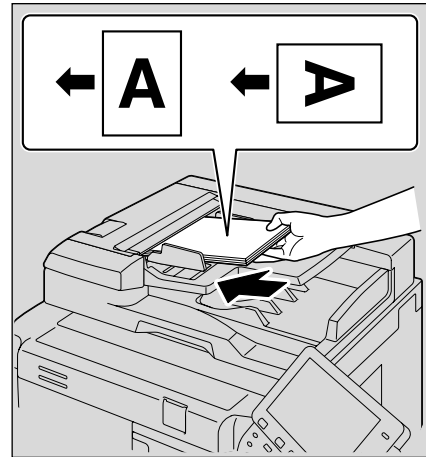

- 2 Adjust the lateral guides to the size of the original.
 - For details on loading originals of mixed sizes, refer to ["Copying originals of mixed sizes \("Mixed Original" setting\)" on page 2-18](#).
 - For details on specifying the original orientation, refer to ["Selecting the original orientation \(Original Direction settings\)" on page 2-22](#).
 - For details on specifying the binding margin position, refer to ["Selecting the position of the binding margin \("Binding Position" settings\)" on page 2-24](#).

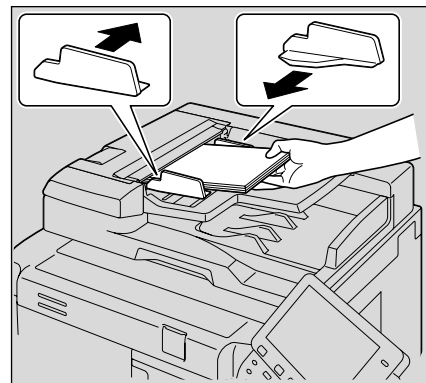

2.3.2 Placing the original on the original glass

- ✓ For details on the types of originals that can be placed on the original glass, refer to **"Originals"** on page 6-29.
- ✓ When placing the original on the original glass, be sure to lift open the ADF at least 20°. If the original is placed on the original glass without the ADF being lifted at least 20°, the correct original size may not be detected.
- ✓ Do not place objects weighing more than 15 lb on the original glass. In addition, do not press down extremely hard on a book spread on the original glass, otherwise the original glass may be damaged.
- ✓ For thick books or large objects, make the copy without closing the ADF. When an original is being scanned with the ADF open, do not look directly at the light that may shine through the original glass. Although the light that shines through the original glass is bright, it is not a laser beam and, therefore, is not as dangerous.

1 Lift open the ADF or the original cover.

2 Place the original face down on the original glass.

- Load the original pages so that the top of the original is toward the back or the left side of the machine.

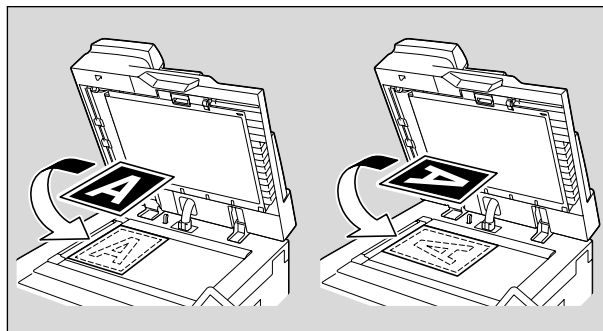

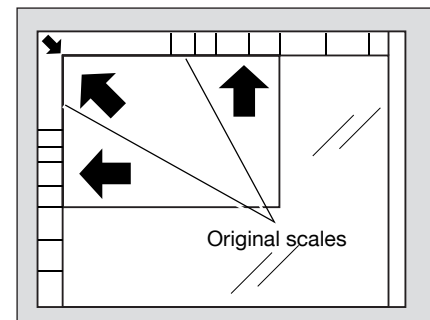

3 Align the original with the  mark in the back-left corner of the original scales.

- For details on selecting the original orientation, refer to **"Selecting the original orientation (Original Direction settings)"** on page 2-22.
- For details on specifying the binding margin position, refer to **"Selecting the position of the binding margin (Binding Position settings)"** on page 2-24.

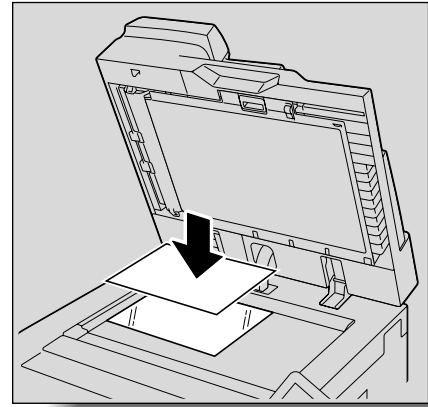

- For transparent or translucent originals, place a blank sheet of paper of the same size as the original over the original.



- For bound originals spread over two facing pages, such as a book or magazine, position the top of the original toward the back of this machine and align the original with the  mark in the back-left corner of the original scales, as shown.

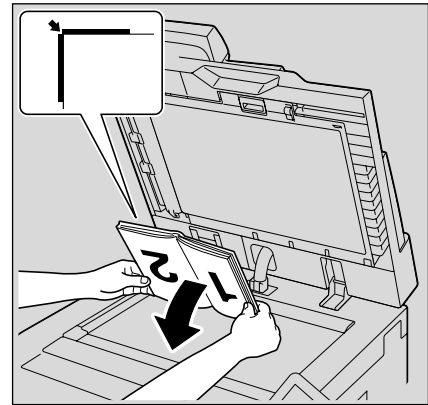

4 Close the ADF.

2.3.3 Scanning the original in separate batches ("Separate Scan" setting)

A large original can be divided and scanned in a number of batches.

A maximum of 100 original pages can be loaded into the ADF at one time. However, by specifying the "Separate Scan" setting, an original that exceeds 100 pages can be scanned and treated as a single copy job. In addition, the scanning location can be switched between the original glass and the ADF during the scanning operation.

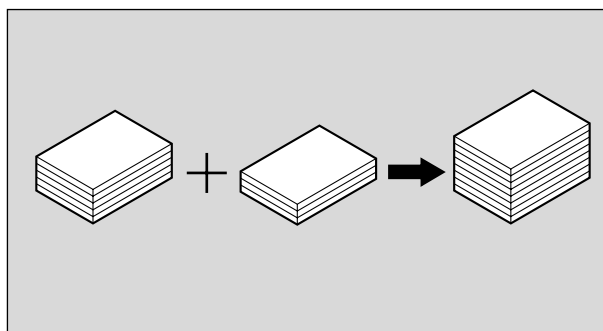

- ✓ The loading capacity of the ADF is 100 sheets of plain paper (21-1/4 lb). Do not allow the original to be loaded over the limit mark (▼), even though the original count is less than 100.
- ✓ The output method used with the "Separate Scan" setting can be set to "Page Print" or "Batch Print". As a default, "Page Print" is selected.
- ✓ For details on the output method used with the "Separate Scan" setting, refer to the description for "Separate Scan Output Method" in **"Copier Settings" on page 11-18**.

1 Position the original to be copied.

- For details on positioning the original, refer to **"Feeding the original" on page 2-6**.

- 2 In the Basic screen, touch [Separate Scan].

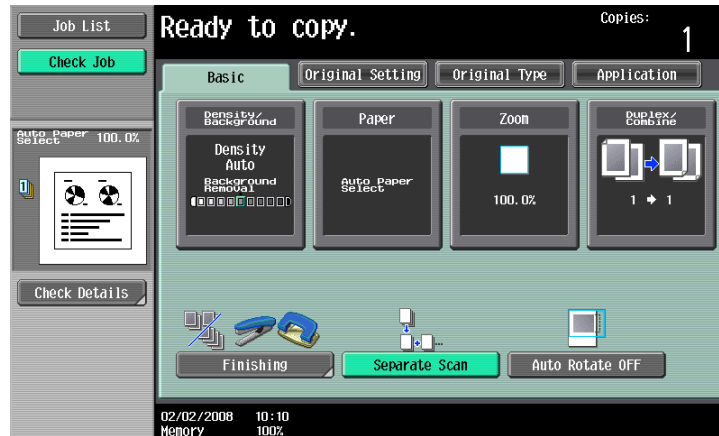

- To cancel the "Separate Scan" setting, touch [Separate Scan] again to deselect it.

- 3 Press the [Start] key.
After the original has been scanned, the following message appears.

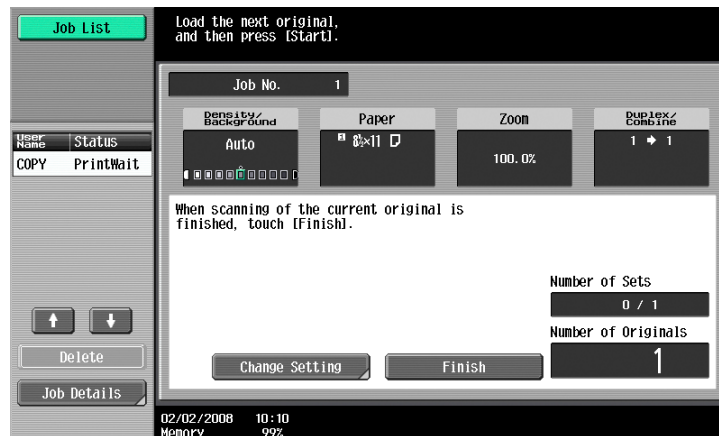

- Load the next batch of the original, and then press the [Start] key.
- If the "Separate Scan Output Method" parameter is set to "Batch Print", touch [Finish] in the following screen, which appears while the original is scanned with the ADF, to continue to step 5.

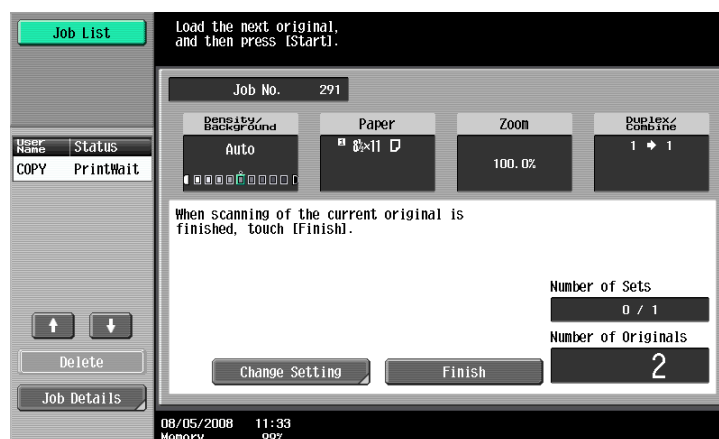

- If the original cannot be loaded into the ADF, place it on the original glass. For details on the types of originals that can be loaded into the ADF, refer to ["Originals" on page 6-29](#).
- To change the scanning settings, touch [Change Setting]. For details on changing the scanning settings, refer to ["Changing scan settings for each original" on page 2-26](#).
- The buttons that appear in the screen for changing the settings differ depending on the specified settings. Settings for the following can be changed.
1-Sided/2-Sided, Density/Background, Original Type, Binding Position, Zoom, Original Size, Frame Erase, Center Erase

- To cancel changes to the settings, touch [Cancel].

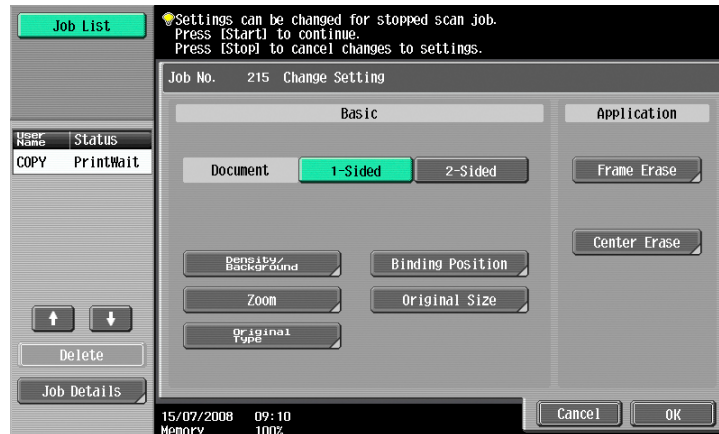

- The amount of memory available can be checked beside "Memory" in the lower-left corner of the screen.
To delete the image data, press the [Stop] key, and then delete the job. For details, refer to ["Temporarily stopping scanning/printing" on page 2-78.](#)

- 4 After all original pages have been scanned, touch [Finish].

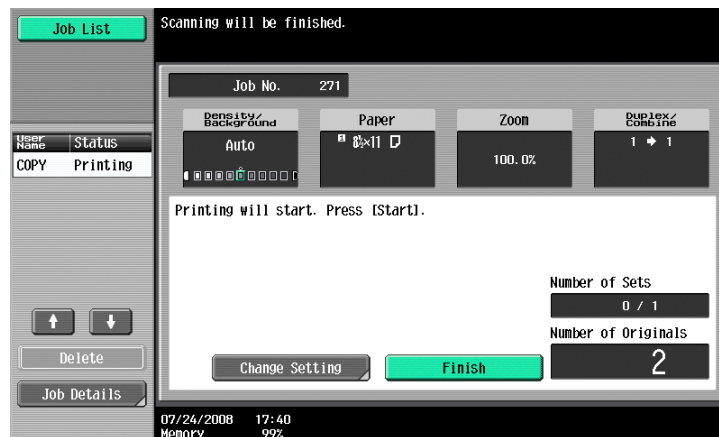

- 5 Press the [Start] key.

- If the "Separate Scan Output Method" parameter is set to "Batch Print", touch [Print] or press the [Start] key.



- If the "Separate Scan Output Method" parameter is set to "Batch Print", the copy settings can be changed. To change the copy settings, touch [Change Setting], and then touch [OK] after changing the settings as desired.

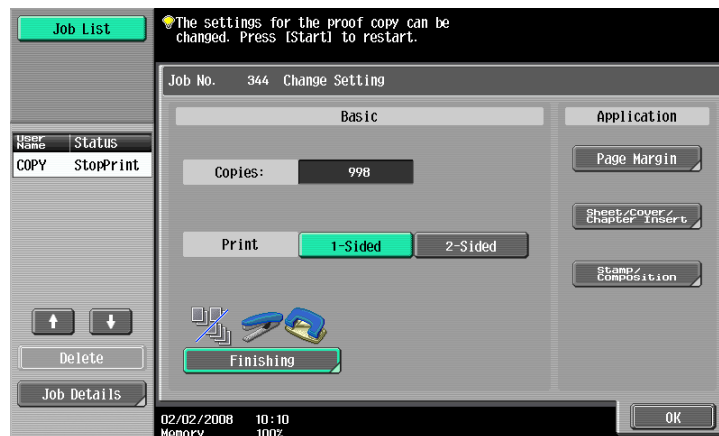

2.3.4 Scanning a multi-page original from the original glass

When making double-sided or combined copies using the original glass, place each page of a multi-page original on the original glass to scan it. The following procedure describes how to place single-sided original pages on the original glass to make double-sided copies.

- ✓ The output method used with the "Separate Scan" setting can be set to "Page Print" or "Batch Print". As a default, "Page Print" is selected.
 - ✓ For details on the output method used with the "Separate Scan" setting, refer to ["Copier Settings" on page 11-18](#).
- 1 Lift open the ADF.
 - 2 Position the first page or the first side of the original face down onto the original glass.
 - For details on positioning the original, refer to ["Placing the original on the original glass" on page 2-7](#).

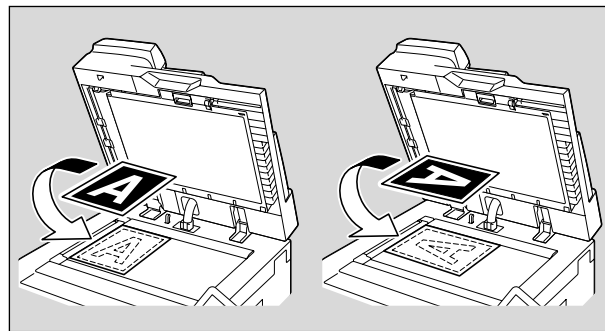

- 3 Close the ADF.

- 4 In the Basic screen, touch [Duplex/Combine].

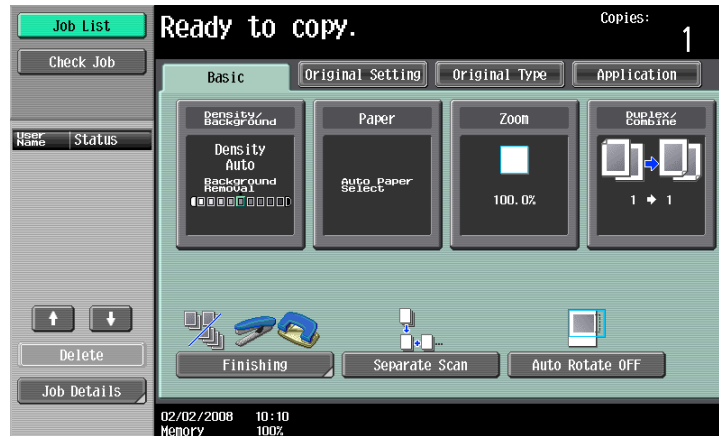

The Duplex/Combine screen appears.

- 5 Touch [1-Sided > 2-Sided].

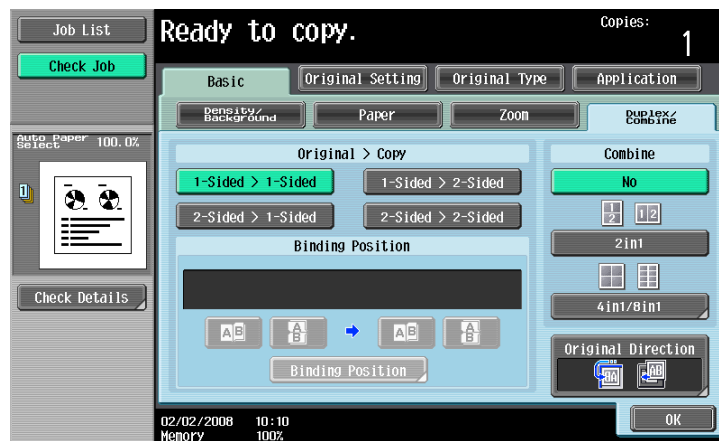

- 6 Touch [Binding Position], select the binding position for the copy, and then touch [OK].
- For details on specifying the binding position, refer to ["Selecting double-sided copies" on page 2-44](#).

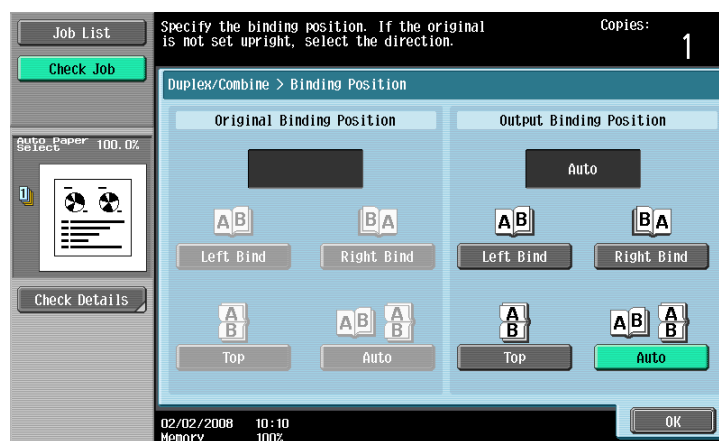

- 7 Touch [Original Direction], select the orientation of the loaded original, and then touch [OK].

- For details on specifying the original orientation, refer to ["Selecting the original orientation \(Original Direction settings\)" on page 2-22.](#)

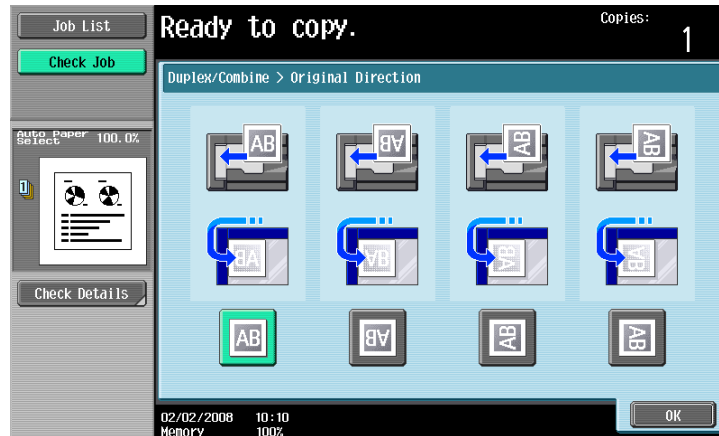

- 8 Touch [OK].
- 9 Press the [Start] key.
Scanning begins.

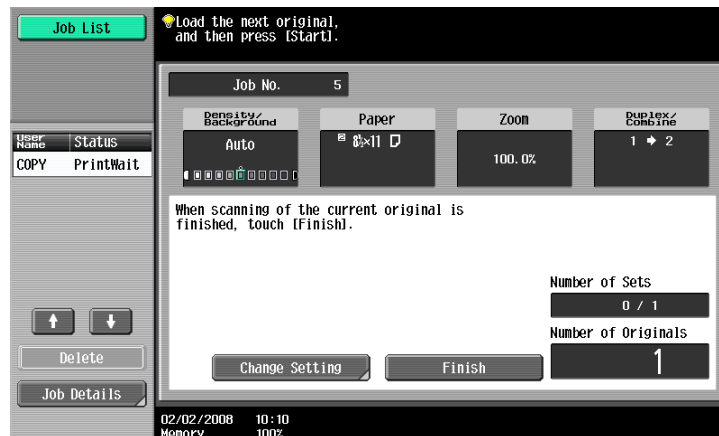

- 10 Position the second page or second side of the original onto the original glass, and then press the [Start] key.
 - To scan the remaining pages in the original, repeat step 10.
 - To change the scanning settings, touch [Change Setting]. For details on changing the scanning settings, refer to ["Changing scan settings for each original" on page 2-26.](#)
 - The buttons that appear in the screen for changing the settings differ depending on the specified settings. Settings for the following can be changed.
1-Sided/2-Sided, Density/Background, Original Type, Binding Position, Zoom, Original Size, Frame Erase, Center Erase

- To cancel changes to the settings, touch [Cancel].

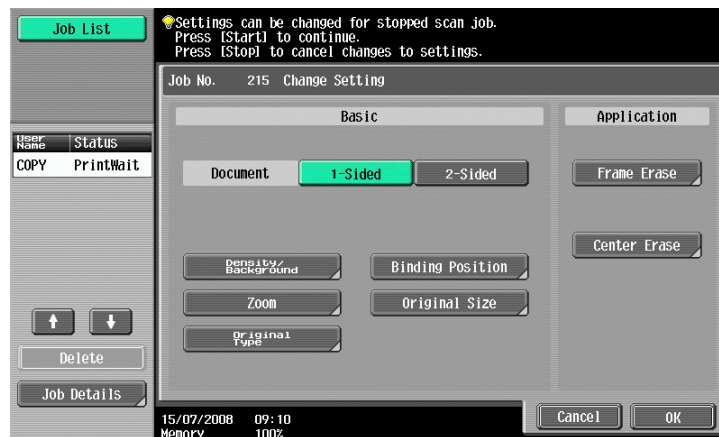

- 11** After all original pages have been scanned, touch [Finish].



- 12** Press the [Start] key.

- If the "Separate Scan Output Method" parameter is set to "Batch Print", touch [Print] or press the [Start] key.



- If the "Separate Scan Output Method" parameter is set to "Batch Print", the copy settings can be changed. To change the copy settings, touch [Change Setting], and then touch [OK] after changing the settings as desired.

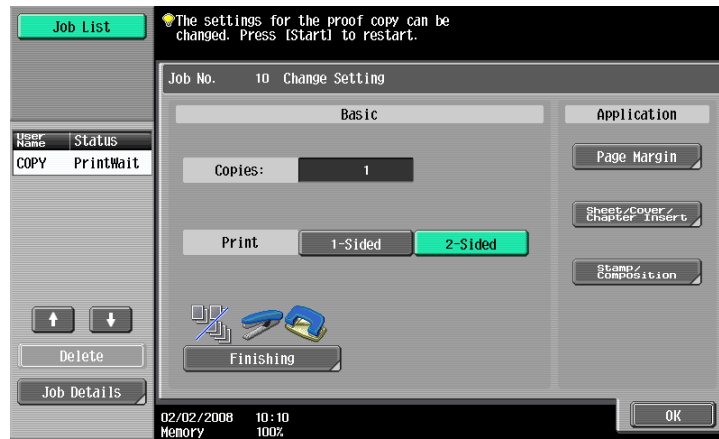

2.4 Specifying original settings

The following describes necessary settings depending on the status and placement of the originals to copy them as desired.

2.4.1 Specifying the original size (Original Size settings)

Copies can be produced after specifying the original scanning size if the original size cannot be detected automatically or if you wish to specify a certain original size.

- 1 Position the original to be copied.
 - For details on positioning the original, refer to ["Feeding the original" on page 2-6](#).
- 2 In the Basic screen, touch [Original Setting].

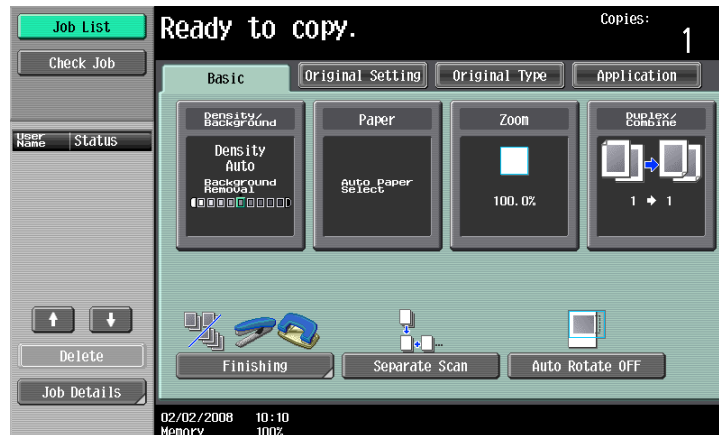

The Original Setting screen appears.

- 3 Touch [Original Size].

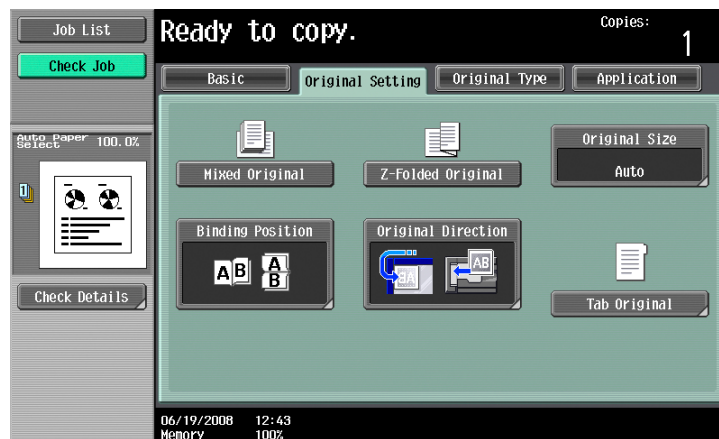

The Original Size screen appears.

- 4 Select the original size, and then touch [OK].
 - Touch [↑] or [↓] to display a different list of standard sizes.

- To specify a standard size, touch the button for the desired original size.

Original Size screen



- To specify a custom size, touch [Custom Size] to display the Custom Size screen. Specify the X and Y sides of the paper, and then touch [OK].
- Touch [X] or [Y], touch [←→] to switch between the integer and the fraction, and then touch [-] and [+] to specify the size of the paper.
- If a decimal value is displayed in the Custom Size screen, use the keypad to type in the setting. For details on switching between decimal and fraction values, refer to ["System Settings" on page 11-15](#).
- To cancel changes to the settings, touch [Cancel].

Custom Size screen

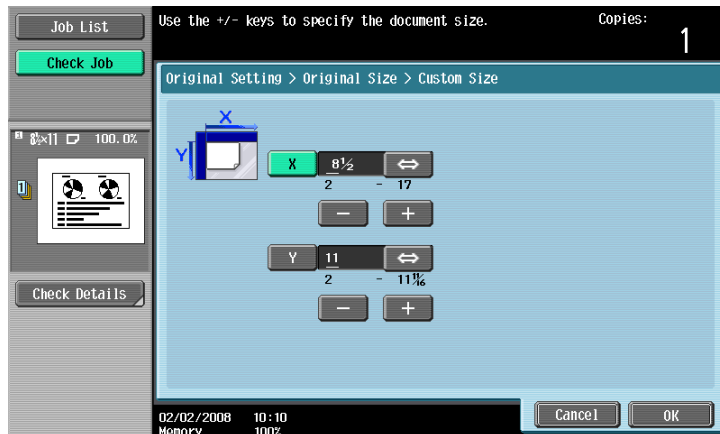

- If a decimal value is displayed in the screen and the specified value is outside the allowable range, the message "Input Error" appears. Type a value within the allowable range. If the value was incorrectly entered, press the [C] (clear) key to erase the value, and then specify the correct value.

2.4.2 Copying originals of mixed sizes ("Mixed Original" setting)

Originals of different sizes can be loaded together into the ADF to be fed and scanned one by one automatically.

- ✓ Do not load more than 100 sheets or so many sheets that the top of the stack is higher than the ▼ mark, otherwise an original misfeed or damage to the original or machine may occur. However, an original that exceeds 100 sheets can be scanned in separate batches. For details, refer to **"Scanning the original in separate batches ("Separate Scan" setting)" on page 2-8.**
- ✓ If the original is not loaded correctly, it may not be fed in straight or an original misfeed or damage to the original may occur.

- 1 Slide the adjustable lateral guides of the ADF to fit the size of the largest page.
 - The possible combinations of original sizes differ depending on the widest original loaded (position of the adjustable lateral guides).
 - For details on the mixed original sizes that can be loaded in the ADF, refer to **"Originals that can be loaded into the ADF" on page 6-29.**

- 2 Align the originals as the references so that the side to be scanned faces up.

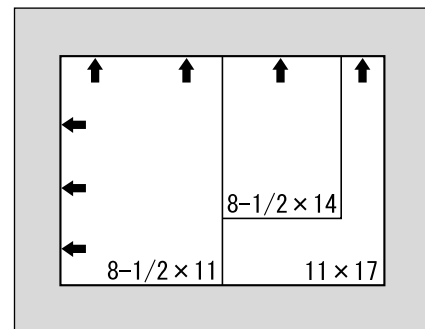

- 3 Place the original in the original feed tray in the order to be scanned with the side to be scanned faces up. Slide the adjustable lateral guides against the edges of the original.
 - Load the original pages into the ADF so that the top of the pages is toward the back or the left side of the machine.

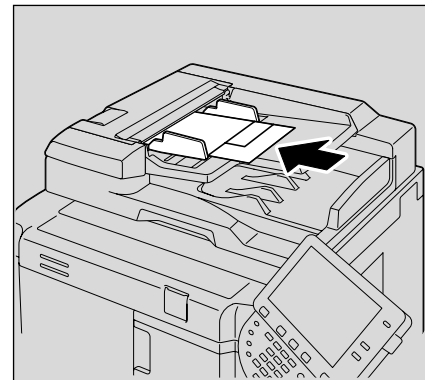

- 4 In the Basic screen, touch [Original Setting].

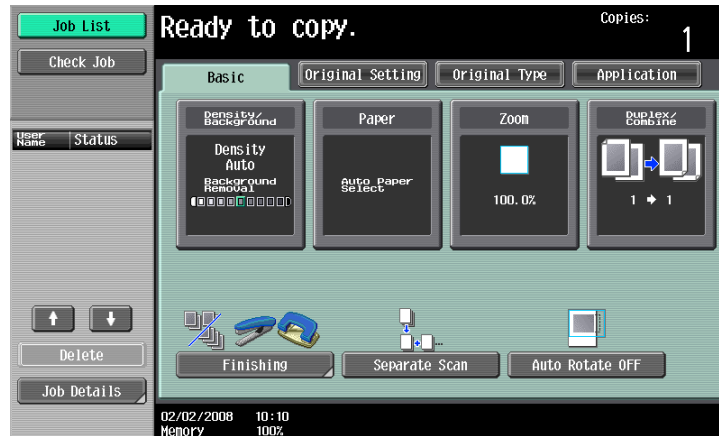

The Original Setting screen appears.

- 5 Touch [Mixed Original].

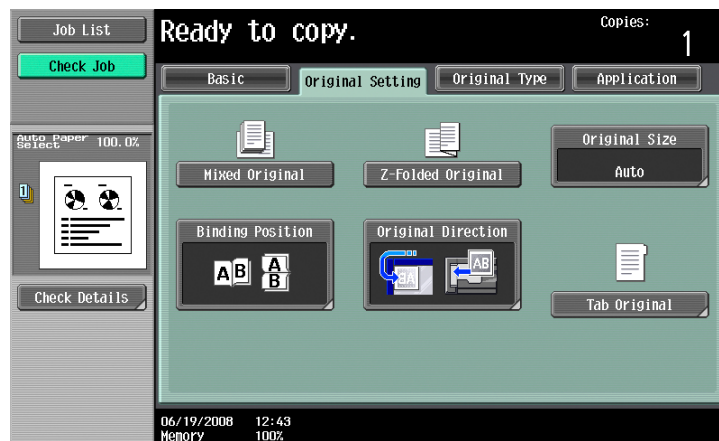

- To cancel the "Mixed Original" setting, touch [Mixed Original] again to deselect it.

2.4.3 Loading folded (Z-folded) originals

If folded originals are loaded into the ADF to be copied, the original size is correctly detected.

- ✓ Load the original into the ADF.
- ✓ The length of the first page of the original is detected, and all pages of the original are scanned at that size.

1 Position the original to be copied.

- Unfold folded originals before loading them into the ADF. If the original is copied without being unfolded, a paper misfeed may occur.
- For details on loading the original, refer to **"Loading the original into the ADF"** on page 2-6.

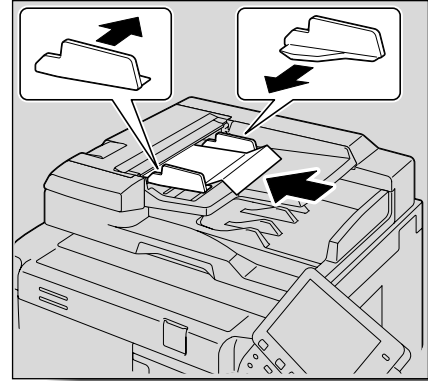

2 In the Basic screen, touch [Original Setting].

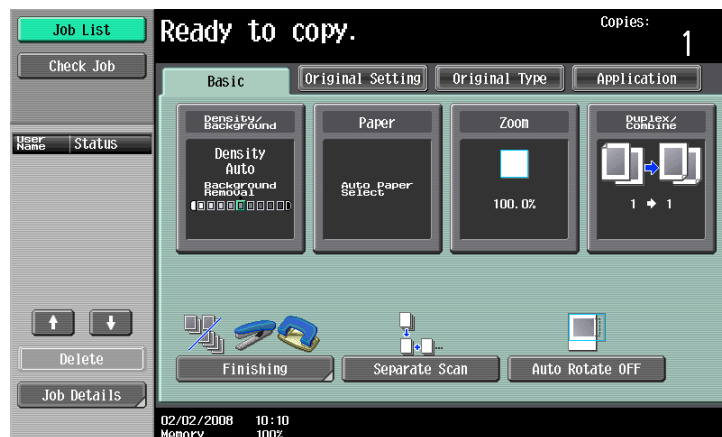

The Original Setting screen appears.

3 Touch [Z-Folded Original].

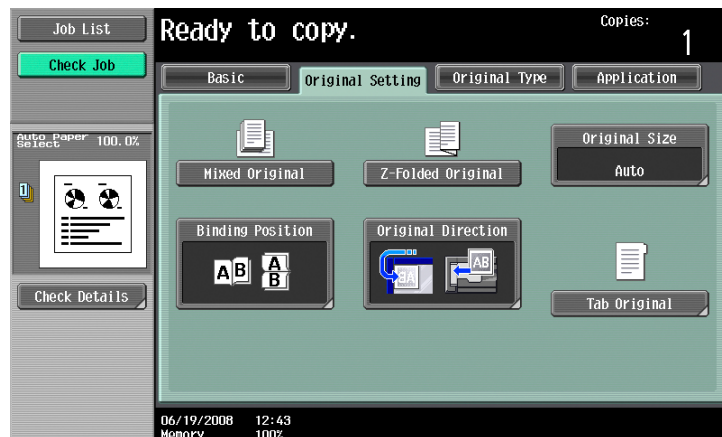

- To cancel the "Z-Folded Original" setting, touch [Z-Folded Original] again to deselect it.

2.4.4 Loading tab paper (Tab Original settings)

Using tab papers enables copying of an original including its index part.

- 1 Position the original to be copied.
 - For details on loading the original, refer to ["Loading the original into the ADF" on page 2-6](#).

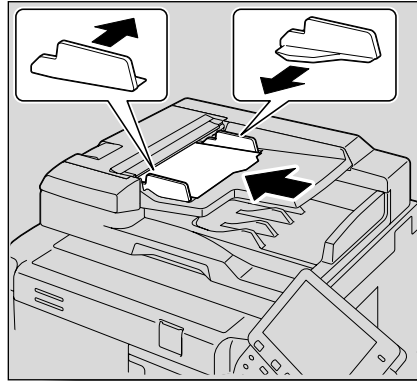

- 2 Load tab papers into the bypass tray.
 - Tab papers can be loaded into the bypass tray. For details, refer to ["Loading paper into the bypass tray" on page 1-53](#).
- 3 In the Basic screen, touch [Original Setting].

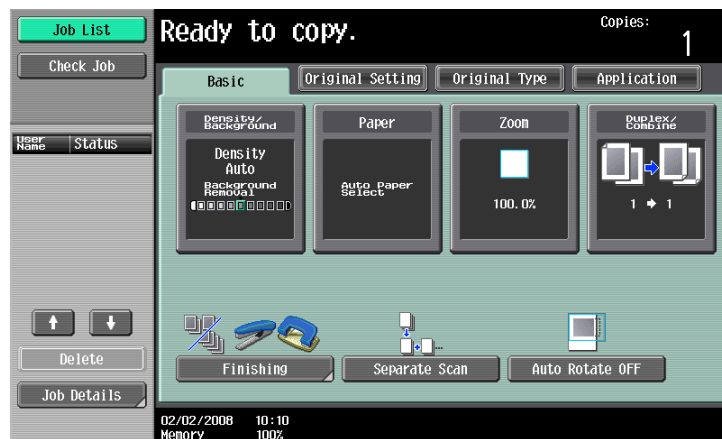

The Original Setting screen appears.

- 4 Touch [Tab Original].

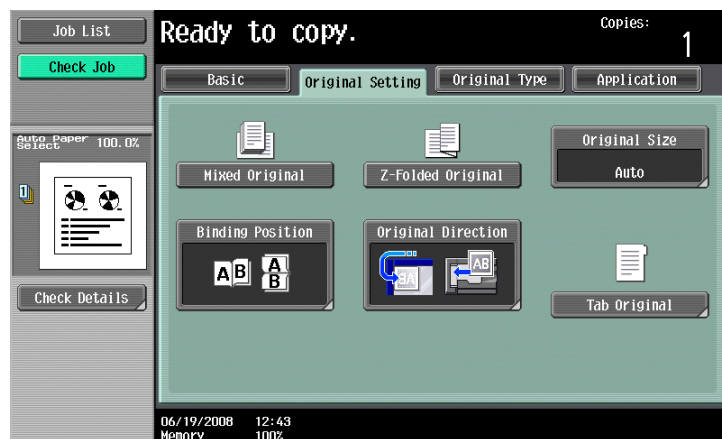

The Tab Original screen appears.

- 5 Select an original size, and then touch [OK].

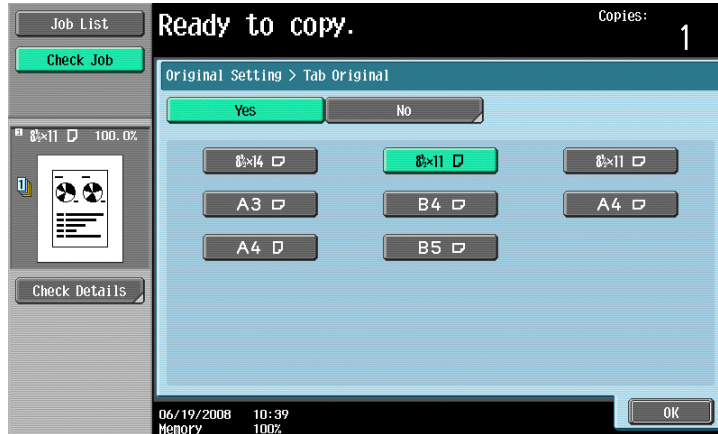

2.4.5 Selecting the original orientation (Original Direction settings)

When copying double-sided originals or making double-sided copies or combined copies, specify the original orientation, otherwise the copies may not be printed in the correct page order or correct front and back page arrangement.







Note

As the factory default, the first setting (with the top of the original at the top (toward the back of the machine)) is selected.

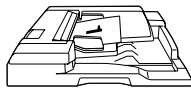
Original loading orientation

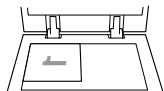
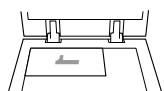
Using the ADF	Using the original glass	Icon	Description
			Select this setting for an original loaded with the top toward the back of this machine.
			Select this setting for an original loaded with the top toward the front of this machine.
			<ul style="list-style-type: none"> Select this setting for an original loaded into the ADF with the top of the original toward the left side of this machine. Select this setting for an original placed on the original glass with the top of the original toward the right side of this machine.

Using the ADF	Using the original glass	Icon	Description
 	 		<ul style="list-style-type: none"> • Select this setting for an original loaded into the ADF with the top of the original toward the right side of this machine. • Select this setting for an original placed on the original glass with the top of the original toward the left side of this machine.

2.4.6 To select an Original Direction setting

- 1 Position the original to be copied.
 - For details on positioning the original, refer to **"Feeding the original"** on page 2-6.
- 2 In the Basic screen, touch [Original Setting].

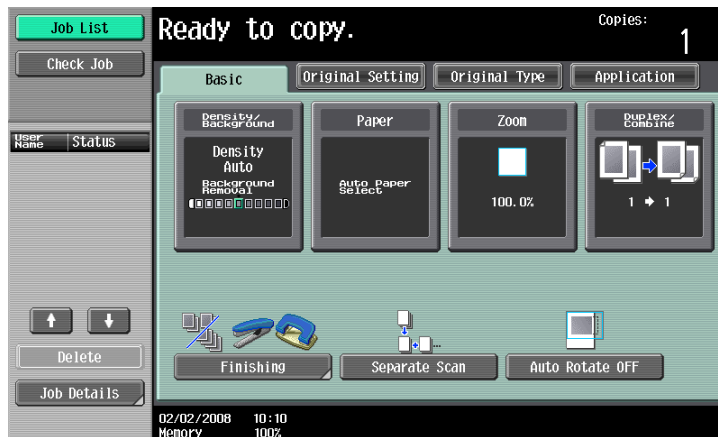

The Original Setting screen appears.

- 3 Touch [Original Direction].

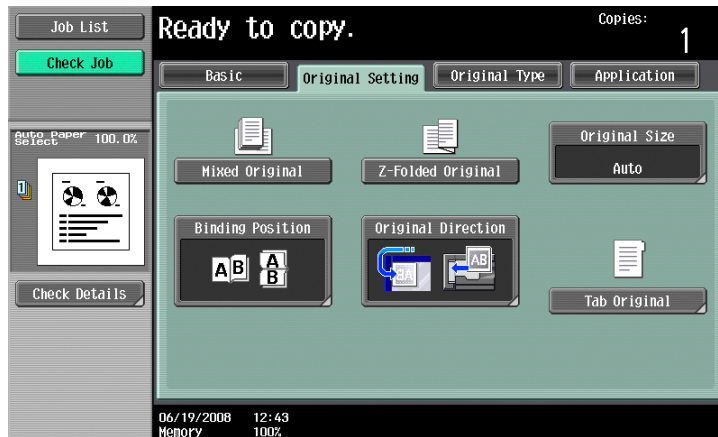

The Original Direction screen appears.

- 4 Touch the button for the orientation of the loaded original, and then touch [OK].

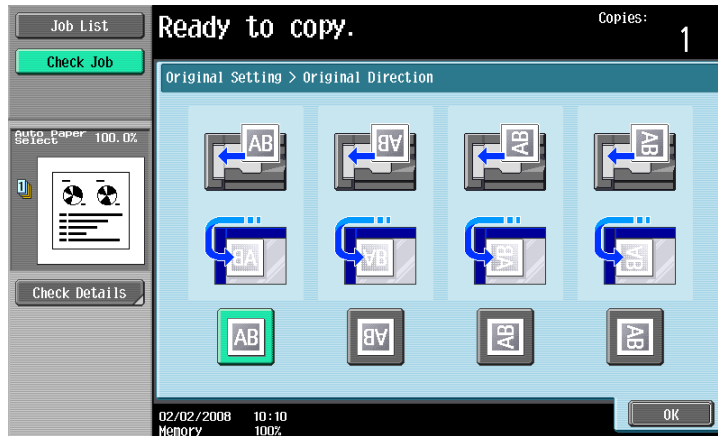

- To cancel the setting and select the default, press the [Reset] key.

2.4.7 Selecting the position of the binding margin ("Binding Position" settings)







If a double-sided original is loaded into the ADF, specify the position of the top of the back side of the original by specifying the binding margin position for the original.



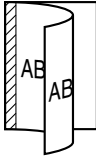

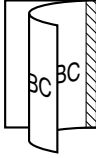
Note

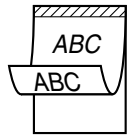
As the factory default, "Auto" is selected as the position of the binding margin.

Original binding margin position

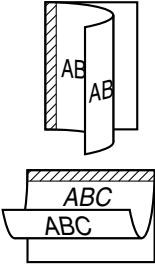
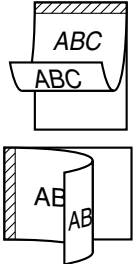
Original binding margin	Icon	Description
	Left 	Select this setting if the original is loaded with the binding margin at the left.
	Right 	Select this setting if the original is loaded with the binding margin at the right.
	Top 	Select this setting if the original that is loaded has a binding margin at the top.

Original binding margin	Icon	Description
<p>When the original length is 11-11/16 inch or less:</p>  <p>When the original length is more than 11-11/16 inch:</p> 	<p>Auto</p> 	<p>Select this setting to automatically select the position of the binding margin.</p> <p>If the original length is 11-11/16 inch or less, a binding position along the long side of the paper is selected.</p> <p>If the original length is more than 11-11/16 inch, a binding position along the short side of the paper is selected.</p> <p>...</p> <p>Note If "Auto" is selected, the binding margin is set at the top or at the left.</p>

2.4.8 To select a Binding Position setting

- 1 Position the original to be copied.
 - For details on positioning the original, refer to "[Feeding the original](#)" on page 2-6.
 - When loading an original with a binding margin, position the top of the original toward the back of the machine.
- 2 In the Basic screen, touch [Original Setting].

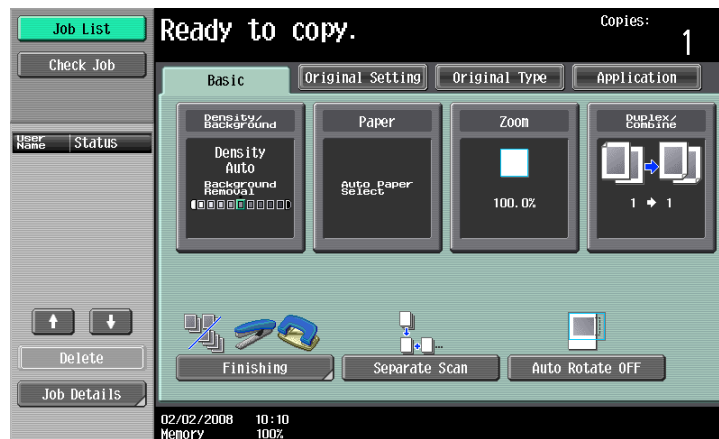

The Original Setting screen appears.

- 3 Touch [Binding Position].

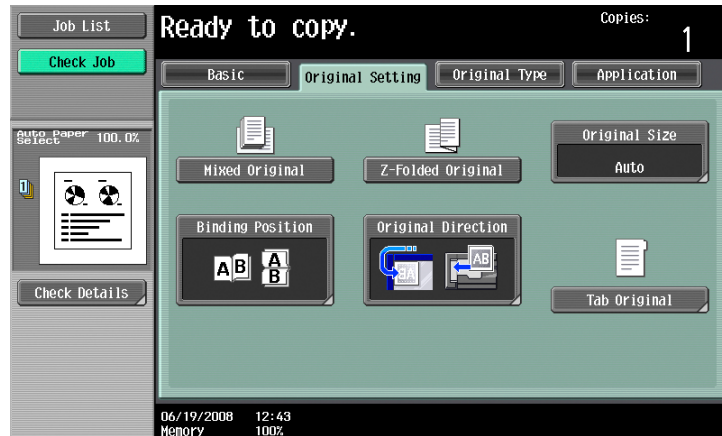

The Binding Position screen appears.

- 4 Touch the button for the desired binding margin position, and then touch [OK].

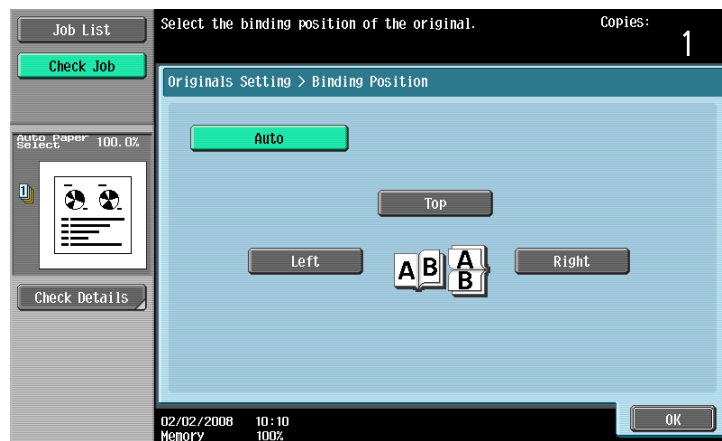

- To cancel the setting and select the default, press the [Reset] key.

2.4.9 Changing scan settings for each original

When scanning an original while using the "Separate Scan" setting or when multi-page originals are scanned from the original glass, the scan settings can be changed for each original. The following procedure describes how to change the settings when the "Separate Scan" setting is used.

- 1 Position the original to be copied.
- 2 In the Basic screen, touch [Separate Scan].

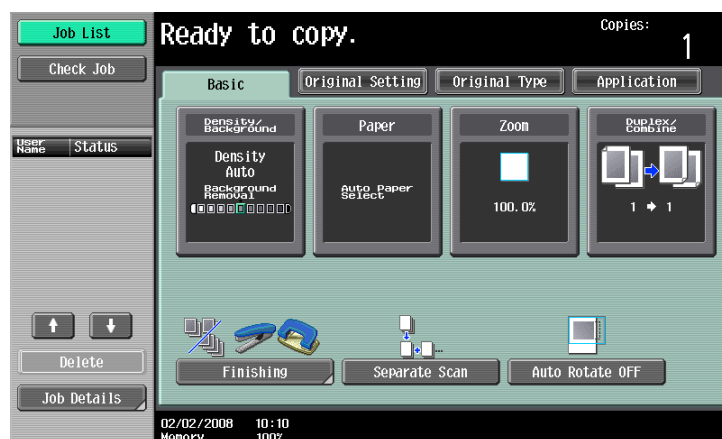

- 3 Press the [Start] key.
Scanning begins.
- 4 Touch [Change Setting].

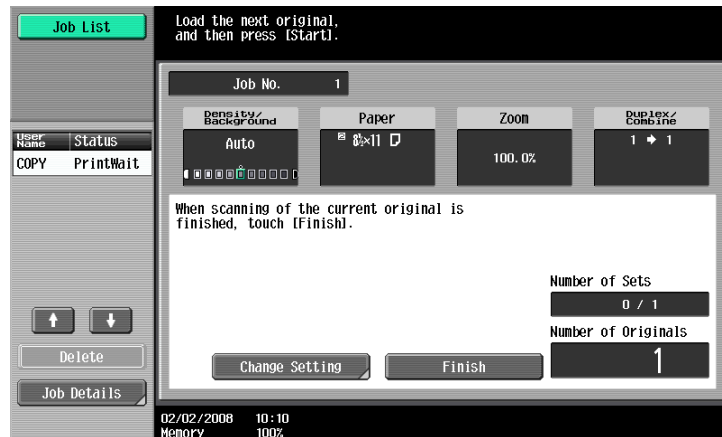

A screen appears, allowing you to change the settings.

- 5 Touch the button of the setting to be changed, select the desired setting, and then touch [OK].
 - The buttons that appear in the screen for changing the settings differ depending on the specified settings. Settings for the following can be changed.
1-Sided/2-Sided, Density/Background, Original Type, Binding Position, Zoom, Original Size, Frame Erase, Center Erase
 - To cancel changes to the settings, touch [Cancel].



Density/Background screen

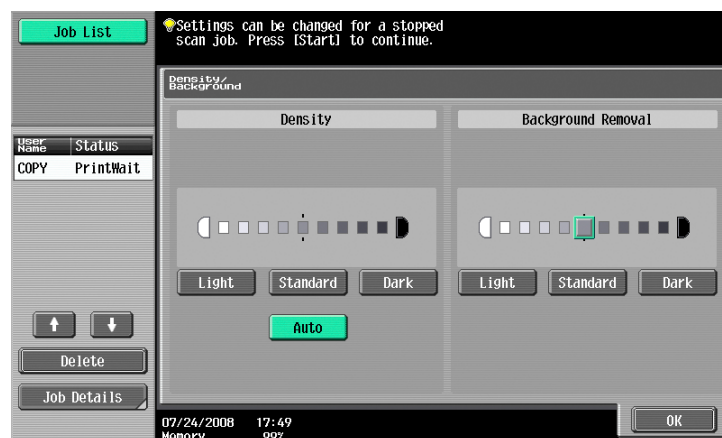

Binding Position screen

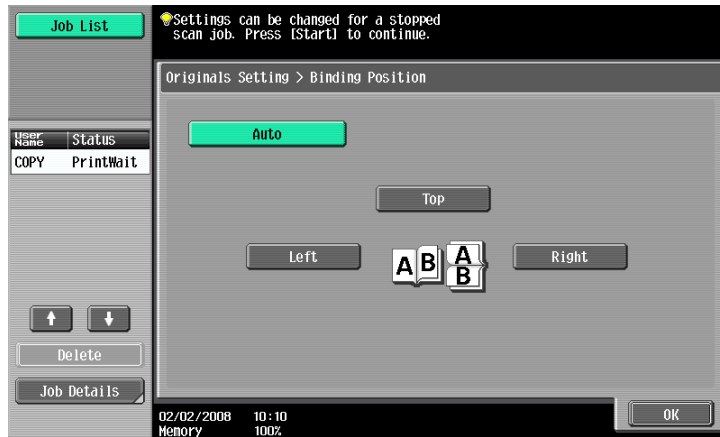

Zoom screen



Frame Erase screen



Original Type screen

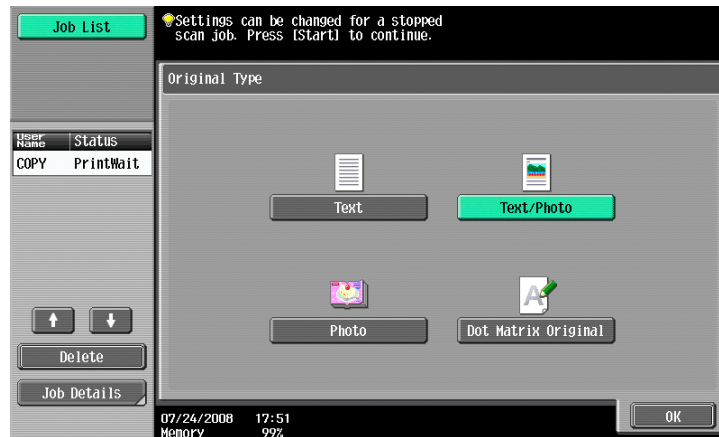

Center Erase screen

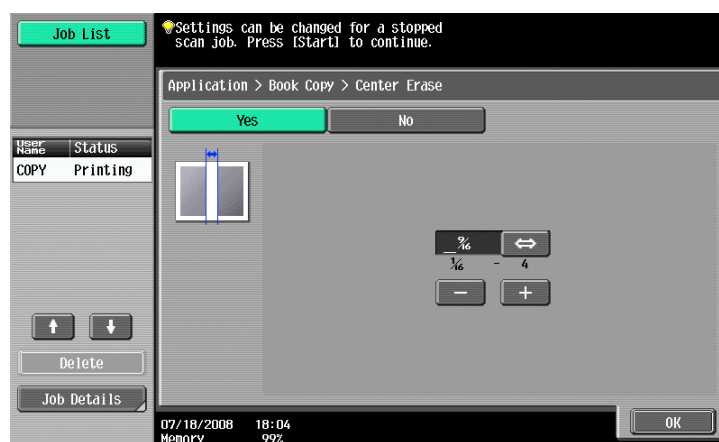

Original Size screen



- For details on specifying the Zoom setting, refer to ["Specifying a Zoom setting" on page 2-32](#). For details on specifying "Frame Erase" and "Center Erase" settings, refer to ["Erasing black marks along borders \("Erase" function\)" on page 7-46](#).
- The Original Size screen appears only when the "Mixed Original" setting is selected.

6 Touch [OK].

2.5 Selecting a Paper Setting

The paper size can be selected automatically according to the original size or it can be specified manually. Specify the paper size according to the corresponding procedure, depending on the desired copy settings.

As the factory default, "Auto" is selected.



Note

If a setting for special paper is selected for a paper tray, that tray is not selected automatically with the "Auto" Paper setting. (However, a paper tray set to "Single Side Only" is given priority to be selected with single-sided printing.) Be sure to specify a paper setting when special paper is loaded into a paper tray. For details, refer to "Specifying a paper type for bypass tray" on page 6-18.

If the "Auto Paper Select" was selected at the "Auto Zoom" setting, the Zoom screen appears. Touch the button for the desired zoom ratio.

The "Auto" Paper setting cannot be combined with the "Auto" Zoom setting.

For details on specifying the priority of paper trays, refer to "Specifying user settings" on page 11-15.

2.5.1 Automatically selecting the paper size ("Auto" Paper setting)

The size of the loaded original is detected, and copies are produced using paper of the same size.

If the "Full Size" Zoom setting was specified, paper of the same size as the original is selected.

If the zoom ratio was increased or decreased, a paper size that corresponds to the specified zoom ratio is automatically selected.

- 1 In the Basic screen, touch [Paper].

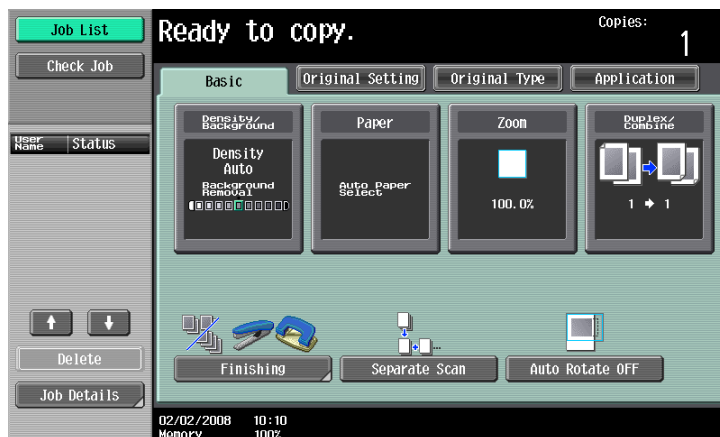

The Paper screen appears.

- 2 Touch [Auto].



- 3 Touch [OK].
The Basic screen appears again.

2.5.2 Manually selecting the desired paper size

- ✓ By also selecting the "Auto" Zoom setting, the most appropriate zoom ratio is selected based on the size of the loaded original and the specified paper size. For details on the "Auto" Zoom setting, refer to ["Automatically selecting the zoom ratio \("Auto" Zoom Setting\)" on page 2-32](#).
- ✓ Load the appropriate papers into the paper tray in advance.

- 1 In the Basic screen, touch [Paper].

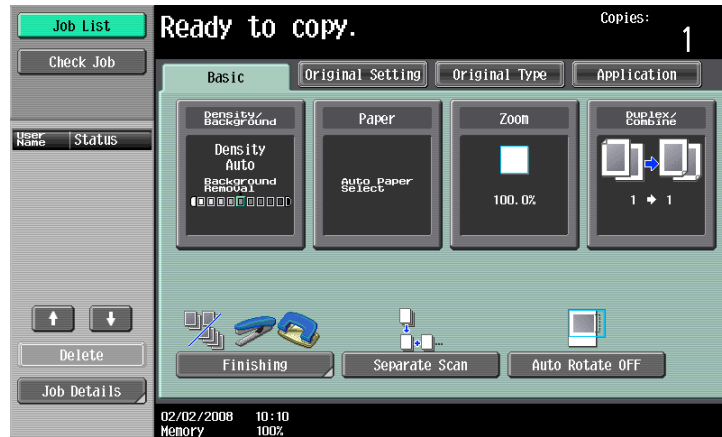

The Paper screen appears.

- 2 Select the paper tray loaded with the desired paper.

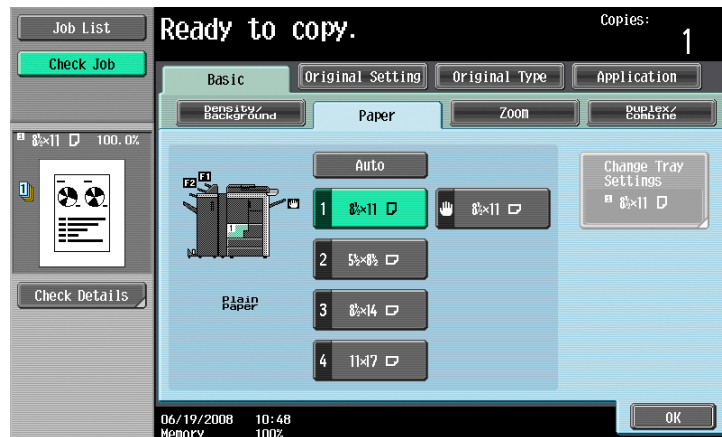

- 3 Touch [OK].
The Basic screen appears again.

2.6 Specifying a Zoom setting

The zoom ratio can be set in order to make a copy on paper with a size different than the original or to enlarge or reduce the size of the copy image. As the factory default, "Full Size" is selected.

The following procedures describe how to specify the Zoom setting.



Note

The "Auto" Zoom setting cannot be combined with the "Auto" Paper setting.

2.6.1 Automatically selecting the zoom ratio ("Auto" Zoom Setting)

The most appropriate zoom ratio is automatically selected based on the size of the loaded original and the specified paper size.

- ✓ If the "Auto" Zoom setting is selected and an enlargement is to be copied on paper larger than the original, load the original with the same orientation as the paper.
- ✓ If the "Auto Zoom" was selected at the "Auto Paper Select" setting, the Paper screen appears.

- 1 In the Basic screen, touch [Zoom].

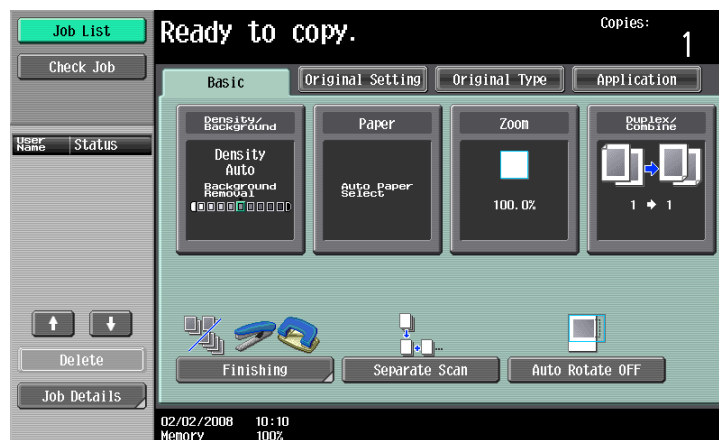

The Zoom screen appears.

- 2 Touch [Auto].

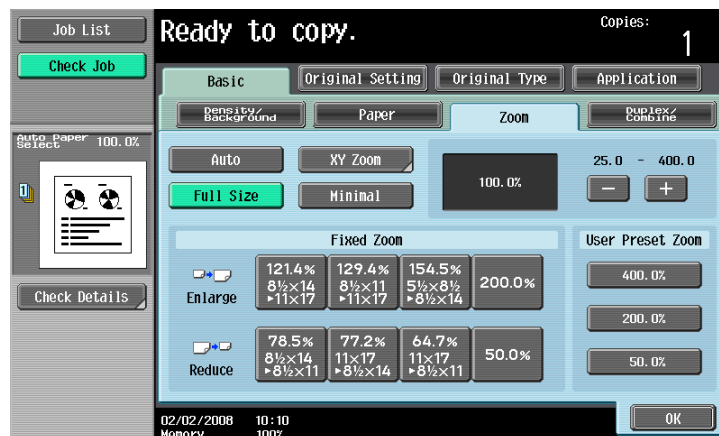

- 3 Touch [OK].

The Basic screen appears again.

2.6.2 Specifying the zoom ratio of the original ("Full Size" setting)

A copy that is the same size as the original (100%) is produced.

- ✓ Touch [+] to enlarge the zoom ratio, and touch [-] to reduce the zoom ratio in 0.1% increments.

- 1 In the Basic screen, touch [Zoom].

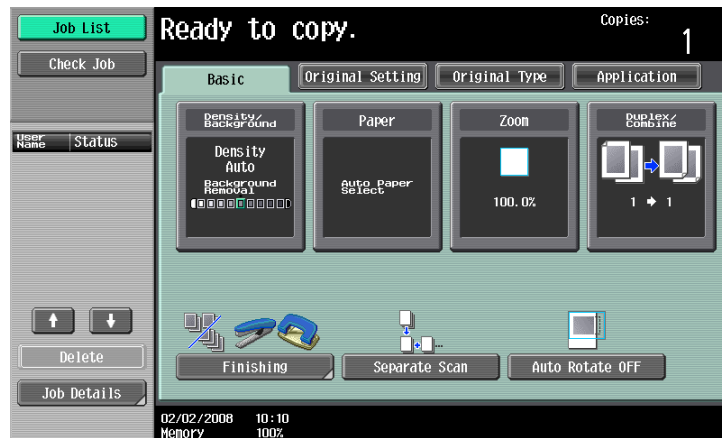

The Zoom screen appears.

- 2 Touch [Full Size].

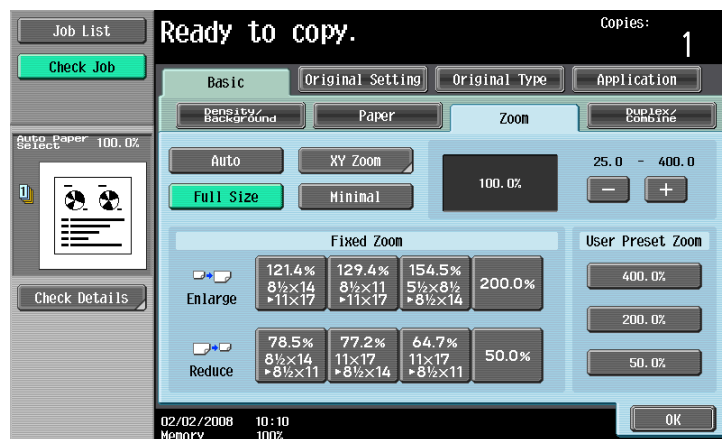

- 3 Touch [OK].

The Basic screen appears again.

2.6.3 Typing in the zoom ratio (XY Zoom setting)

By using the keypad, a zoom ratio between 25.0% and 400.0% can be typed in directly without changing the height-to-width ratio.

- ✓ If a value outside the allowable range is specified, the message "Input error" appears. Type a value within the allowable range. If the value was incorrectly entered, press the [C] (clear) key to erase the value, and then specify the correct value.
- ✓ The entered zoom ratio can be stored. For details on storing zoom ratios, refer to ["Storing the desired zoom ratio" on page 2-40](#).

- 1 In the Basic screen, touch [Zoom].

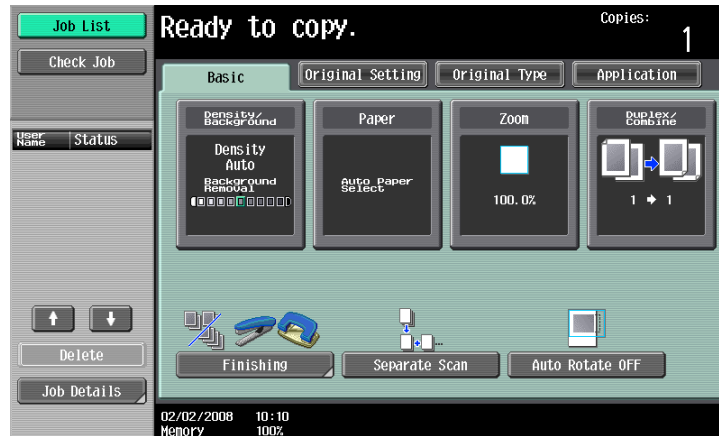

The Zoom screen appears.

- 2 Touch [XY Zoom].

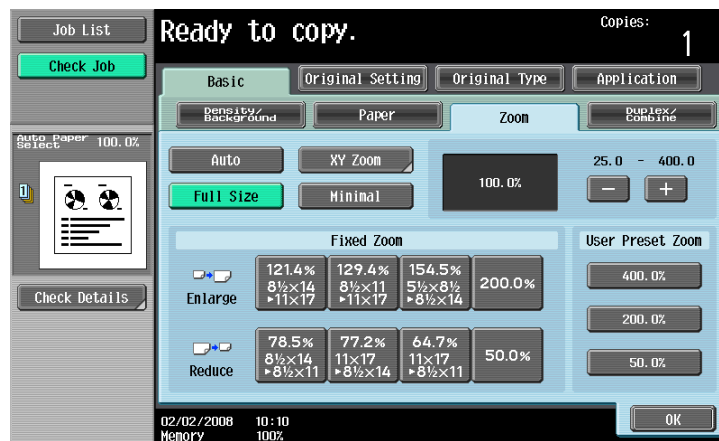

- 3 Using the keypad, type in the desired zoom ratio (between 25.0% and 400.0%).

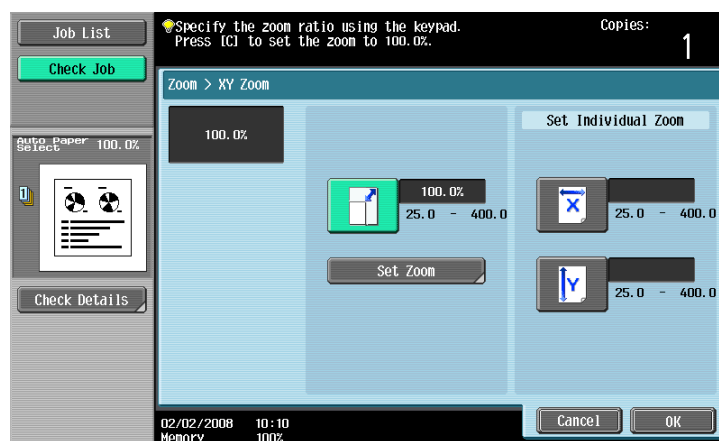

- 4 Touch [OK], and then touch [OK] in the next screen that appears. The Basic screen appears again.

2.6.4 Slightly reducing the copy ("Minimal" setting)

An original image can be printed slightly smaller (93.0%) than the original size and centered in the copy.

- ✓ The zoom ratio of the "Minimal" setting can be changed (between 90.0% and 99.9%). For details on changing the zoom ratio for the "Minimal" setting or programming custom zoom ratios, refer to ["Storing the desired zoom ratio" on page 2-40](#).

- 1 In the Basic screen, touch [Zoom].

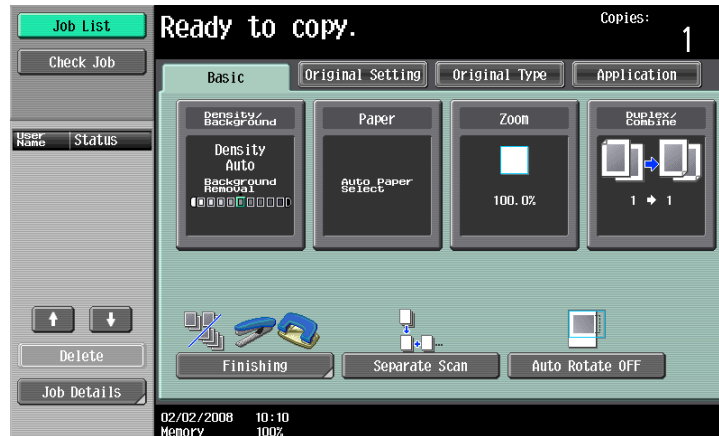

The Zoom screen appears.

- 2 Touch [Minimal].

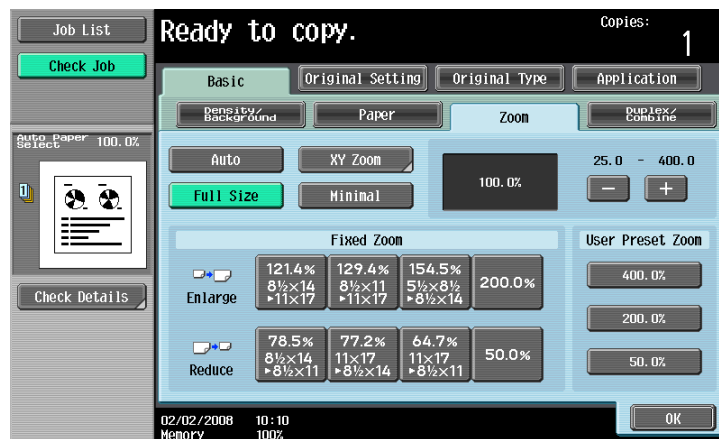

- 3 Touch [OK].

The Basic screen appears again.

2.6.5 Selecting a preset zoom ratio (Enlarge and Reduce settings)

The most suitable zoom ratios for copying from common standard original sizes to standard paper sizes are preset.

- 1 In the Basic screen, touch [Zoom].

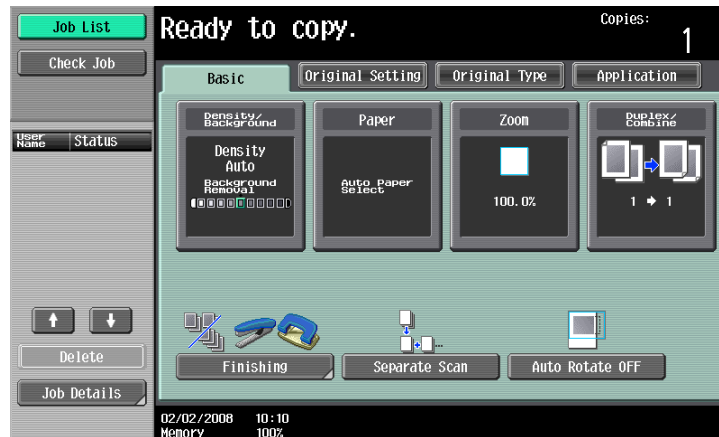

The Zoom screen appears.

- 2 Touch the button for the appropriate zoom ratio beside "Enlarge" and "Reduce", depending on the original and paper sizes.

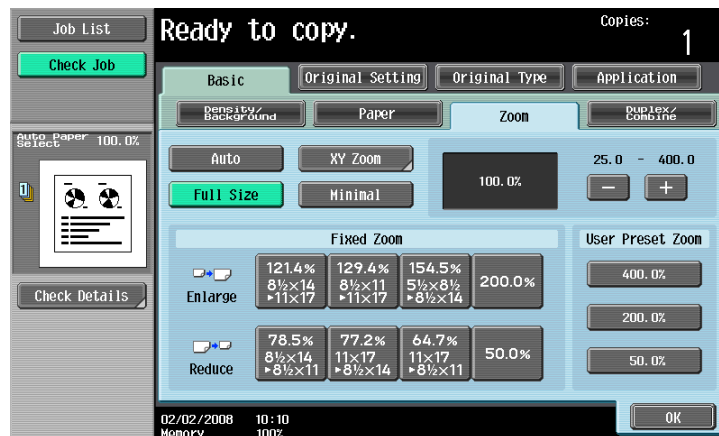

- 3 Touch [OK].
The Basic screen appears again.

2.6.6 Typing in separate X and Y zoom ratios (Individual Zoom settings)

By using the keypad, separate zoom ratios can be typed in directly for the horizontal direction (between 25.0% and 400.0%) and for the vertical direction (between 25.0% and 400.0%).

By combining different horizontal and vertical zoom ratios, the copy image can be adjusted as shown below.

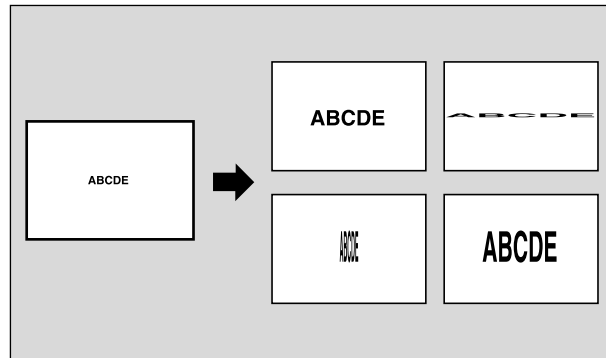

- ✓ If a value outside the allowable range is specified, the message "Input error" appears. Type a value within the allowable range.
If the value was incorrectly entered, press the [C] (clear) key to erase the value, and then specify the correct value.

- 1 In the Basic screen, touch [Zoom].

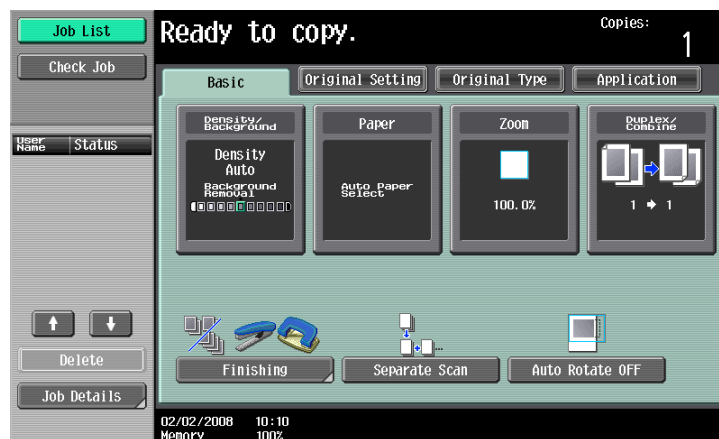

The Zoom screen appears.

- 2 Touch [XY Zoom].

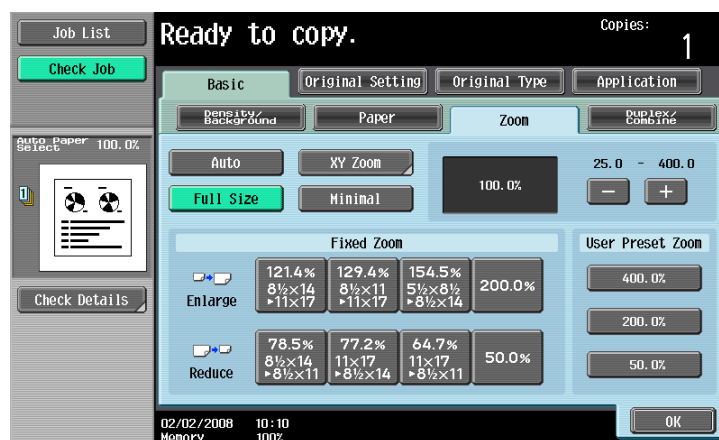

- 3 Touch [X] under "Set Individual Zoom", and then use the keypad to type in the desired zoom ratio (between 25.0% and 400.0%) for the X direction.

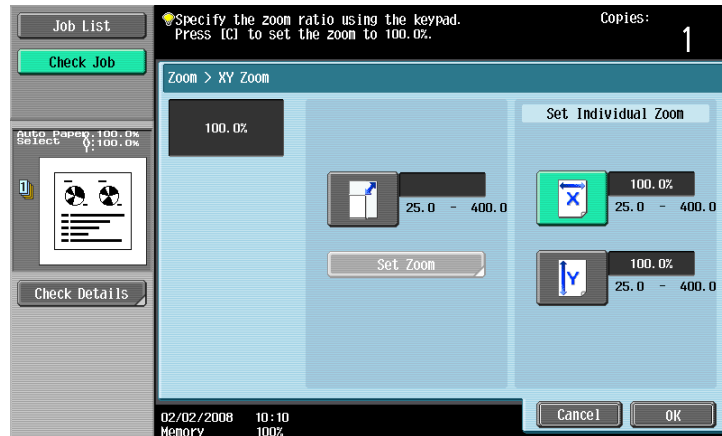

- 4 Touch [Y] under "Set Individual Zoom", and then use the keypad to type in the desired zoom ratio (between 25.0% and 400.0%) for the Y direction.

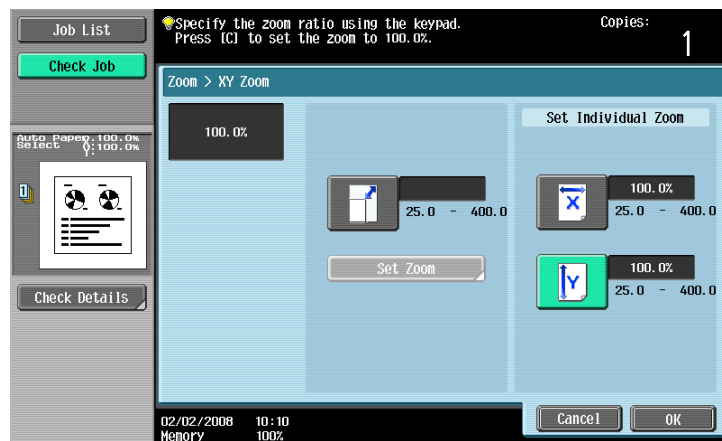

– To cancel changes to the settings, touch [Cancel].

- 5 Touch [OK], and then touch [OK] in the next screen that appears. The Basic screen appears again.

2.6.7 Selecting a stored zoom ratio

Copy zoom ratios that have been stored can be recalled to be used when desired.

In addition, stored copy zoom ratios can be changed.

- ✓ As the factory default, "Full Size" is selected.
- ✓ Touch [+] to enlarge the zoom ratio, and touch [-] to reduce the zoom ratio in 0.1% increments.
- ✓ Stored zoom ratios can be changed to desired zoom ratios. For details on storing zoom ratios, refer to ["Storing the desired zoom ratio" on page 2-40](#).

- 1 In the Basic screen, touch [Zoom].

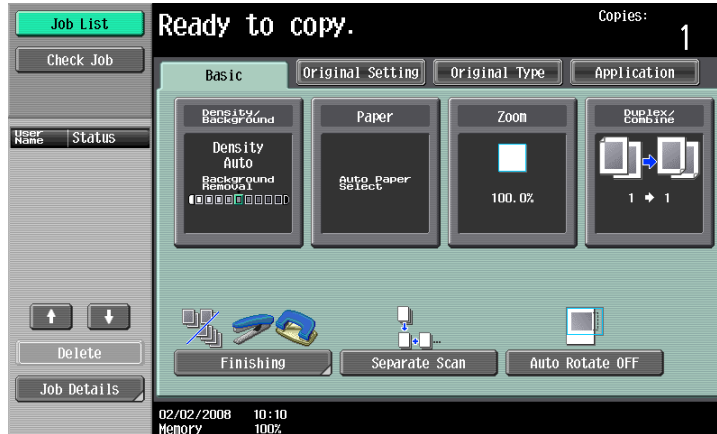

The Zoom screen appears.

- 2 Touch the button for the desired zoom ratio under "Set Zoom Ratio".

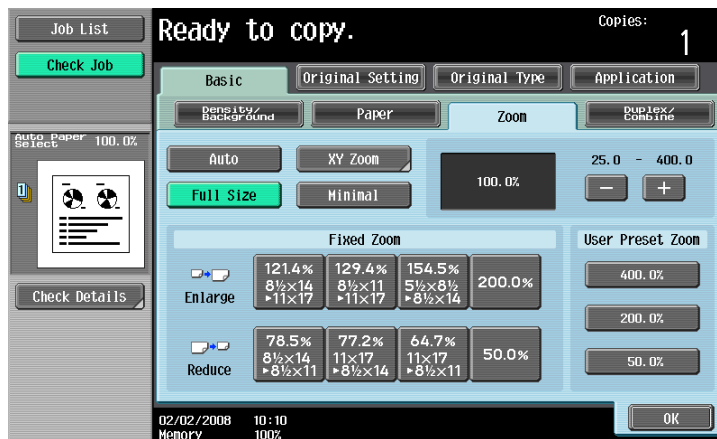

- 3 Touch [OK].
The Basic screen appears again.

2.6.8 Storing the desired zoom ratio

Three frequently used zoom ratios and the zoom ratio for the "Minimal" setting can be stored.

- ✓ If a value outside the allowable range is specified, the message "Input error" appears. Type a value within the allowable range.
If the value was incorrectly entered, press the [C] (clear) key to erase the value, and then specify the correct value.
- ✓ To store a "Minimal" zoom ratio, type in the desired zoom ratio between 90.0% and 99.9%.
- ✓ The default zoom ratios (400.0%, 200.0% and 50.0%) are stored. When a new zoom ratio is stored, it overwrites the zoom ratio stored with the selected button.
If a button stored with a zoom ratio is not touched before [OK] is touched, no setting is changed.

- 1 In the Basic screen, touch [Zoom].

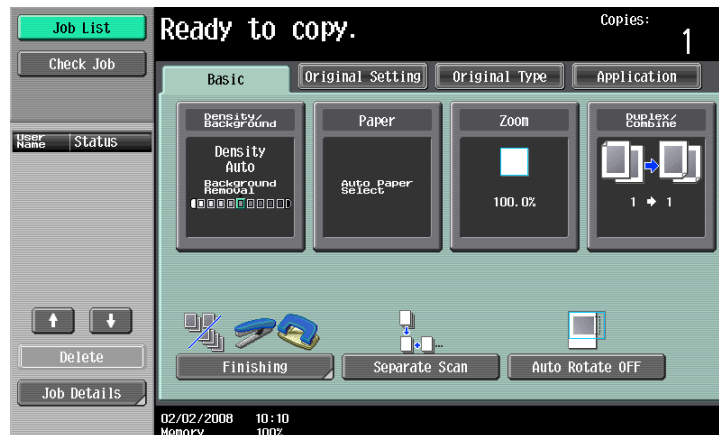

The Zoom screen appears.

- 2 Touch [XY Zoom].

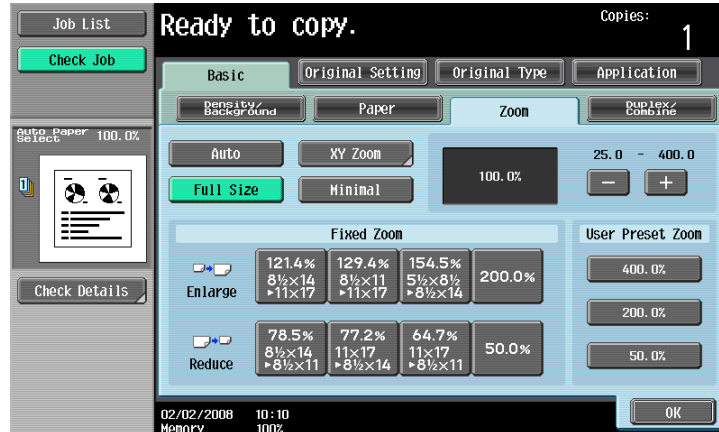

- 3 Using the keypad, type in the desired zoom ratio (between 25.0% and 400.0%).

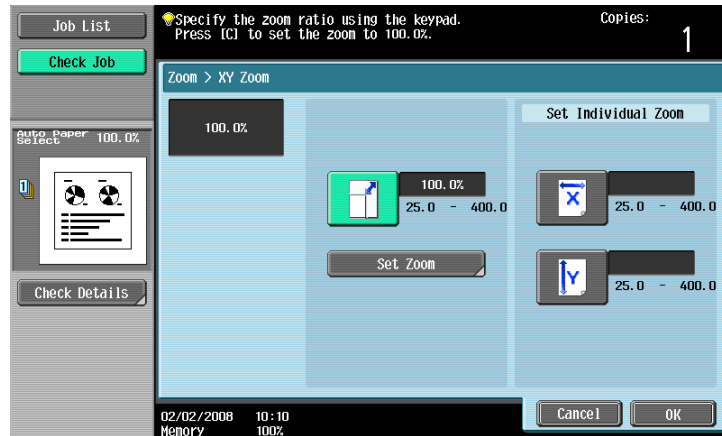

- To cancel changes to the settings, touch [Cancel].

- 4 Touch [Set Zoom].

- 5 Touch the button or [Minimal] where the new zoom ratio is to be stored.

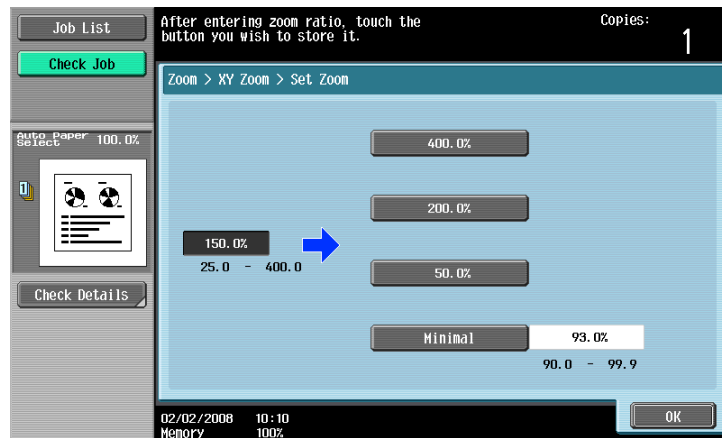



- To cancel the setting and select the default, press the [Reset] key. The specified zoom ratio is stored.

- 6 Touch [OK], and then touch [OK] in the next two screens that appear. The Basic screen appears again.

2.7 Selecting an Original > Copy setting

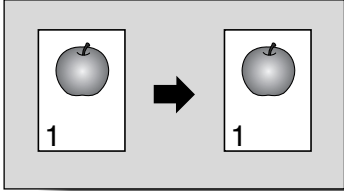
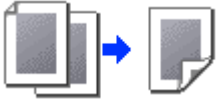
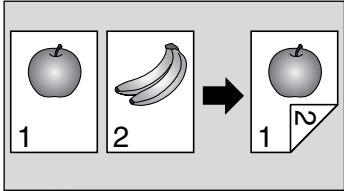
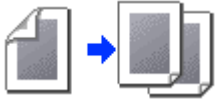
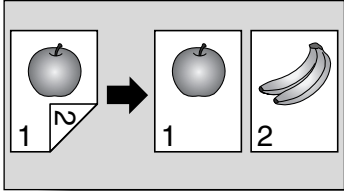
The following four Original > Copy setting combinations are possible.

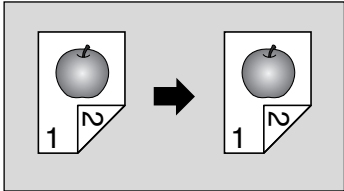
Original > Copy setting	Description
<p>1-Sided > 1-Sided</p> 	<p>Select this setting to produce single-sided copies from single-sided originals.</p> 
<p>1-Sided > 2-Sided</p> 	<p>Select this setting to produce one double-sided copy from two single-sided originals.</p> 
<p>2-Sided > 1-Sided</p> 	<p>Select this setting to produce two single-sided copies from one double-sided original.</p> 
<p>2-Sided > 2-Sided</p> 	<p>Select this setting to produce double-sided copies from double-sided originals.</p> 

The following procedures describe how to select Original and Copy setting.

2.7.1 Selecting single-sided copies

- ✓ As the factory default, "1-Sided > 1-Sided" is selected.
- ✓ For details on using the original glass to scan multi-page originals, refer to ["Scanning a multi-page original from the original glass" on page 2-11](#).

- 1 In the Basic screen, touch [Duplex/Combine].

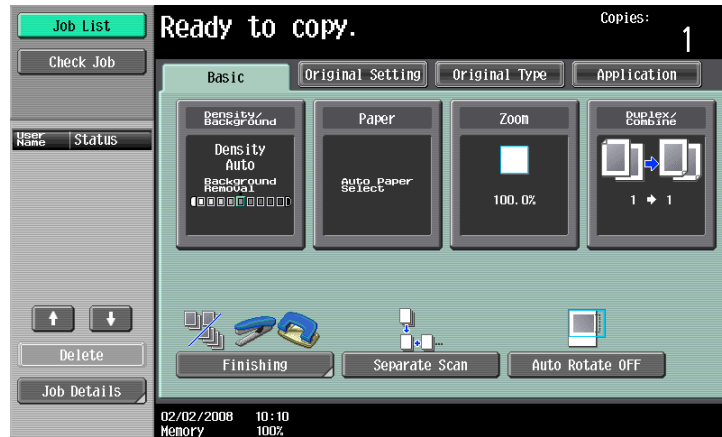

The Duplex/Combine screen appears.

- 2 Touch [1-Sided > 1-Sided] or [2-Sided > 1-Sided].

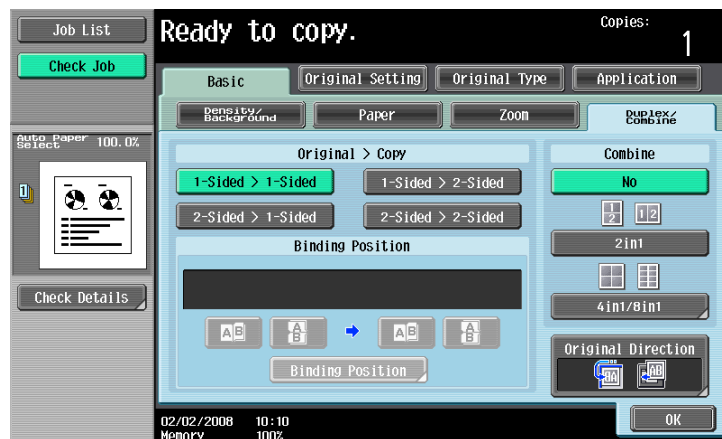

- If "2-Sided > 1-Sided" is selected, specify the position of the binding margin and the orientation of the loaded original, otherwise the copies will not be printed as desired.
- If the binding position for the original is set to "Auto", the position of the binding margin is automatically selected. A binding margin along the long side of the paper is selected if the original length is 11-11/16 inch or less. If the original length is more than 11-11/16 inch, a binding margin along the short side of the paper is selected.
- If "Auto" is selected under "Original Bind Direction", the binding margin is set at the top or at the left.

- For a double-sided original, touch [Binding Position], select the binding position of the original, and then touch [OK].

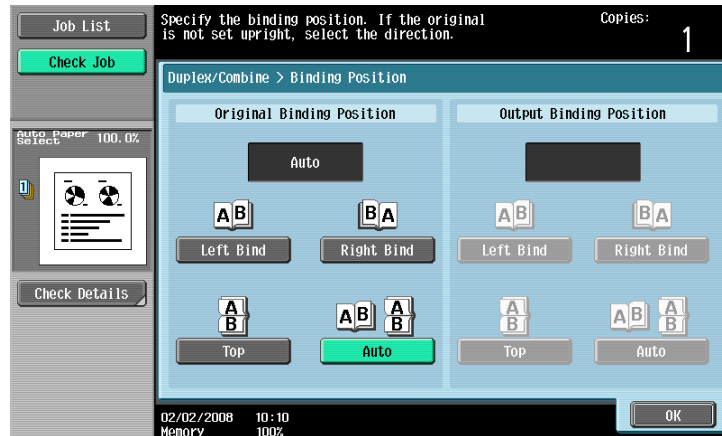

- 3 Touch [Original Direction], select the orientation of the loaded original, and then touch [OK].
 - For details on specifying the original orientation, refer to ["Selecting the original orientation \(Original Direction settings\)" on page 2-22.](#)

- 4 Touch [OK].
The Basic screen appears again.

2.7.2 Selecting double-sided copies

- ✓ As the factory default, "1-Sided > 1-Sided" is selected.
- ✓ For details on using the original glass to scan multi-page originals, refer to ["Scanning a multi-page original from the original glass" on page 2-11.](#)

- 1 In the Basic screen, touch [Duplex/Combine].

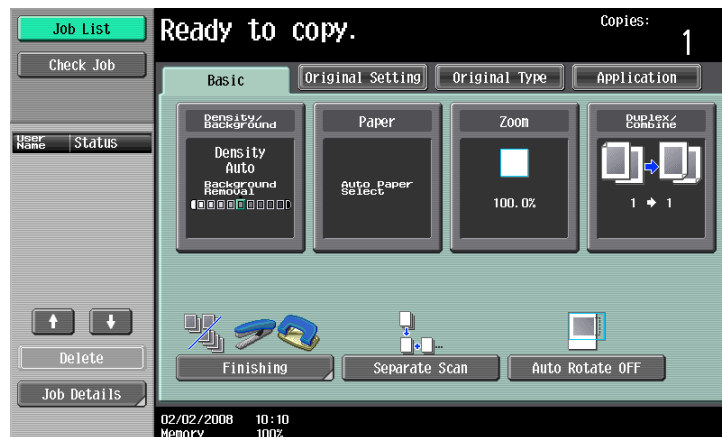

The Duplex/Combine screen appears.

- 2 Touch [1-Sided > 2-Sided] or [2-Sided > 2-Sided].

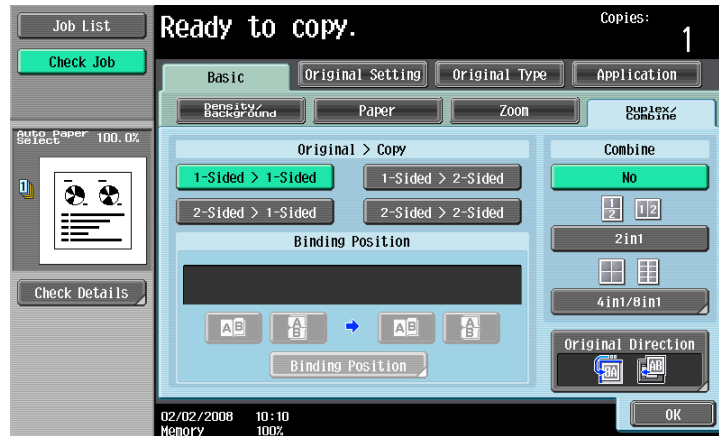

- Specify the position of the binding margin and the orientation of the loaded original, otherwise the copies will not be printed as desired.
- If the binding position for the original is set to "Auto", the position of the binding margin is automatically selected. A binding margin along the long side of the paper is selected if the original length is 11-11/16 inch or less. If the original length is more than 11-11/16 inch, a binding margin along the short side of the paper is selected.
- If "Auto" is selected under "Original Binding Position", the binding margin is set at the top or at the left.
- If the binding position for the copy is set to "Auto", the binding position is automatically determined according to the orientation of the loaded original. If the original length is 11-11/16 inch or less, a binding position along the long side of the paper is selected. If the original length is more than 11-11/16 inch, a binding position along the short side of the paper is selected.
- If the binding position for the copy is set to "Auto", the binding position is set at the top or at the left.

- 3 Touch [Binding Position].

- For a single-sided original, select the binding position for the copy, and then touch [OK].

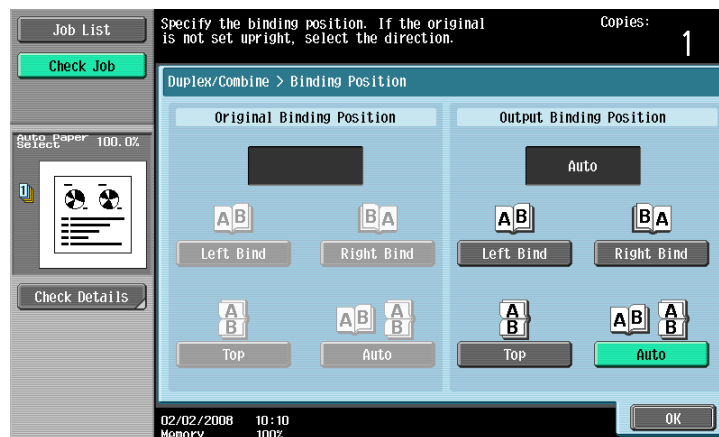

- For a double-sided original, select the binding positions for the original and the copy, and then touch [OK].

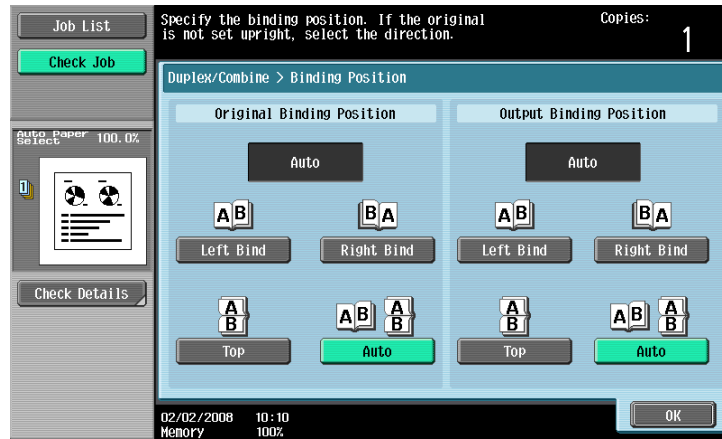

- 4 Touch [Original Direction], select the orientation of the loaded original, and then touch [OK].
 - For details on specifying the original orientation, refer to ["Selecting the original orientation \(Original Direction settings\)" on page 2-22.](#)
- 5 Touch [OK].

The Basic screen appears again.

2.8 Selecting a combined copy setting

Original images of multiple pages (2, 4 or 8 pages) can be combined and printed on a single page, reducing paper use.

The following three combined copy settings are available.



Detail

When select the combined copy setting, copies are produced with the most appropriate zoom ratio (recommended zoom ratio) selected for the original and paper size. The zoom ratio that is selected can be changed manually.



Note

As the factory default, "Auto Display Zoom Ratio" is selected.

The "Auto Zoom for Combine/Booklet" parameter in Utility mode can be set so that the recommended zoom ratios are not used. In that case, specify the zoom ratio manually. For details, refer to "Custom Display Settings" on page 11-17.

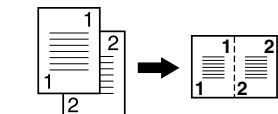
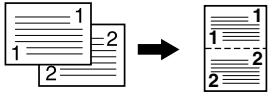
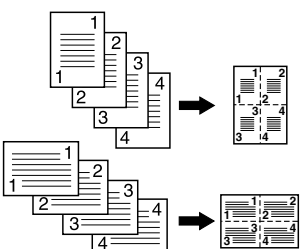
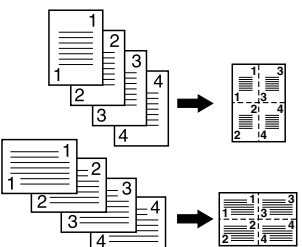
Setting	Description
2in1	<p>Select this setting to print two original pages on one page.</p> <p>Horizontal </p> <p>Vertical </p>
4in1	<p>Select this setting to print four original pages on one page. The page arrangement (Numbering Direction setting) can be specified.</p> <p>Horizontal </p> <p>Vertical </p>

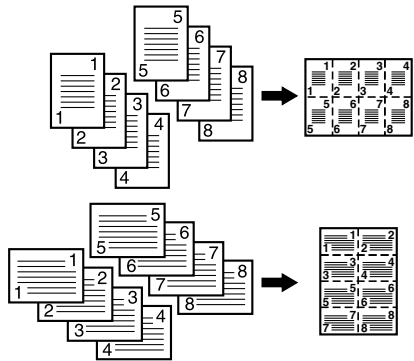
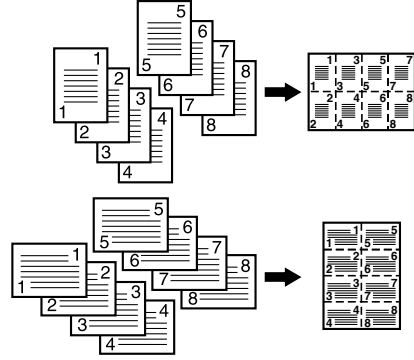
Setting	Description
8in1	<p>Select this setting to print eight original pages on one page. The page arrangement (Numbering Direction setting) can be specified.</p> <p>Horizontal</p>  <p>Vertical</p> 

The following procedure describes how to select a combined copy setting.

2.8.1 Copying multiple original pages onto a single page (combined copy settings)

If a combined copy setting is selected, specify the position of the binding margin and the loading orientation for the original, otherwise the copies may not be printed in the desired arrangement.

For details on specifying the position of the binding margin, refer to ["Selecting the position of the binding margin \("Binding Position" settings\)" on page 2-24](#).

For details on specifying the original orientation, refer to ["Selecting the original orientation \(Original Direction settings\)" on page 2-22](#).

- 1 In the Basic screen, touch [Duplex/Combine].

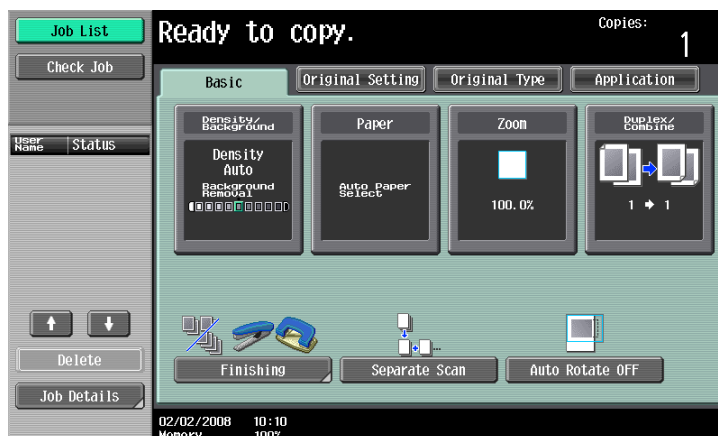

The Duplex/Combine screen appears.

- 2 Select the desired combined copy setting.

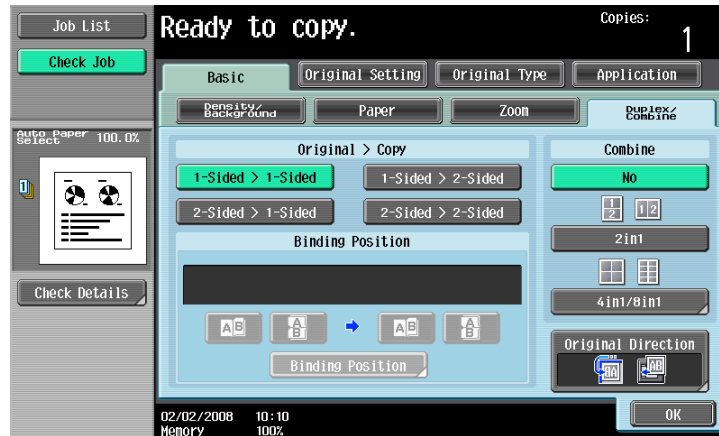

- Select the setting and page arrangement according to the orientation and number of the combined pages.
If "4in1 / 8in1" is selected, whether the "Horizontal" or "Vertical" paper arrangement is selected can be viewed in the touch panel.
However, this appears only if the "Left Pane Display Default" parameter in Utility mode is set to "Check Job Settings".
If "2in1" was selected, the pages will be arranged as shown below.

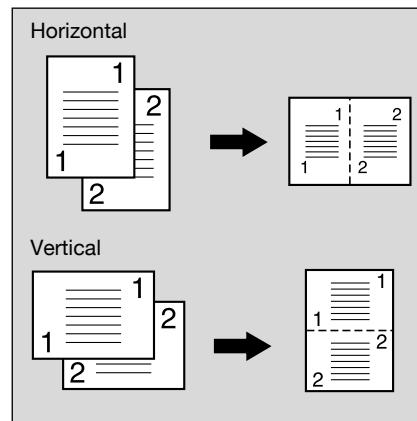

- If "4in1 / 8in1" was selected, the 4in1/8in1 screen appears. Touch [Vertical] or [Horizontal] to select the page arrangement.

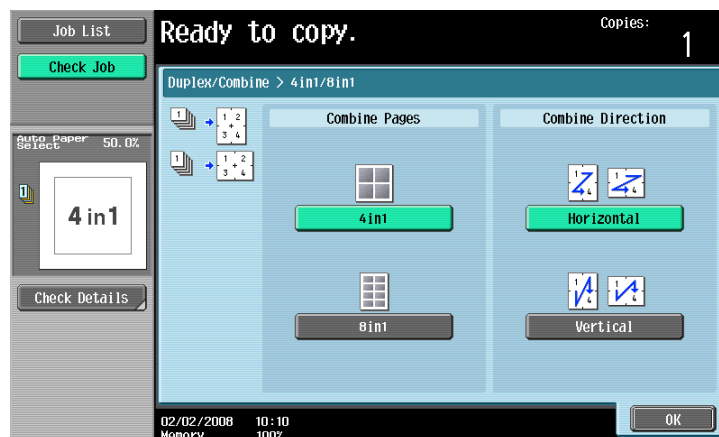

- To cancel the setting, touch [No].

- 3 Touch [OK].

The Basic screen appears again.

2.9 Selecting the quality of the original

2.9.1 Loading originals with small print or photos ("Original Type" settings)





Select the setting for the text and image type of the original to better adjust the copy quality.

The following Original Type settings are available.



Note

As the factory default, "Text/Photo" is selected.

Icon	Description
 Text	Select this setting when copying originals containing only text. The edges of copied text are reproduced with sharpness, providing an image that is easy to read.
 Text/Photo	Select this setting when copying originals containing both text and images.
 Photo	Select this setting to produce better reproductions of halftone original images (photographs, etc.) that cannot be reproduced with the usual settings.
 Dot Matrix Original	Select this setting when copying originals containing only text that appears faint (such as that written with a pencil). The copied text is reproduced so that it is darker, making it easier to read.

The following procedure describes how to select an Original Type setting.

2.9.2 To select an Original Type setting

- 1 Position the original to be copied.
 - For details on positioning the original, refer to ["Feeding the original" on page 2-6](#).
- 2 In the Basic screen, touch [Original Type].

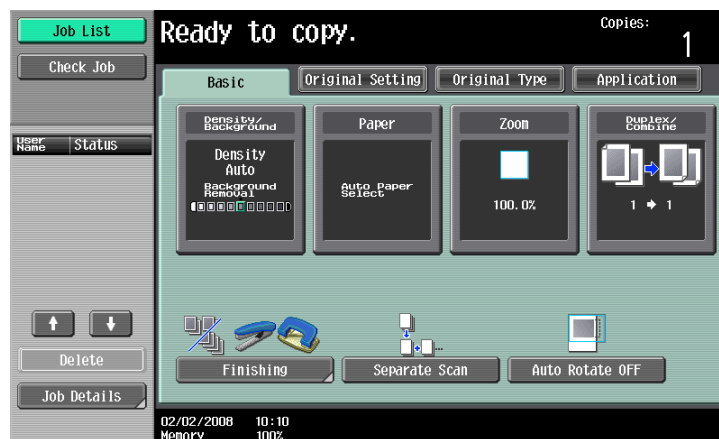

The Original Type screen appears.

- 3 Touch the button for the quality setting most appropriate for the loaded original.

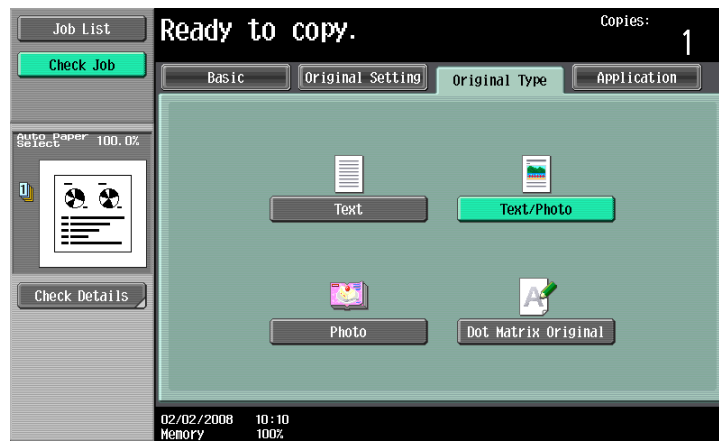

2.10 Selecting the Density settings

Specify the copy density and background density. Adjust to the best density according to the status of the originals.

The following two density adjustments are available.

Function	Description
Density	The print image density can be adjusted to one of nine levels. Each time [Lighter] or [Darker] is touched, the density is lightened or darkened by one level. Touch [Standard] to select the middle setting of the nine levels. Touch [Auto] to automatically adjust the density level according to the original being copied.
Background Removal	The density of the background color of the original can be adjusted to one of nine levels. Each time [Light] or [Dark] is touched, the background density is lightened or darkened by one level. Touch [Standard] to select the middle setting of the nine levels.

The following procedures describe how to specify the density settings.

2.10.1 Adjusting the print density (Density settings)

- 1 In the Basic screen, touch [Density/Background].

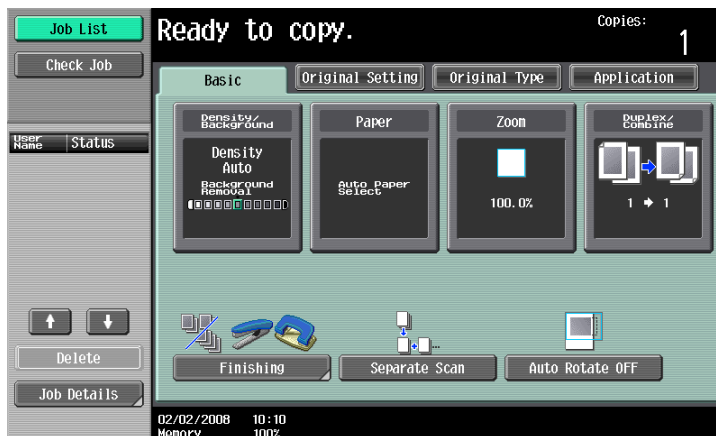

The Density/Background Removal screen appears.

- 2 Select the desired Density setting.

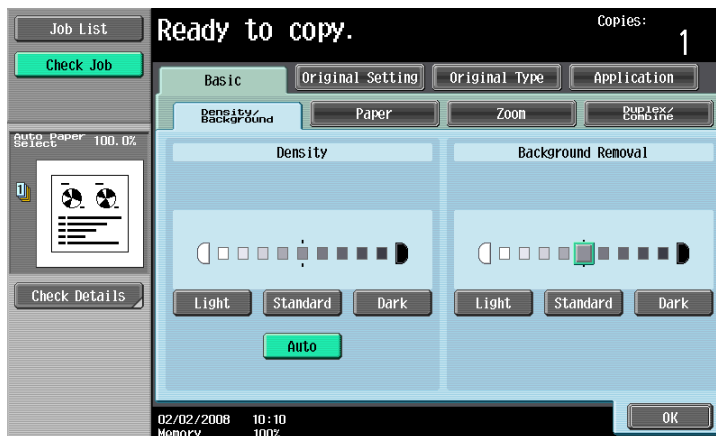

- Each time [Light] or [Dark] is touched, the density is lightened or darkened by one level.
- To select the center setting (default setting), touch [Standard].
- Touch [Auto] to automatically adjust the density level according to the original being copied.
- To cancel the setting and select the default, press the [Reset] key.

- 3 Touch [OK].

2.10.2 Adjusting the background density (Background Removal settings)

- 1 In the Basic screen, touch [Density/Background].

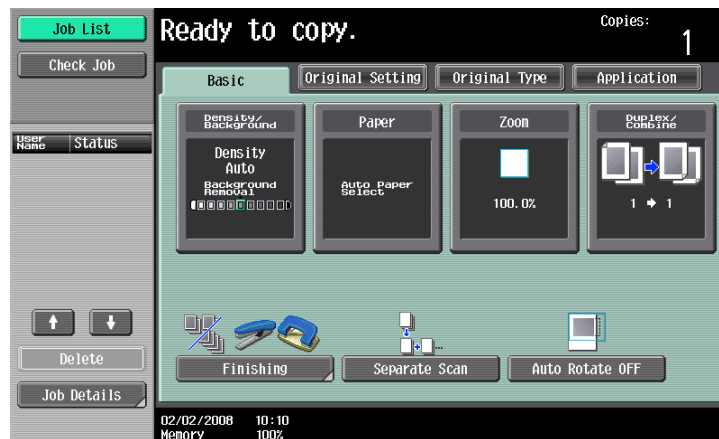

The Density/Background Removal screen appears.

- 2 Select the desired Background Removal setting.

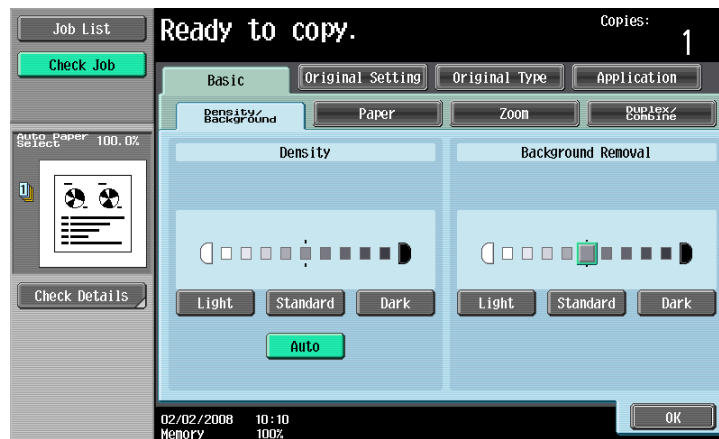

- Each time [Light] or [Dark] is touched, the density is lightened or darkened by one level.
- To select the middle setting of the nine levels (default setting), touch [Standard].
- To cancel the setting and select the default, press the [Reset] key.

- 3 Touch [OK].

2.11 Selecting Finishing settings

Various settings can be selected for sorting and finishing copies fed into the copy output tray.



Note

As the factory default, "Group" is selected.



Detail

If no finisher is installed and all of the following conditions are met, printed copies are fed out and sorted in an alternating crisscross pattern.

8-1/2 × 11- or 5-1/2 × 8-1/2-size paper is used.

Paper of the same size and type is loaded with the orientation in one paper tray and with the orientation in another tray.

The "Auto" Paper setting is selected.

The "Auto" Paper setting is not selected when the "Mixed Original" setting is selected.



Note

From Administrator Settings mode, the machine can be set so that copies are fed out without being shifted when the finisher is installed. As a factory default, the machine is set to shift the copies that are fed out.

For details on specifying settings for shifting copies that are fed out when the finisher is installed, refer to "[System Settings](#)" on page 11-15.

For details on "Fold/Bind", refer to "[Selecting a folding setting](#)" on page 2-65.

When the post inserter is installed with the finisher, the finisher can be operated manually. For details, refer to "[Manually using the finisher](#)" on page 2-73.

Available Finishing Settings

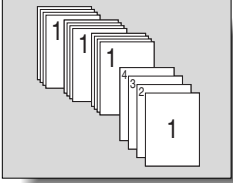
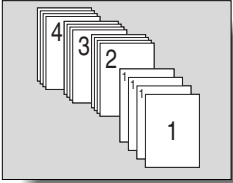
Setting	Description	
Sort	Select this setting to separate each set of a multi-page original.	
Group	Select this setting to separate the copies of each page in a multi-page original.	

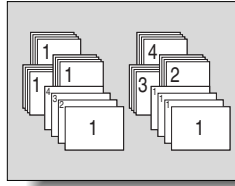
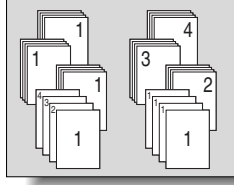
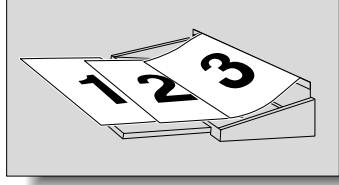
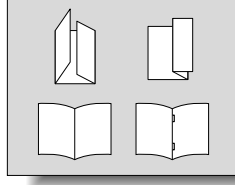
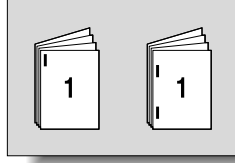
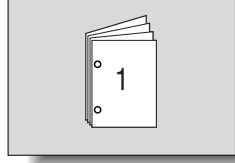
Setting	Description
Offset	<p>If no finisher is installed If the sorting conditions are met, printed copies are fed out and sorted in an alternating criss-cross pattern.</p> 
	<p>If a finisher is installed The copies are fed out and stacked on top of each other with each set shifted to separate it.</p> 
Face Up	<p>The copies are output with their front sides facing up.</p> 
Fold/Bind	<p>Select this setting to fold copies. The copies can also be bound with staples at the same time. The "Fold/Bind" setting can be used if the optional Finisher FS-610 is installed.</p> 
Output Tray	<p>The copies are output to the specified paper tray.</p>
Staple	<p>Select one of these settings to bind the copies with a staple in the corner or with two staples.</p> 
Punch	<p>Holes are punched (2 or 3 holes) in the copies for filing them.</p> 

The following procedures describe how to select Finishing settings.







Reminder

The Staple settings are available only if the optional finisher is installed.

The Punch settings are available only if the punch kit or Z folding unit is installed with the optional finisher.

2.11.1 Separating copies by sets ("Sort" setting)

- ✓ As the factory default, "Group" is selected.
- ✓ If offset sorting is selected while no finisher is installed, printed copies will be fed out and sorted in an alternating  and  pattern if the following conditions are met.
 - 8-1/2 × 11- or 5-1/2 × 8-1/2-size paper is used.
 - Paper of the same size and type is loaded with the  orientation in one paper tray and with the  orientation in another tray.
 - The "Auto" Paper setting is selected.
 - The "Auto" Paper setting is not selected when the "Mixed Original" setting is selected.
- ✓ If offset sorting is selected while a finisher is installed, printed copies are fed out and stacked on top of each other with each set shifted to separate it.

- 1 In the Basic screen, touch [Finishing].

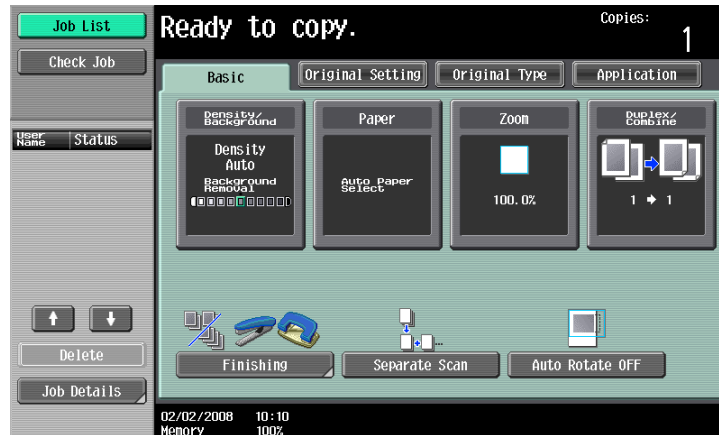

The Finishing screen appears.

- 2 Touch [Sort].







- To separate each set of copies, touch [Yes] under "Offset".

- 3 Touch [OK].

The Basic screen appears again.

2.11.2 Separating copies by pages ("Group" Setting)

- ✓ As the factory default, "Group" is selected.
- ✓ If offset sorting is selected while no finisher is installed, printed copies will be fed out and sorted in an alternating  and  pattern if the following conditions are met.
 - 8-1/2 × 11- or 5-1/2 × 8-1/2-size paper is used.
 - Paper of the same size and type is loaded with the  orientation in one paper tray and with the  orientation in another tray.
 - The "Auto" Paper setting is selected.
 - The "Auto" Paper setting is not selected when the "Mixed Original" setting is selected.

- ✓ If offset sorting is selected while a finisher is installed, printed copies are fed out and stacked on top of each other with each set shifted to separate it.

- 1 In the Basic screen, touch [Finishing].

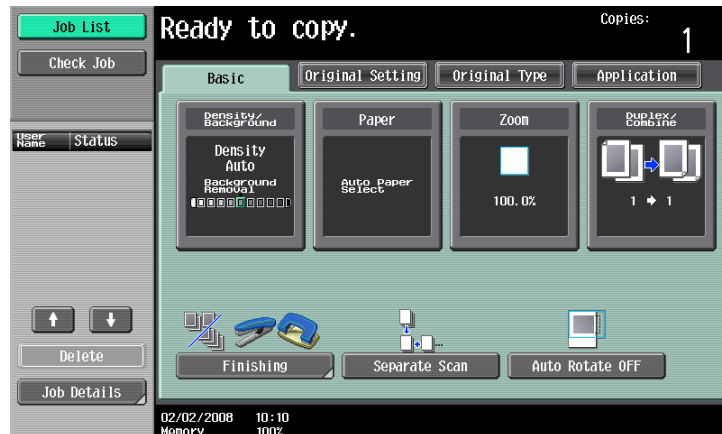

The Finishing screen appears.

- 2 Touch [Group].



- To separate each set of pages, touch [Yes] under "Offset".
- When "Offset" is selected, the following Finishing settings are not available.
Face Up
Staple

- 3 Touch [OK].

The Basic screen appears again.

2.11.3 Selecting the output tray

- ✓ The output tray can be selected only if the optional finisher is installed.

- 1 In the Basic screen, touch [Finishing].
 - When "Offset" is selected, the following Finishing settings are not available.
 - Face Up
 - Staple

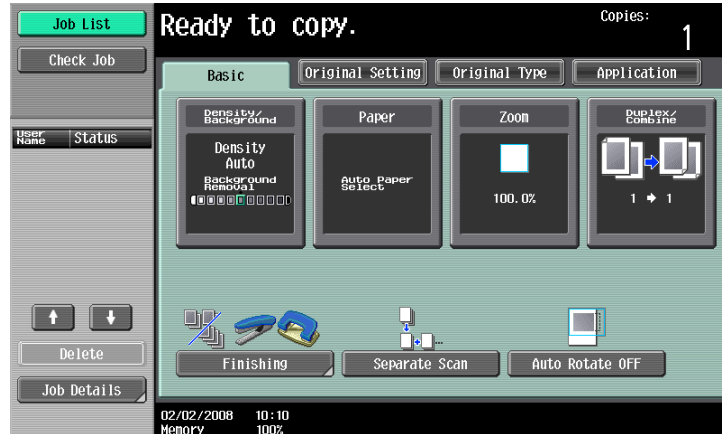

The Finishing screen appears.

- 2 Touch [Output tray].

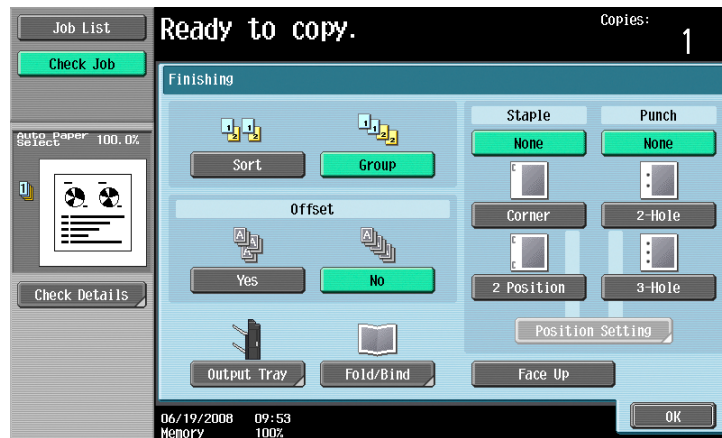

- 3 Select the output tray where copies are to be fed, and then touch [OK].



The Basic screen appears again.

2.11.4 Outputting copies with their front sides facing up (Face Up settings)

The copies are output with their front sides facing up.



Detail

This can be specified for both sort output and group output.

- 1 In the Basic screen, touch [Finishing].

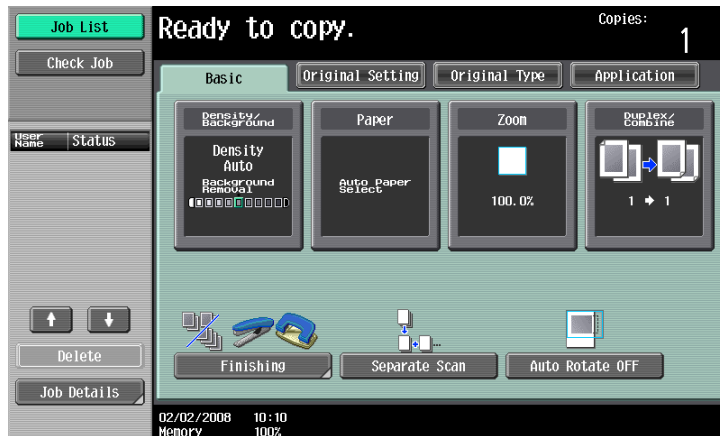

The Finishing screen appears.

- 2 Touch [Face Up].
 - To cancel the settings, touch [Face Up] again.
 - As the factory default, "OFF" is selected. The copies are output with their back sides facing up.
 - The following settings cannot be used together with the "Face Up" setting.
 - Booklet
 - Double-sided copying
 - Center Staple & Fold
 - Half-Fold
 - When "Face Up" is selected, the following Finishing settings are not available.
 - Offset
 - Staple
 - Punch
 - Tri-Fold
 - Z-Fold



- 3 Touch [OK].

The Basic screen appears again.

2.11.5 Stapling copies (Staple settings)

Copies can be fed out stapled either in the corner or at two places.



Detail

In order for the copies to be stapled, all of the following conditions must be met.

The paper width must be between 7-3/16 inch and 12-3/8 inch.

The paper length must be between 5-1/2 inch and 18-1/16 inch.

If the "Mixed Original" setting is selected, all copies must have the same paper width.



Reminder

Copies can be fed out stapled either in the corner or at two places only when the finisher is installed.

Copies can be fed out stapled either in the corner or at two places.

Finisher FS-524/FS-525

Tray	Paper weight	Paper size	Loading capacity
Main finishing tray (Tray 2)	FS-524: 16 lb to 24 lb FS-525: 16 lb to 21-1/4 lb	11 × 17 to 5-1/2 × 8-1/2 , A3 to A5 , Foolscap ^{*1} , 8K , 16K , wide paper (11 × 17W to 5-1/2 × 8-1/2W , A3W to A5W)	2 sheets to 9 sheets binding: 100 sets ^{*2} 10 sheets to 20 sheets binding: 50 sets 21 sheets to 30 sheets binding: 30 sets 31 sheets to 40 sheets binding: 25 sets 41 sheets to 50 sheets binding: 20 sets 51 sheets to 60 sheets binding: 15 sets ^{*3} 61 sheets to 100 sheets binding: 15 sets ^{*3}

^{*1} Foolscap includes the following 4 types: 8-1/8 × 13-1/4 , 8-1/4 × 13 , 8-1/2 × 13 , 8 × 13 , one of which can be selected. For details, contact the service representative.

^{*2} The value is for when using paper of which the length is between 5-7/8 inch and 16-7/16 inch. The value will be 50 sets if the paper length is not within this range.

^{*3} This is the loading capacity when Finisher FS-525 has been installed.

Maximum number of bound pages:

Finisher FS-524: 50 sheets (16 lb to 24 lb)

Finisher FS-525: 100 sheets (16 lb to 21-1/4 lb)

Finisher FS-610

Tray	Paper Weight	Paper Size	Loading Capacity
Main finishing tray (Tray 2)	16 lb to 21-1/4 lb	11 × 17 to 5-1/2 × 8-1/2 , A3 to A5 , Foolscap ^{*1} , 8K , 16K , wide paper (11 × 17W to 5-1/2 × 8-1/2W , A3W to A5W)	2 sheets to 9 sheets binding: 100 sets ^{*2} 10 sheets to 20 sheets binding: 50 sets 21 sheets to 30 sheets binding: 30 sets 31 sheets to 40 sheets binding: 25 sets 41 sheets to 50 sheets binding: 20 sets

^{*1} Foolscap includes the following 4 types: 8-1/8 × 13-1/4 , 8-1/4 × 13 , 8-1/2 × 13 , 8 × 13 , one of which can be selected. For details, contact the service representative.

^{*2} The value is for when using paper of which the length is 16-7/16 inch or less. The value will be 50 sets if the length exceeds 16-7/16 inch.

Maximum number of bound pages: 50 sheets (16 lb to 21-1/4 lb)

- 1 In the Basic screen, touch [Finishing].

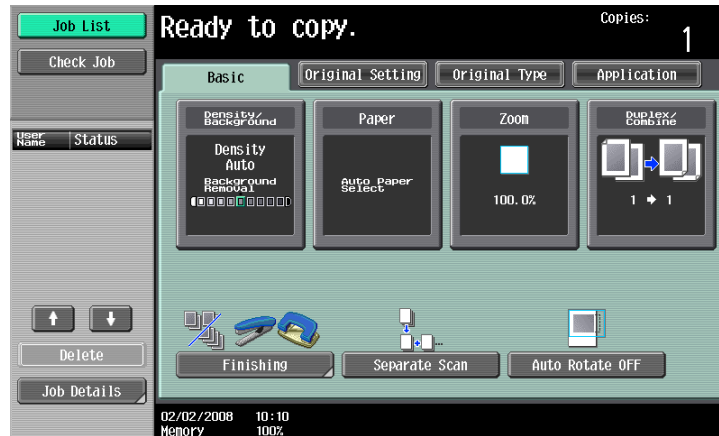

The Finishing screen appears.

- 2 Under "Staple", touch either [Corner] or [2 Position].

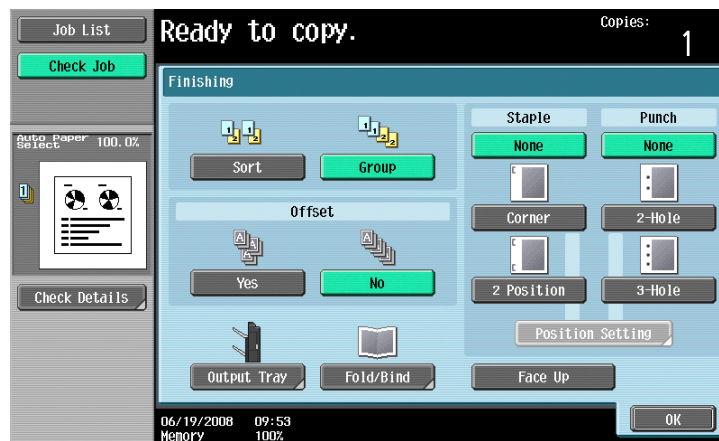

- To cancel the Staple setting, touch [None].
- When a Staple setting is selected, the "Sort" setting is automatically selected.
- The following settings cannot be used together with a Staple setting.
 - Offset
 - Face Up

- 3 Touch [Position Setting].



- Select the stapling position, and then touch [OK].

- When the "2 Position" Staple setting is selected.

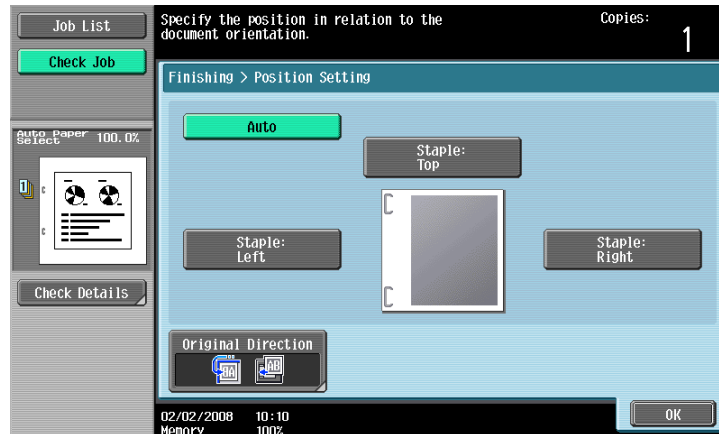

- When the "Corner" Staple setting is selected.

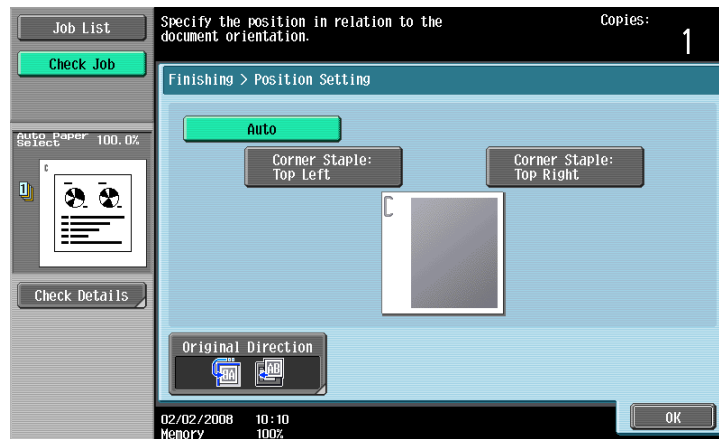

- Touch [Auto] to automatically determine the stapling position according to the orientation of the loaded original. If the original length is 12-3/8 inch or less, the long side of the paper is stapled. If the original length is more than 12-3/8 inch, the short side of the paper is stapled.
- If "Auto" is selected for the stapling position, load the original with the top toward the back of the machine. If the original is loaded in any other orientation, the stapling will not be correctly positioned.
- If "Auto" is selected, the stapling position is set at the top or at the left.
- To cancel the setting and select the default, press the [Reset] key.

4 If desired, touch [Original Direction], and then select the setting appropriate for the original.

- For details on specifying the original orientation, refer to ["Selecting the original orientation \(Original Direction settings\)" on page 2-22.](#)

5 Touch [OK].

The Basic screen appears again.

2.11.6 Punching holes in copies (Punch settings)



Detail

In order to be punch holes in the copies, all of the following conditions must be met.

The paper width must be between 7-3/16 inch and 11-11/16 inch.

The paper length must be between 7-3/16 inch and 17 inch.

If a Punch setting is to be selected, select the orientation in which the original is positioned. If an Original Direction setting is not selected, holes may not be punched in the copies as desired.

For details on specifying the original orientation, refer to ["Selecting the original orientation \(Original Direction settings\)" on page 2-22.](#)



Note

The Punch settings are available only if the punch kit or Z folding unit is installed with the optional finisher.

Tray	Paper Weight	Paper Size
Main finishing tray (Tray 2)	Plain paper (16 lb to 24 lb), thick paper (24-1/4 lb to 34 lb)	2-Hole: 11 × 17 to 5-1/2 × 8-1/2 , A3 to A5 , Foolscap 3-Hole: 11 × 17 , 8-1/2 × 11 , A3 to A4

* Foolscap includes the following 4 types: 8-1/8 × 13-1/4 , 8-1/4 × 13 , 8-1/2 × 13 , 8 × 13 , one of which can be selected. For details, contact the service representative.

- 1 In the Basic screen, touch [Finishing].

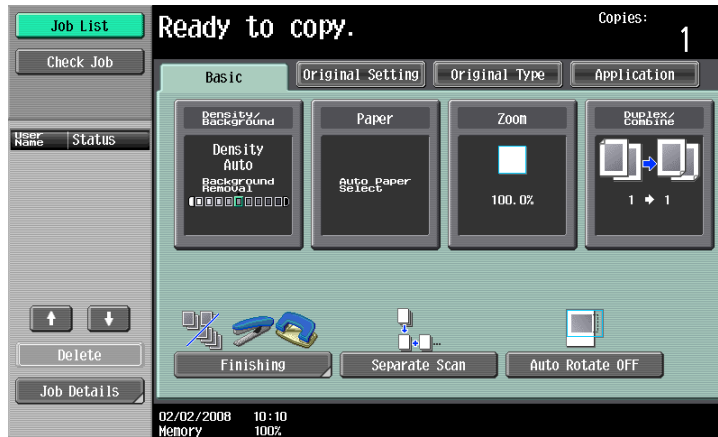

The Finishing screen appears.

- 2 Under "Punch", touch [2-Hole] or [3-Hole].

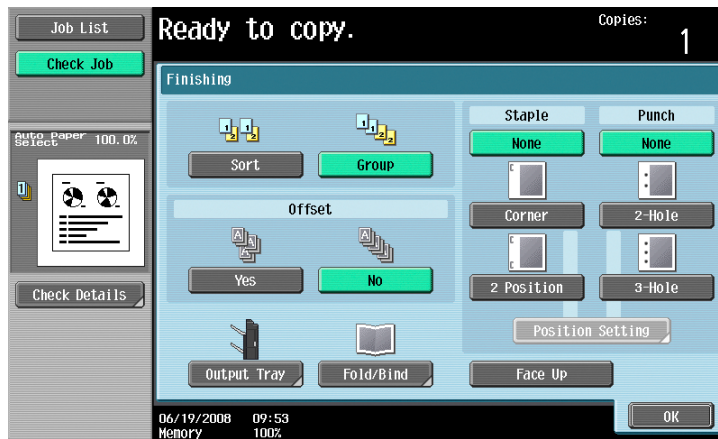

- To cancel the Punch setting, touch [None].
- A Punch setting cannot be used together with the "Face Up" setting.

3 Touch [Position Setting].



- Select the punched hole position, and then touch [OK].

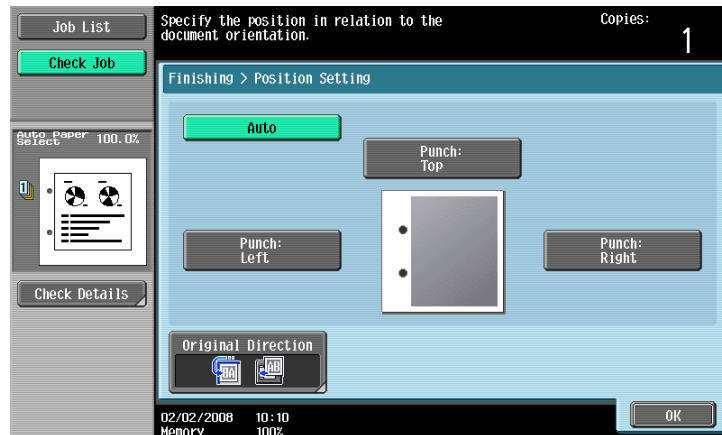

- Touch [Auto] to automatically determine the position of the punched holes according to the orientation of the loaded original. If the original length is 11-11/16 inch or less, the holes are punched along the long side of the paper. If the original length is more than 11-11/16 inch, the holes are punched along the short side of the paper.
 - If "Auto" is selected for the stapling position, load the original with the top toward the back of the machine. If the original is loaded in any other orientation, the stapling will not be correctly positioned.
 - If "Auto" is selected, the punched hole position is set at the top or at the left.
 - To cancel the setting and select the default, press the [Reset] key.
- 4** If desired, touch [Original Direction], and then select the setting appropriate for the original.
- For details on specifying the original orientation, refer to ["Selecting the original orientation \(Original Direction settings\)" on page 2-22.](#)
- 5** Touch [OK].
- The Basic screen appears again.

2.12 Selecting a folding setting

By installing optional equipments, copies can be folded, or folded and bound with staples at the same time, and then fed out. Available settings differ depending on the optional equipments installed.

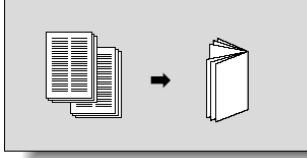
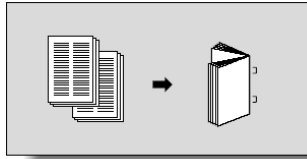
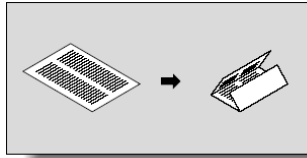
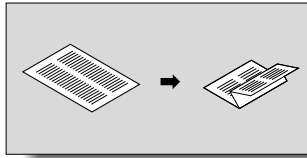
Setting	Description	Compatible models
Half-Fold	Select this setting to fold copies in half before feeding them out. (Refer to page 2-65.) 	FS-610
Center Staple & Fold	Select this setting to staple copies at two places along the center, then fold the copies in half before feeding them out. (Refer to page 2-67.) 	FS-610
Tri-Fold	Select this setting to fold copies in three before feeding them out. (Refer to page 2-68.) 	FS-610
Z-Fold	Select this setting to fold copies in half along the center, and additionally mountain-fold one of the halves before feeding them out. 	FS-524 FS-525 FS-610



Note

Copies can be folded in half or in three or bound at the center only if Finisher FS-610 is installed.

Z-folding is available when the Z folding unit is installed with the finisher. For details, refer to "Z-Folding and outputting papers ("Z-Fold" setting)" on page 2-70.

2.12.1 Folding copies in half ("Half-Fold" setting)

Finisher FS-610

Paper weight	Paper size
Plain paper (16 lb to 24 lb)	Standard sizes: 11 × 17 8-1/2 × 14 8-1/2 × 11 A3 B4 A4 8K wide paper (11 × 17W 8-1/2 × 11W A3W B4W A4W Custom sizes: 8-1/4 × 11 to 12-3/8 × 18-1/16

Maximum number of folded sheets	Paper capacity
3 sheets	When folding 3 sheets (21-1/4 lb): 25 sets or less (with a paper length of 11-3/4 inch or less) 33 sets or less (others)

1 In the Basic screen, touch [Finishing].

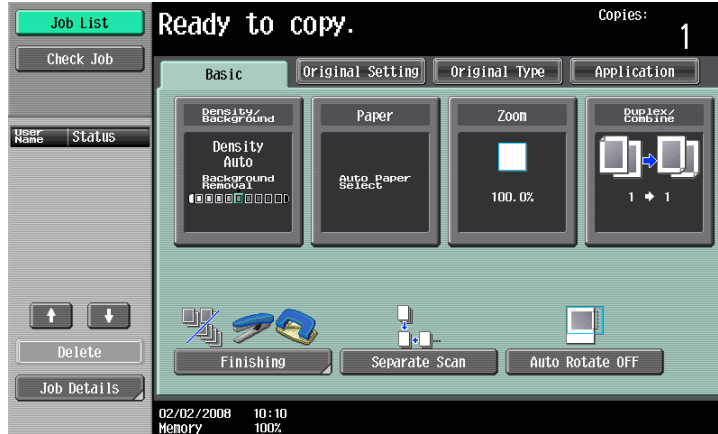

The Finishing screen appears.

2 Touch [Fold/Bind].



The Fold/Bind screen appears.

3 Touch [Half-Fold].

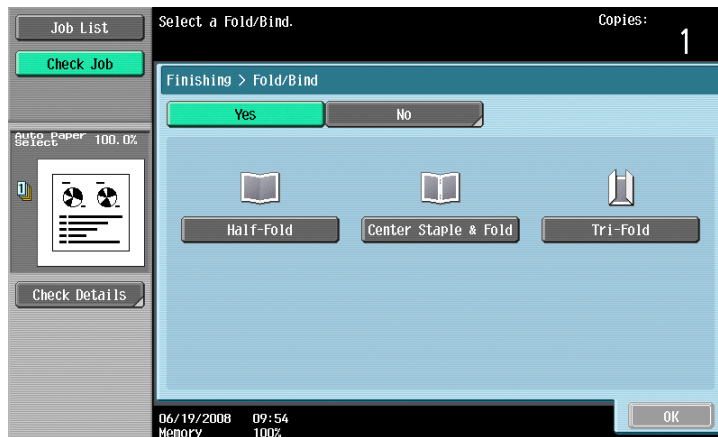













- As the factory default, the "Booklet" function is automatically specified when "Half-Fold" is selected.
- To cancel the "Half-Fold" setting, touch [No] or the button for a different setting.

- 4 Touch [OK], and then touch [OK] again.
The Basic Screen appears again.

2.12.2 Binding copies at the center ("Center Staple & Fold" setting)

Finisher FS-610

Paper weight	Paper size	Maximum number of bound sheets
16 lb to 21-1/4 lb	Standard sizes: 11 × 17  , 8-1/2 × 14  , 8-1/2 × 11  , A3  , B4  , A4  , 8K  , wide paper (11 × 17W  , 8-1/2 × 11W  , A3W  , B4W  , A4W ) Custom sizes: 8-1/4 × 11 to 12-3/8 × 18-1/16	20 sheets
21-1/2 lb to 24 lb		16 sheets

- 1 In the Basic screen, touch [Finishing].

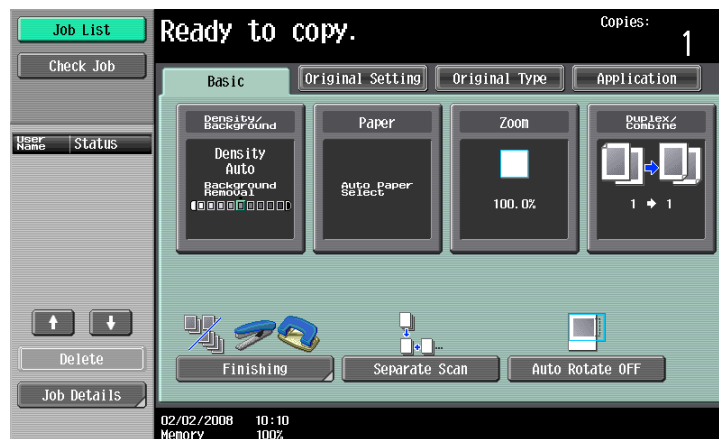

The Finishing screen appears.

- 2 Touch [Fold/Bind].



The Fold/Bind screen appears.

3 Touch [Center Staple & Fold].

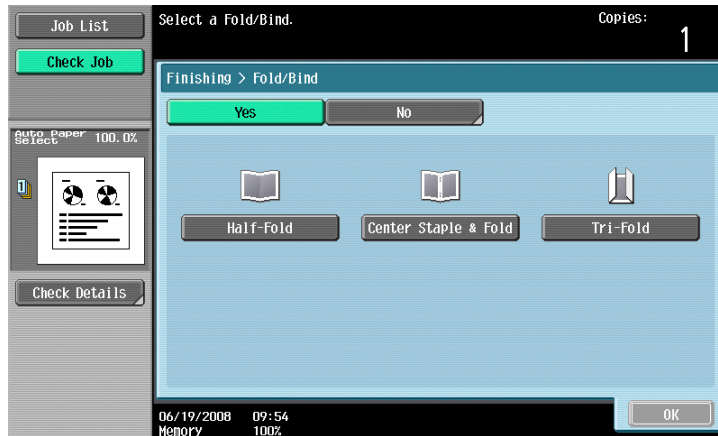



- If a cover sheet is added with the "Cover Sheet" function, the cover sheet (53-1/4 lb) cannot be stapled.
- When the "Center Staple & Fold" setting is selected, the following factory default settings are automatically selected.
 - 1-Sided > 2-Sided
 - Booklet
 - Recommended zoom ratio (64.7%) when the "Booklet" function is selected
- When the "Center Staple & Fold" setting is selected, the following Finishing settings are not available.
 - Group
 - Offset
 - Staple
 - Punch
 - Face Up
- To cancel the "Center Staple & Fold" setting, touch [No] or the button for a different setting.

4 Touch [OK], and then touch [OK] again.
The Basic screen appears again.

2.12.3 To fold copies in three ("Tri-Fold" setting)

Finisher FS-610

Paper weight	Paper size	Maximum number of tri-folded sheets
16 lb to 21-1/4 lb	8-1/2 × 11  , A4  , 16K 	3 sheets
21-1/2 lb to 24 lb		1 sheet

Number of folded sheets	Maximum number of sets
1 sheet	50 sets or less



Detail

When copies are to be folded in three, settings can be specified to select whether the printed side is on the inside or the outside. For details on selecting the setting, refer to "[Copier Settings](#)" on page 11-18.

- 1 In the Basic screen, touch [Finishing].

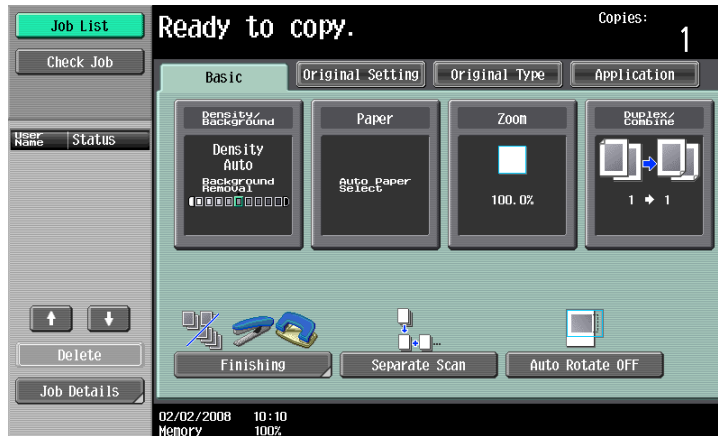

The Finishing screen appears.

- 2 Touch [Fold/Bind].

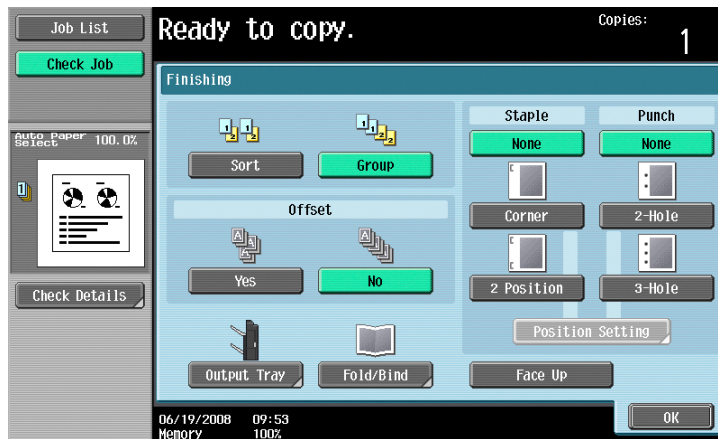

The Fold/Bind screen appears.

- 3 Touch [Tri-Fold].

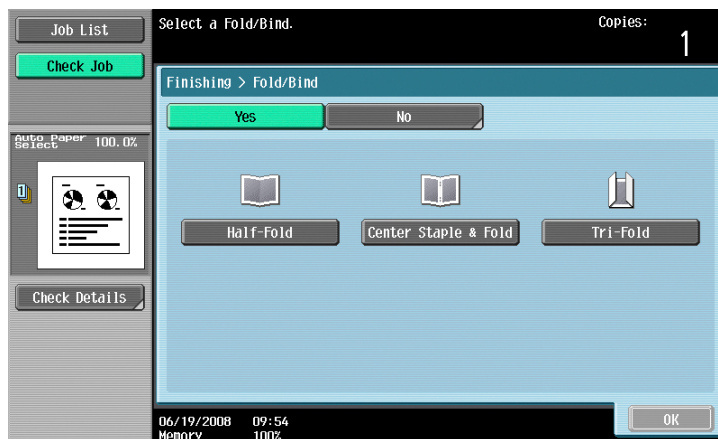

- When the "Tri-Fold" setting is selected, the following Finishing settings are not available.
Group
Offset
Staple
Punch
Face Up
- To cancel the "Tri-Fold" setting, touch [No] or the button for a different setting.

- 4 Touch [OK], and then touch [OK] again.
The Basic screen appears again.

2.12.4 Z-Folding and outputting papers ("Z-Fold" setting)

Copies can be Z-folded and output. In addition, originals of mixed sizes can be Z-folded and output in the same specified paper size.

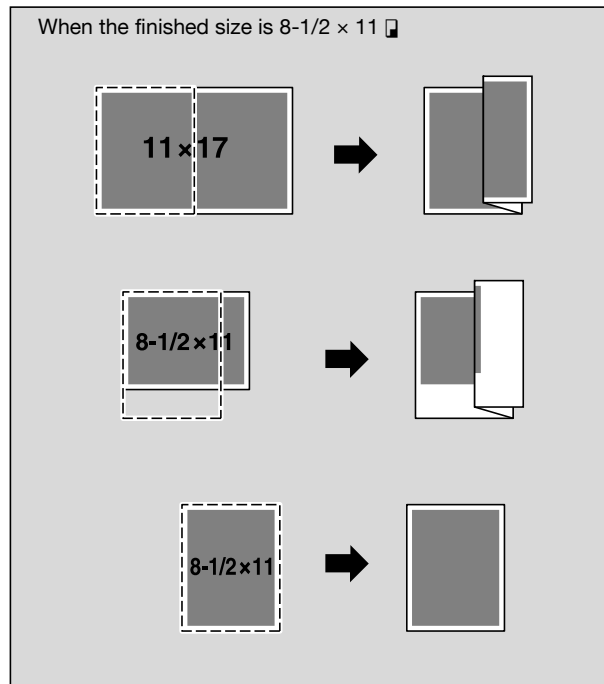

Detail

The Z-folding function is not available in the following cases.

When the original size and output paper size are the same.

When a paper size on which a part of the original image will be lost is selected.



Note

Punching or stapling can be carried out with Z-folding before feeding the copies out.



Detail

For details on setting the mixed (size) originals, refer to "Copying originals of mixed sizes ("Mixed Original" setting)" on page 2-18.

Finisher FS-524/FS-525/FS-610 and Z folding unit

Paper weight	13-1/4 lb to 24 lb
Paper size	11 x 17 ☐, 8-1/2 x 14 ☐, A3 ☐, B4 ☐, 8K ☐
Z-folded & stapled copies*	5 sheets
Paper capacity	30 sheets or less

* Can be specified when the output paper size is 11 x 17, A3☐, B4☐, 8K ☐.



Note

Z-folding multiple overlapped papers as one unit is not possible.



Detail

When loading the originals into ADF, load them in the orientation where the side to be folded is on the right.

When placing the original on the original glass, place it in the orientation where the side to be folded is on the left.

- 1 In the Basic screen, touch [Finishing].

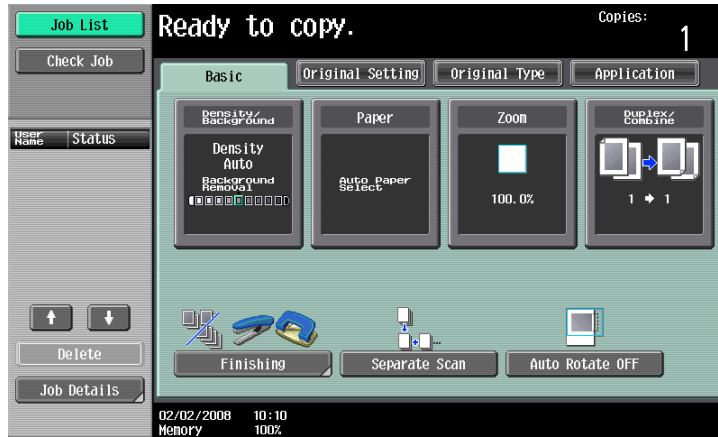

The Finishing screen appears.

- 2 Touch [Fold/Bind].

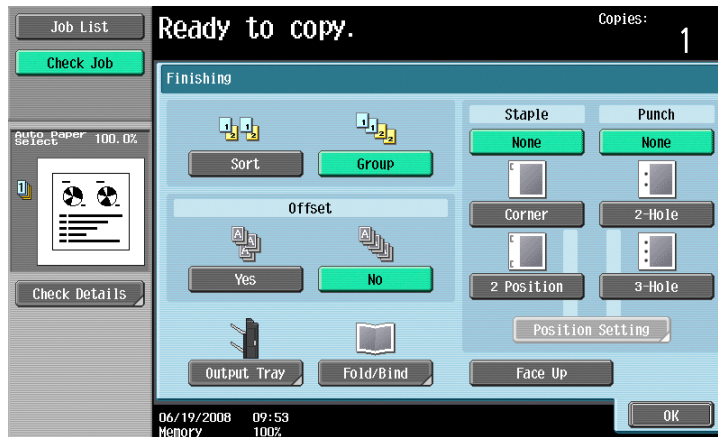

The Fold/Bind screen appears.

- 3 Touch [Z-Fold].

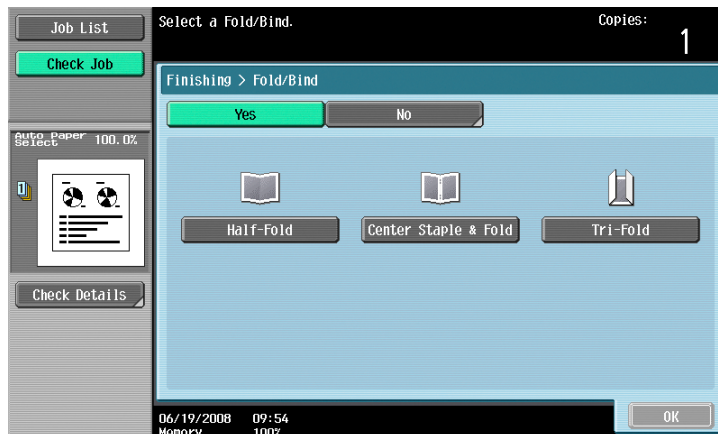

- To cancel the "Z-Fold" setting, touch [Z-Fold] or the button for a different setting.

- 4 Touch [OK], and then touch [OK] again.

2.13 Manually using the finisher

If the post inserter is installed onto the finisher, the finisher can be operated manually by using the control panel of the post inserter.

The following Finishing settings are available with each of the option configurations.

Finisher FS-524/FS-525 and post inserter

"Corner" Staple, "2 Position" Staple

Finisher FS-610 and post inserter

- "Corner" Staple, "2 Position" Staple
- Center Staple & Fold
- Tri-Fold

Finisher FS-524/FS-525, post inserter and punch kit

- "Corner" Staple, "2 Position" Staple
- Punch settings

Finisher FS-610, post inserter and punch kit



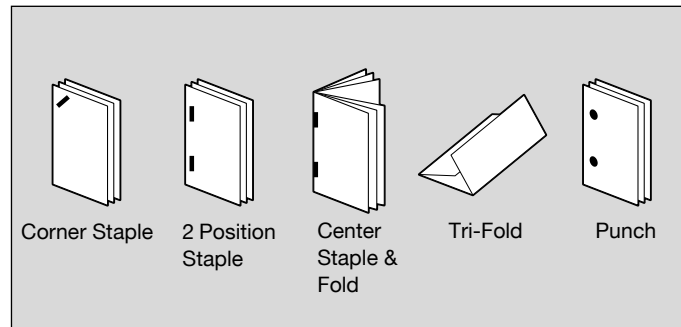











- "Corner" Staple, "2 Position" Staple
- Center Staple & Fold
- Tri-Fold
- Punch settings







Reminder

Only load paper into the lower tray. Do not use the upper tray.

	Paper weight	Paper size	Number of sheets	Output tray
"Corner" Staple, "2 Position" Staple	Plain paper (16 lb to 24 lb)	Standard sizes: 11 × 17 to 5-1/2 × 8-1/2 , A3 to A5 , Foolscap ^{†1} , 8K , 16K , wide paper (11 × 17W to 5-1/2 × 8-1/2W , A3W to A5W) Custom sizes: 7-3/16 × 5-1/2 to 12-3/8 × 18-1/16	Finisher FS-524 50 sheets (16 lb to 24 lb)	Main finishing tray (Tray 2)
			Finisher FS-525 100 sheets (16 lb to 21-1/4 lb)	
			Finisher FS-610 50 sheets (16 lb to 21-1/4 lb) 16 sheets (21-1/2 lb to 24 lb)	
Punch settings	Plain paper (16 lb to 24 lb) Thick paper (24-1/4 lb to 34 lb)	2 holes: 11 × 17 to 5-1/2 × 8-1/2 , Foolscap ^{†1} , A3 to A5 3 holes: 11 × 17 to 8-1/2 × 11 , A3 to A4	200 sheets	Main finishing tray (Tray 2)

	Paper weight	Paper size	Number of sheets	Output tray
Center Staple & Fold ²	Plain paper (16 lb to 21-1/4 lb)	Standard sizes: 11 × 17  , 8-1/2 × 14  , 8-1/2 × 11  , A3  , B4  , A4  , 8K  , wide paper (11 × 17W  , 8-1/2 × 11W  , A3W  , B4W  , A4W )	20 sheets (16 lb to 21-1/4 lb) 16 sheets (21-1/2 lb to 24 lb)	Booklet tray
Tri-Fold ²	Plain paper (16 lb to 24 lb)	8-1/2 × 11  , A4  , 16K 	3 sheets (16 lb to 21-1/4 lb) 1 sheet (21-1/2 to 24 lb)	Booklet tray

^{*1} Foolscap includes the following 4 types: 8-1/8 × 13-1/4 , 8-1/4 × 13 , 8-1/2 × 13 , 8 × 13 , one of which can be selected. For details, contact the service representative.

^{*2} Can be used only with Finisher FS-610.



Detail

When manually performing the hole-punching operation from the post inserter control panel, only two holes can be punched.

Names of control panel parts

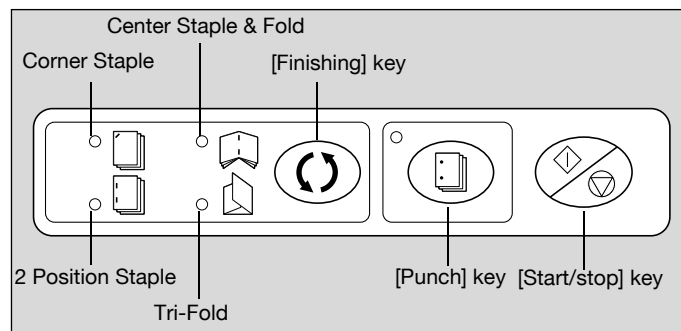

Finishing

- 1 Load the paper into the lower tray of the post inserter.
 - If the "Corner" or "2 Position" Staple settings are to be used, load the paper face up
 - If a Punch setting is to be used, load the paper face up.
 - If the paper is to be stapled and folded at the center, load the paper so that the side that is to be the front when bound is face up.
 - If the paper is to be folded in three, load the paper so that the side that is to be the outside when folded in three is face up.
 - The loaded paper will be finished into one set.

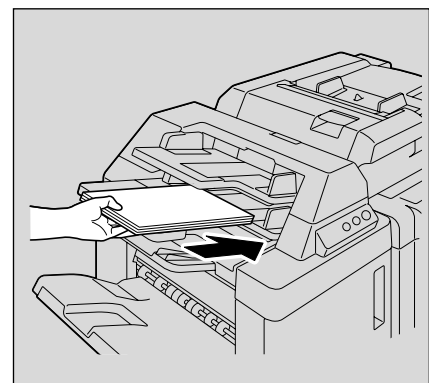

- 2 Slide the paper guides to fit the size of the paper.

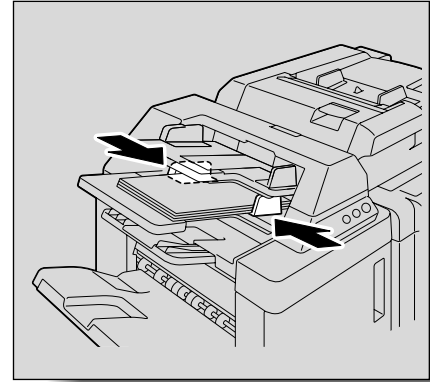

- 3 Press the [Finishing] key or [Punch] key, and then select the desired Finishing settings.
 - When the "Corner" or "2 Position" Staple settings, or the "Center Staple & Fold" or "Tri-Fold" setting is selected, press the [Finishing] key, and the indicator lights up. When a Punch setting is selected, press the [Punch] key, and the indicator lights up.
 - A Punch can be selected at the same time as the "Corner" or "2 Position" Staple setting. If the settings are selected at the same time, the indicator lights up when the [Finishing] key is pressed. When only a Punch setting is selected, all indicators except the one on the [Punch] key go off.
- 4 Press the [Start/Stop] key.
 - Press the [Start/Stop] key during an operation to stop the operation.

2.14 Selecting not to rotate the image

Copies can be printed with the image not rotated to fit the orientation of the loaded paper.

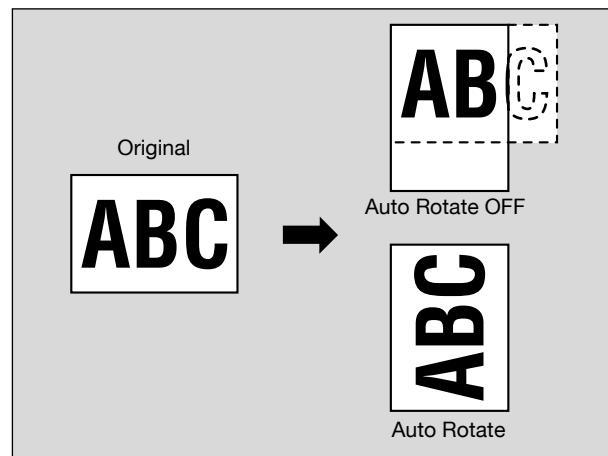

Note

Depending on the paper size and zoom ratio, some parts of the image may be lost.

→ In the Basic screen, touch [Auto Rotate OFF].

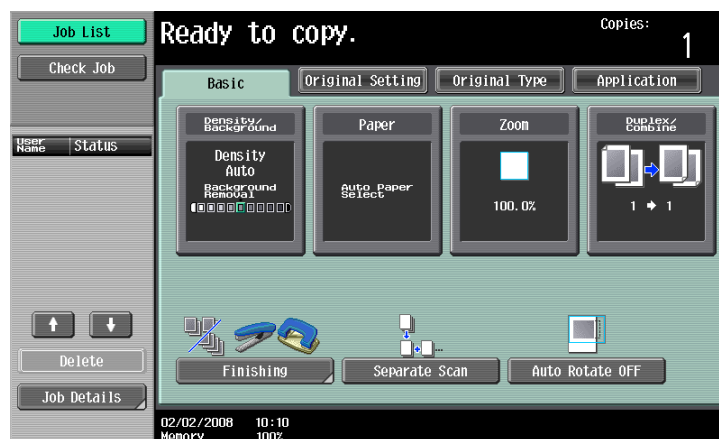

2.15 Scanning the next original to be copied while a copy job is being printed (next job reservation)

The settings for the next copy job can be specified and the original can be scanned while a copy job is being printed so that it can be printed once the current copy job is finished.

- ✓ Up to 51 copy jobs, including the current copy job, can be reserved.
- ✓ A copy job can be reserved after scanning of the loaded original is finished. The next job cannot be reserved while an original is being scanned.
- ✓ To delete a reserved copy job, touch [Job List] in the left panel, and then touch [Job Details]. For details, refer to ["Deleting a job" on page 10-6](#).

1 When the message "Ready to accept another job." appears while the current job is being printed, an original can be loaded, and copy settings can be specified for the next copy job.

- For details on positioning the original, refer to ["Feeding the original" on page 2-6](#).

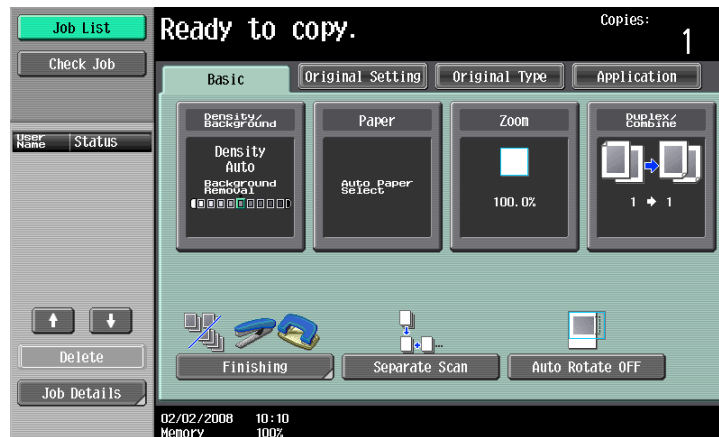

- If the "Copy Operating Screen" parameter in Utility mode is set to "Yes", touch [Next Copy Job] while printing to display the Basic screen.

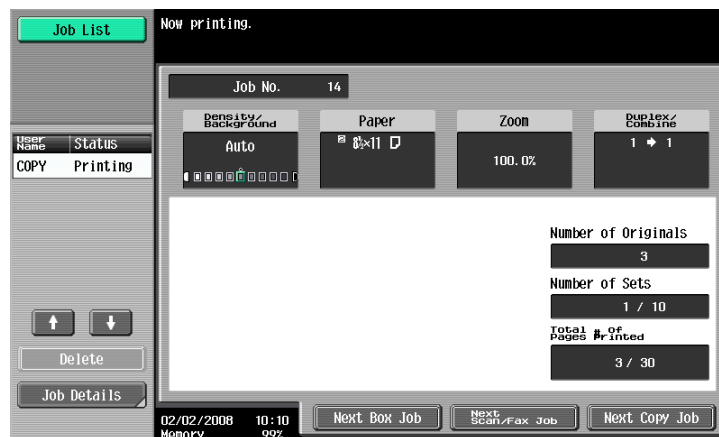

- For details on specifying the screen that appears while printing, refer to ["Custom Display Settings" on page 11-17](#).

2 Press the [Start] key.

3 After the current copy job is finished, the next copy job begins.

2.16 Temporarily stopping scanning/printing

Follow the procedure described below to temporarily stop scanning the original and stop the printing operation.

- ✓ If an original is being scanned for a job, pressing the [Stop] key stops scanning.
- ✓ For details on deleting a temporarily stopped job, refer to ["Deleting a paused job" on page 2-79](#).

- 1 Press the [Stop] key while an original is being scanned or a job is being printed.
Scanning/printing stops.

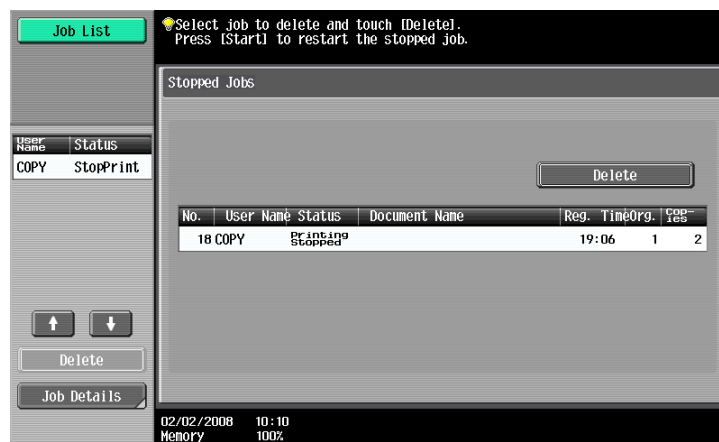

The Stopped Jobs screen appears.

- 2 To continue all stopped jobs, press the [Start] key.

2.17 Deleting a paused job

Follow the procedure described below to delete a temporarily stopped job.

- ✓ For details on temporarily stopping a job being scanned or printed, refer to "[Temporarily stopping scanning/printing](#)" on page 2-78.
- ✓ Select only one job at a time to be deleted.
- ✓ To continue a temporarily stopped job, press the [Start] key.

- 1 Press the [Stop] key while an original is being scanned or a job is being printed.

Scanning/printing stops.
The Stopped Jobs screen appears.



- 2 Select the job to be deleted, and then touch [Delete].

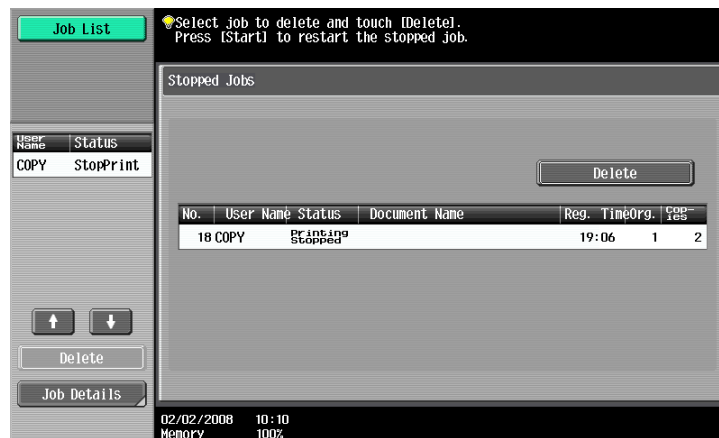

The selected job is deleted.

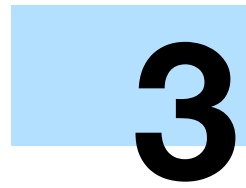

Additional copy operations

3 Additional copy operations

3.1 Checking the Copy Settings (Check Job)

From the Check Job Details screens, the current copy settings can be checked and changed if desired.

3.1.1 To check the settings

- 1 Touch [Check Job] in the left panel, and then touch [Check Details].
The Check Job Settings screen appears.

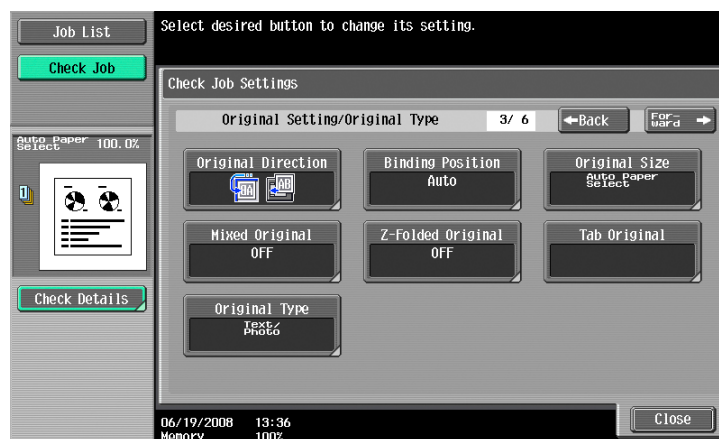
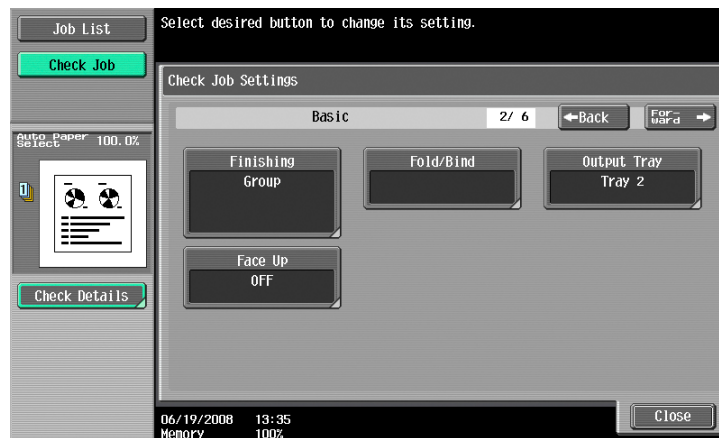

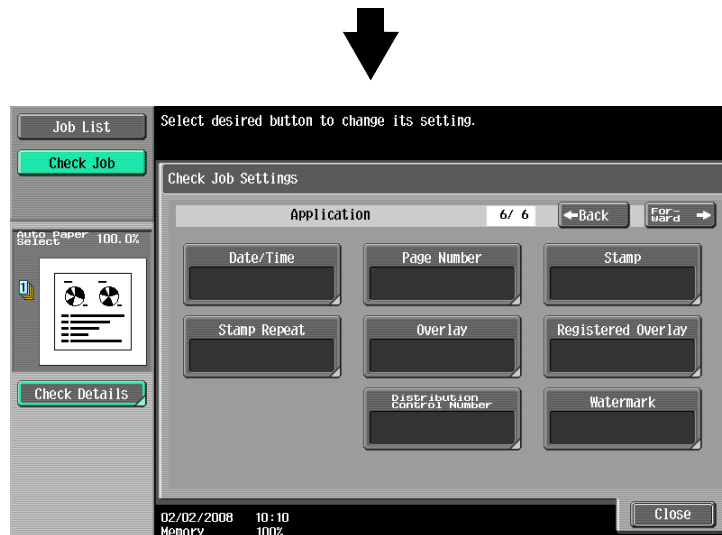
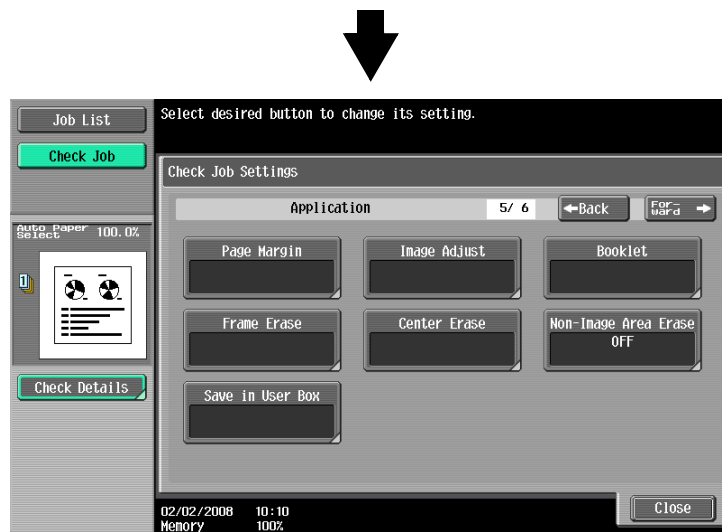
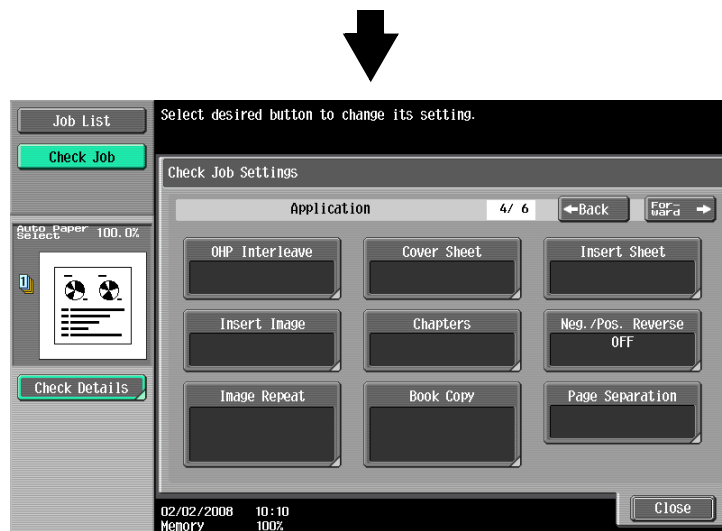

- 2 After checking the settings, touch [Close].

The Basic screen appears again.



Detail

There are six Check Job Settings screens. The number of the currently displayed screen appears to the right of the screen title.

To display the previous screen, touch [←Back]. To display the next screen, touch [Forward→].

If the setting for a function has been changed from the default, the button for that function appears with a colored box around it.

3.1.2 To change the settings

- 1** Touch [Check Job] in the left panel, and then touch [Check Details].
- 2** Touch [←Back] or [Forward→] until the button for the function to be changed is displayed.
- 3** Touch the button for the function whose setting is to be changed.
The screen for specifying the setting appears.
- 4** Follow the appropriate procedure to change the setting.

3.2 Printing a proof to check the settings (Proof Copy)

Before printing a large number of copies, a single proof copy can first be printed so that it can be checked. This prevents copy errors from occurring.

- 1 Position the original to be copied.
 - For details on positioning the original, refer to ["Feeding the original" on page 2-6](#).
- 2 Select the desired copy settings.
 - When printing a proof copy, specify multiple copies.
- 3 Press the [Proof Copy] key.

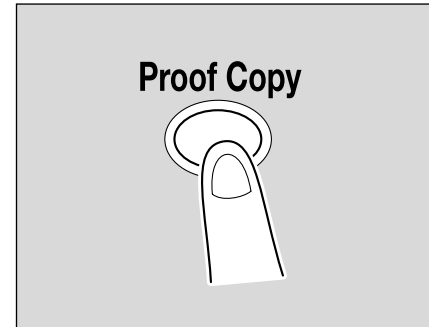

- 4 If the original was placed on the original glass, touch [Finish], and then press the [Start] key.
 - If the original was loaded into the ADF, printing of the proof copy begins without the screen appearing confirming that scanning of the original is finished.
 A single proof copy is printed.
- 5 Check the proof copy.
 - If the proof copy was printed as desired, continue with step 8.
 - To change the copy settings, continue with step 6.
- 6 Touch [Change Setting] in the screen that appeared when the proof copy was printed.

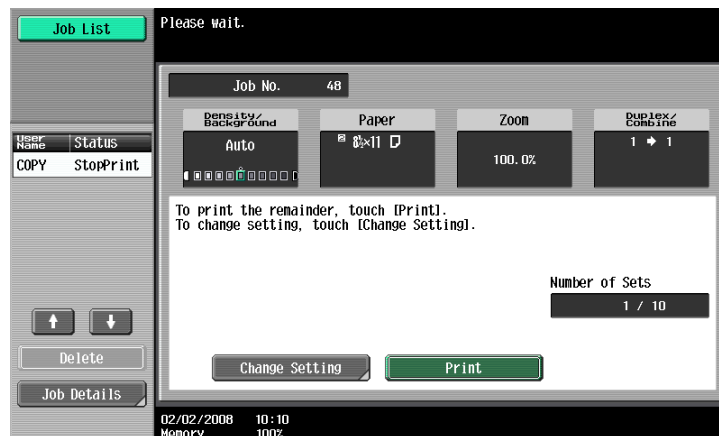

- To stop copying while the proof copy screen is displayed, press the [Reset] key or the [C] (clear) key. Otherwise, select the proof copy job to be stopped from the list of jobs in the left panel, and then touch [Delete]. In the screen that appears, requesting confirmation to delete the job, touch [Yes], and then touch [OK].
- If no operation is performed within the specified length of time while this screen is displayed, the copy job being proofed is registered as a stored job and the Basic screen appears again. Jobs are registered as stored jobs under the following conditions.
When the automatic system reset operation is performed
After one minute (when "System Auto Reset" is set to "OFF")
For details on stored jobs, refer to [page 10-11](#). If "System Auto Reset" is set to "OFF", the job is stored if no operation is performed for 1 minute.

- For details on the automatic system reset operation, refer to "[Automatically conserving energy \(Sleep mode\)](#)" on page 1-33.
- The number under "Number of Sets" in the screen that appeared when a proof copy is printed indicates the number of sets printed as proof copies/total Number of Sets specified.
- The number under "Total # of Pages Printed" in the screen that appeared when a proof copy is printed indicates the number of copies printed as proof copies/the number of pages printed in the proof copy.

7 In the screen allowing you to change the settings, change the copy settings as desired, and then touch [OK].

To cancel changes to the settings, touch [Cancel].

- If the copy settings cannot be changed, stop printing the proof copy. Next, press the [Reset] key to cancel the copy settings, and then specify the desired settings.
- To stop copying while the screen for changing the settings is displayed, select the proof copy job to be stopped from the list of jobs in the left panel, and then touch [Delete]. In the screen that appears, requesting confirmation to delete the copy program, touch [Yes], and then touch [OK].
- To cancel changes to the settings in the screen for changing the settings, press the [Reset] key while the screen for changing the settings is displayed to reset the settings to those specified in step 2.
- The number beside "Copies" in the screen for changing the settings is the number of copies that will be printed when [Finish] is touched.



8 Press the [Proof Copy] key to print another proof copy.

- To stop the proof copy while scanning or printing, perform the operation described in "[Temporarily stopping scanning/printing](#)" on page 2-78.

9 Touch [Print].

The remaining copies are queued as a copy job.

3.3 Interrupting a copy job (Interrupt mode)

The current jobs can be temporarily interrupted so an original can be copied with different copy settings. This is convenient for quickly making a copy.



Detail

For details on making a copy after printing of the current job is finished, refer to *"Increasing printing priority" on page 10-14*.

- 1 Position the original to be copied.
 - For details on loading the original, refer to *"Loading the original into the ADF" on page 2-6*.
- 2 Press the [Interrupt] key.
 - If a job is being printed, the message "The job is stopping." appears.
The indicator on the [Interrupt] key lights up in green and printing of the current job stops.
 - ? What settings are selected when the [Interrupt] key is pressed?
 - When the [Interrupt] key is pressed, all functions and settings are reset to their defaults.
 - ? Why is the [Interrupt] key not available?
 - The [Interrupt] key cannot be pressed while an original is being scanned.
- 3 Select the desired copy settings.
- 4 Press the [Start] key.

Printing for the interrupting job begins.
- 5 After the interrupting job has finished printing, press the [Interrupt] key.

The indicator on the [Interrupt] key goes off.
The copy settings return to those specified before printing was interrupted.

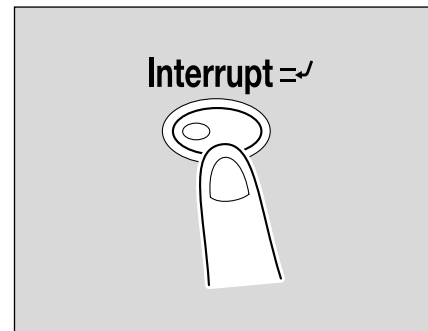

Note

If the interrupting job is cancelled, printing for the interrupted job automatically restarts.

3.4 Registering copy programs (Mode Memory)

Frequently used copy settings can be stored together as a program to easily be recalled. A maximum of 30 programs can be registered.

A name of up to 16 characters can be specified for the registered copy programs.



Note

If the optional hard disk is installed, a maximum of 100 copy programs can be registered.

- 1 Using the touch panel and control panel keys, specify the copy settings to be registered in the copy program.
 - ? Can the current settings be checked?
 - To check the currently specified copy settings, touch [Check Job] in the left panel, and then touch [Job Details]. For details, refer to ["Checking the Copy Settings \(Check Job\)" on page 3-2](#).
- 2 Press the [Mode Memory] key.

The Recall Copy Program screen appears.

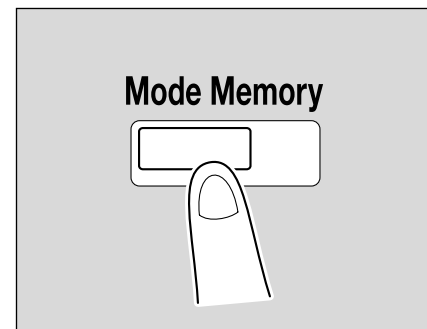

- 3 From the copy program buttons that appear in the screen, touch the button where you wish to store the copy settings, and then touch [Register Program].
 - There are three Recall Copy Program screens. Touch [↑] and [↓] to display a different screen.
 - If 30 copy programs have been registered, delete an unnecessary copy program. For details on deleting copy programs, refer to ["Deleting a copy program" on page 3-10](#).



The Register Copy Program screen appears.

- 4 Use the control panel keypad and the keyboard that appears in the touch panel to type in the name of the copy program.
 - The program name can contain a maximum of 16 characters.

- For details on typing in text, refer to ["Entering text" on page 14-2](#).



- 5 After typing in the name, touch [OK].



- The copy program can be given the same name as a copy program that has already been registered.
- To stop specifying the name of the copy program, touch [Cancel].

The Recall Copy Program screen appears again. The copy program is registered and a button with the entered copy program name appears.



- ? Can the copy program name be corrected?
 - To change the entered copy program name, touch the button whose name is to be changed, and then touch [Edit Name]. The Edit Name screen appears. Return to step 4 and repeat the procedure to change the copy program name.
- ? Can the specified settings for a copy program be checked?
 - To check the programmed copy settings, touch the button for the desired copy program, and then touch [Check Program Settings]. For details, refer to ["Copying with programmed copy settings \(Mode Memory\)" on page 3-11](#).

- 6 Touch [OK] or [Cancel].
 - To return to the Basic screen, press the [Mode Memory] key.



Detail

To stop registering the program, press the [Reset] key or the [Mode Memory] key. No matter which screen is displayed, the registration is cancelled. Otherwise, continue to touch [Cancel] until the Basic screen is displayed.

The settings of a copy program cannot be changed.

If the copy program that was selected has been locked, [Edit Name] and [Delete] do not appear. For details, refer to "System Settings" on page 11-15.

3.4.1 Deleting a copy program

- 1 In the Recall Copy Program screen, touch the button for the copy program to be deleted.
 - If the copy program to be recalled is not displayed, touch [↑] and [↓] until the desired copy program is displayed.
- 2 Touch [Delete].



A message appears, requesting confirmation to delete the copy program.

- 3 Touch [Yes], and then touch [OK].

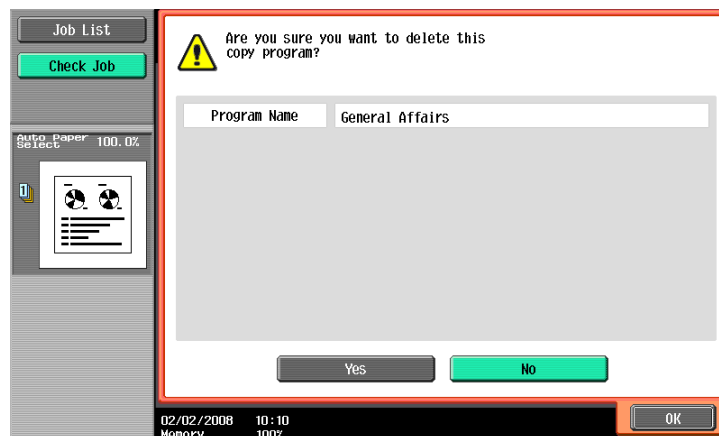

The Recall Copy Program screen appears again. The copy settings registered in the copy program are erased.

3.5 Copying with programmed copy settings (Mode Memory)

Programmed copy settings can be recalled to be used again for copying.

- 1 Position the original to be copied.
 - For details on positioning the original, refer to **"Feeding the original" on page 2-6**.
- 2 Press the [Mode Memory] key.
 - The Recall Copy Program screen appears.

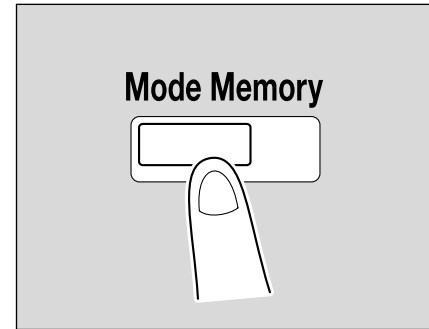

- 3 Touch the button for the copy program registered with the copy settings to be recalled.



- If the copy settings in the selected copy program are not to be checked, continue with step 8.
- If the copy program to be recalled is not displayed, touch [↑] and [↓] until the desired copy program is displayed.

- 4 Press the [Check Program Settings] key.
 - The copy settings cannot be changed from the Check Job Settings screens.



The Check Job Settings screen appears.

There are four Check Job Settings screens. The number to the right of the screen title indicates the number of the currently displayed screen.

To display the previous screen, touch [←Back]. To display the next screen, touch [Forward→].

5 Check the copy settings registered with the selected copy program.

6 Touch [Close].

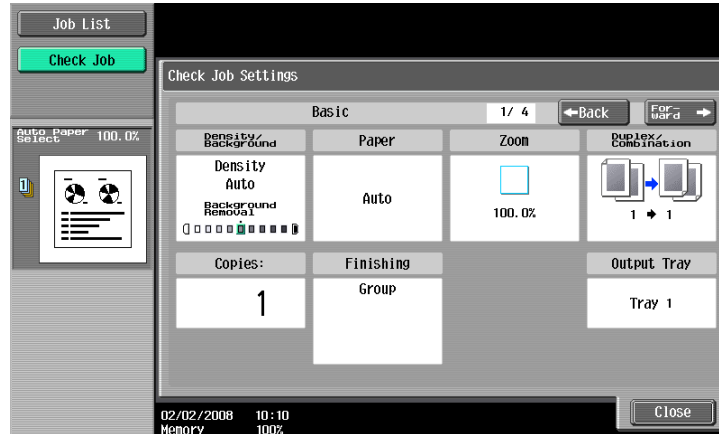

The Recall Copy Program screen appears again.

7 Again touch the button for the copy program registered with the copy settings to be recalled.
 – If [OK] is touched with no copy program selected, the Basic screen appears again without a copy program being recalled.

8 Touch [OK].

The programmed copy settings are recalled and the Basic screen appears again.

9 Press the [Start] key.

Copying begins with the recalled copy settings.



Note

To stop recalling a copy program, press the [Reset] key or the [Mode Memory] key or touch [Cancel].

3.6 Displaying function descriptions (Help)

Descriptions of the various functions and details of operations can be viewed.

There are two methods for displaying the Help screens.

- Main Help screens (from the Basic screen)
- Help screens for settings (from screens other than the Basic screen)

3.6.1 Overview of Help screens

The following items are provided in the Help Menu screen.

Help Menu screen (1st level)

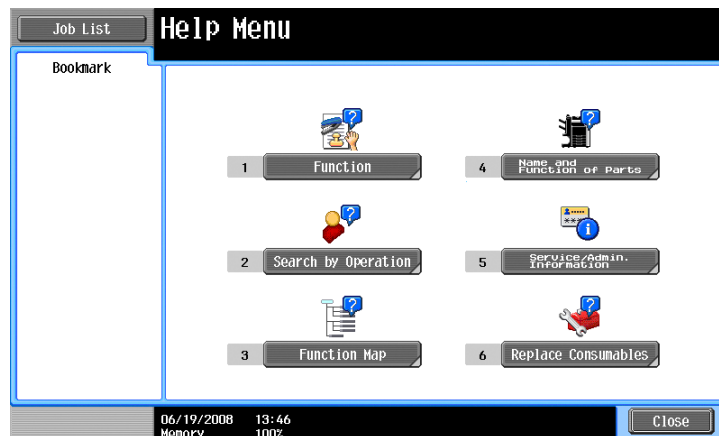

Item	Description
[Function]	Use to search for descriptions from a Help menu divided by the function types and names.
[Search by Operation]	Use to search for descriptions from a Help menu divided by the operations.
[Function Map]	Displays the Function Map screen, which contains a chart of the available functions and settings.
[Name and Function of Parts]	Displays the Help menu for the name and function of each part. Use to check the description of the main unit and its options.
[Service/Admin. Information]	Displays the name, extension number and e-mail address of the administrator.
[Replace Consumables]	Use to view the maintenance procedures for the machine.



Detail

*The Help screens cannot be displayed when the following operations are being performed.
While scanning, while printing a proof copy, during Enlarge Display mode, during Accessibility mode*

*While the Help screens are displayed, the following keys are not available.
[Start], [Stop], [C] (clear), [Interrupt], [Proof Copy], [Access], [Mode Memory], [Enlarge Display]*

Items in the Help Menu screen and other Help screens can be selected by touching the button or by pressing the key in the keypad for the number of the desired item.

To display the next screen higher in the menu structure, touch [Close].

Touch [Exit] to exit the Help mode and return to the screen that was displayed before the [Help] key was pressed.

Help screen (2nd level) (Example: Function)

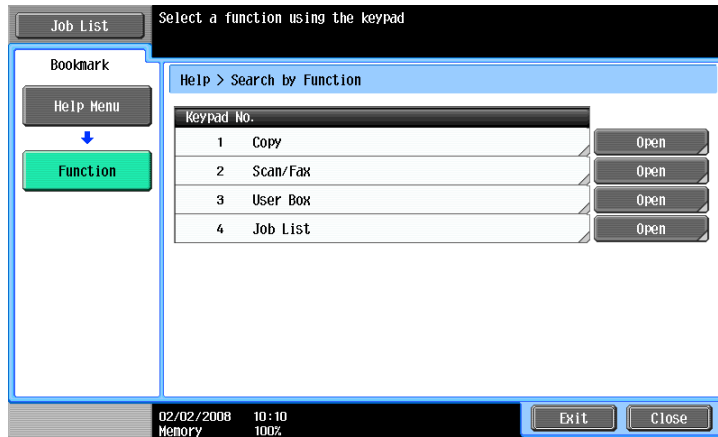

Item	Description
[Copy], [Scan/Fax], [User Box], [Job List]	Displays the first Help screen for each description.



Detail

The items displayed in the Help menu for the name and function of each part differ depending on the options that are installed.

Help screen (bottom level) (Example: Function → Copy → Density/Background → Density)

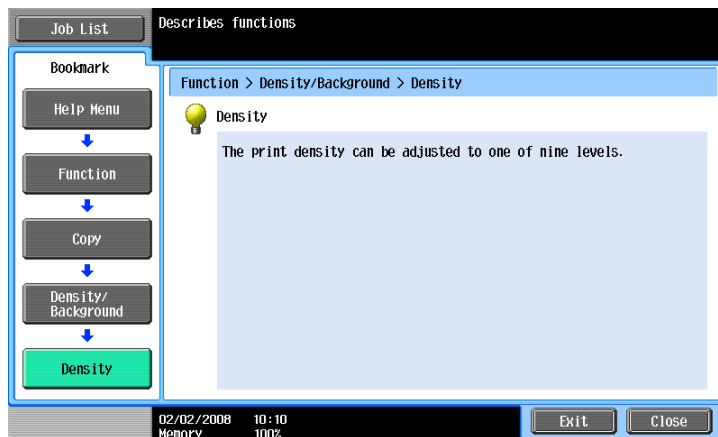

Help screen (bottom level) (Example: Search by Operation → Copying → Copying Special Documents)

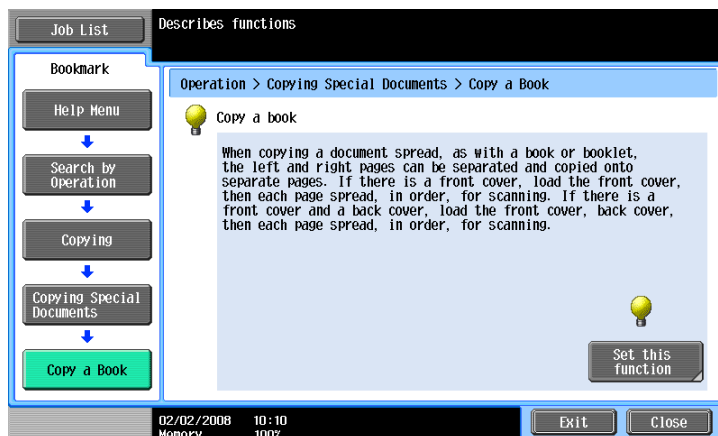

Touch [Set this function] to set the selected function.

Function Map screen (Example: Copy)

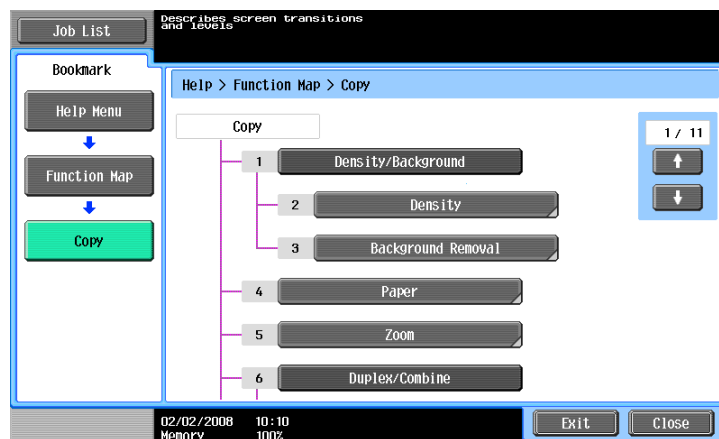

A chart of the available functions and settings are displayed in the function maps. Select an item from the chart for the Help screen that you wish to view.



Detail

There are 11 Function Map screens for Copy mode. The top number indicates the number of the 11 screens that is currently displayed.

To display the previous screen, touch [↑]. To display the next screen, touch [↓].

Press the key in the keypad for the number of the desired item in the Function Map screen.

To display the Help screen for "Function" that contains the selected item, touch [Close] in the Help screen displayed by selecting an item in a Function Map screen.

To quit the Help mode, press the [Help] key or touch [Exit].

3.6.2 Displaying main Help screens

As an example, the following procedures describe the Help screens that are displayed for copy operations by using "Function".

- 1 With the Basic screen displayed, press the [Help] key.
The Help Menu screen appears.

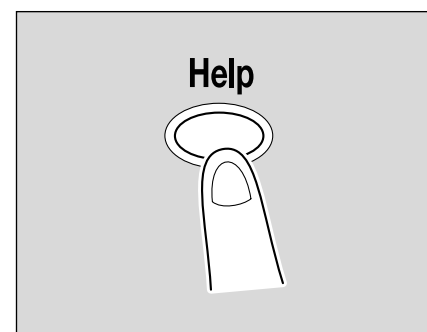

- 2 Touch [Function] or press the [1] key in the keypad.

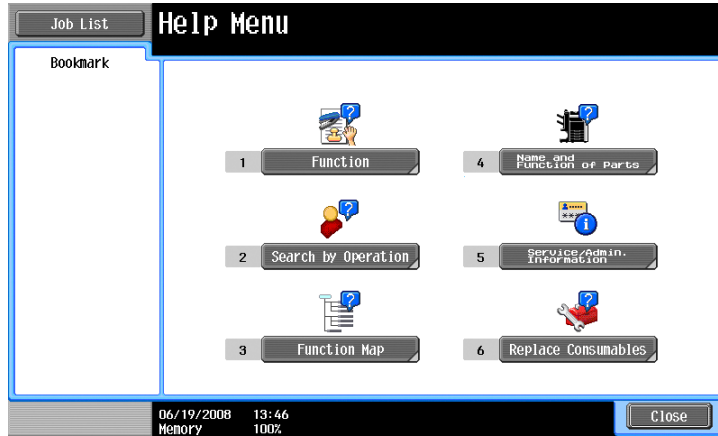

The Help screen for "Function" appears.

? Is there more information about the buttons of the Help screens?

→ Refer to ["Overview of Help screens" on page 3-13.](#)

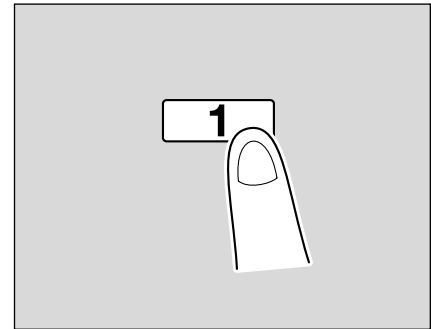

- 3 Touch [Copy] or [Open], or press the [1] key in the keypad.

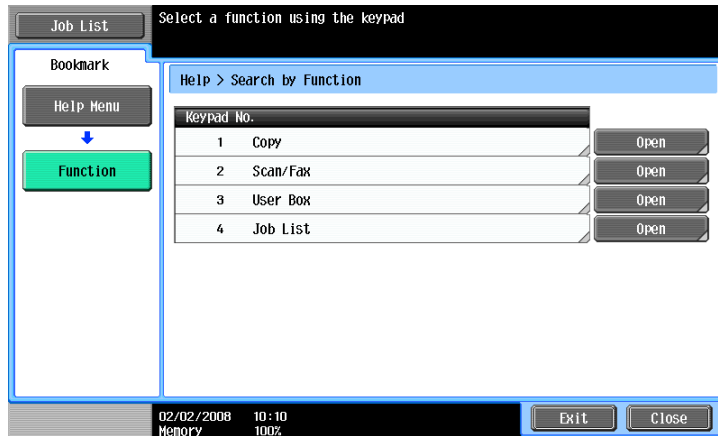

The Copy Help screen appears.

- 4 Touch [Open] or the right of the desired information, or press the key in the keypad for the number to the left of the desired information to display the corresponding Help screen.

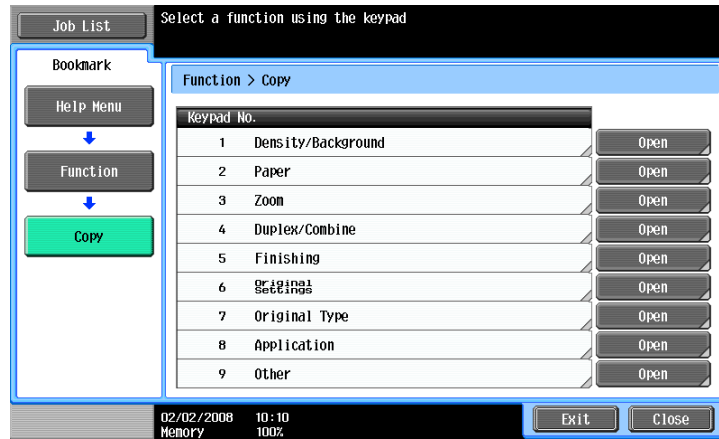

- 5 After checking the Help information, touch [Exit] or press the [Help] key again. The Basic screen appears again.

3.7 Specifying control panel settings (Accessibility mode)

This section contains details on the procedures for specifying control panel settings and adjusting the touch panel.

3.7.1 Displaying the Accessibility Setting screen

- Press the [Accessibility] key.
The Accessibility Setting screen appears.



Detail

To exit the Accessibility Setting screen and return to the Basic screen, press the [Accessibility] key or the [Reset] key, or touch [Close].

When the Enlarge Display mode is selected, the [Default Enlarge Display Setting] button appears to allow specifying the default settings of the copy and fax/scan operations in the Enlarge Display mode.

3.7.2 Setting the "Touch Panel Adjustment" function

If the touch panel buttons do not respond correctly, the position of buttons in the touch panel may not be correctly aligned with the position of the actual touch sensor and may need to be adjusted.

- 1 Display the Accessibility Setting screen.
 - For details on displaying the Accessibility Setting screen, refer to ["Displaying the Accessibility Setting screen" on page 3-18](#).
- 2 Touch [Touch Panel Adjustment] or press the [1] key in the keypad.

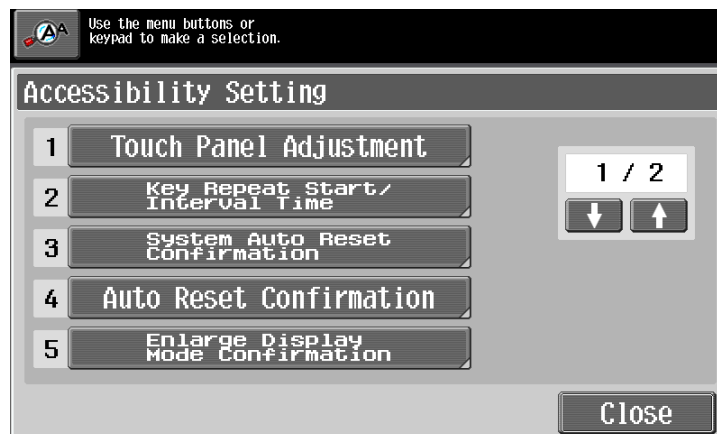

The Touch Panel Adjustment screen appears.

? Why does the machine not respond when [Touch Panel Adjustment.] is touched?

The touch sensors are not aligned on the touch panel.

→ Press the [1] key in the keypad.

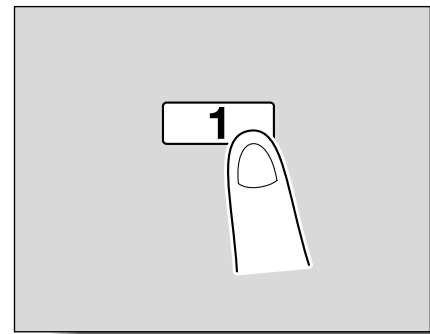

3 Touch the four check points [+], making sure that a sound is produced with each.

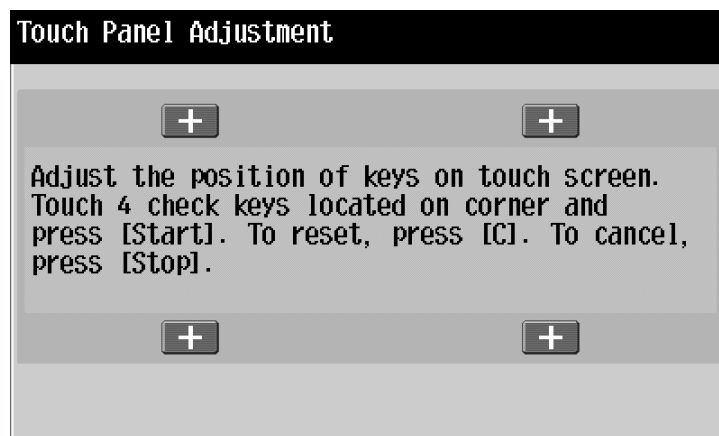

– The check points [+] can be touched in any order.

– To reset the adjustment, press the [C] (clear) key, and then touch the four check points [+].

If the check points have been touched correctly, the indicator on the [Start] key lights up in blue.

4 Press the [Start] key.

The touch panel is adjusted, and the Accessibility Setting screen appears again.

5 Touch [Close] or press the [Accessibility] key.

The Basic screen appears again.



Note

If the touch panel cannot be adjusted, contact the service representative.



Detail

To cancel the touch panel adjustment, press the [Stop] key or the [Reset] key.

3.7.3 Setting the Key Repeat Start/Interval Time functions

The length of time until the value begins to change after a touch panel button is held down and the length of time for the value to change to the next number can be specified.

✓ The settings specified for the Key Repeat Start/Interval Time functions are only applied in the Enlarge Display mode.

1 Display the Accessibility Setting screen.

– For details on displaying the Accessibility Setting screen, refer to "[Displaying the Accessibility Setting screen](#)" on page 3-18.

- 2 Touch [Key Repeat Start/Interval Time] or press the [2] key in the keypad.

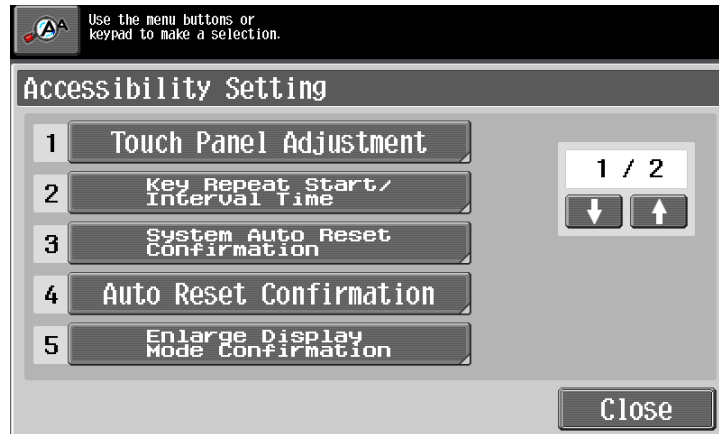

The Key Repeat Start/Interval Time screen appears.

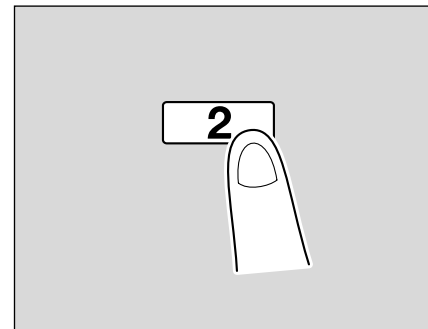

- 3 Touch [+] and [-] to specify the starting time and the interval for the key repeat feature.

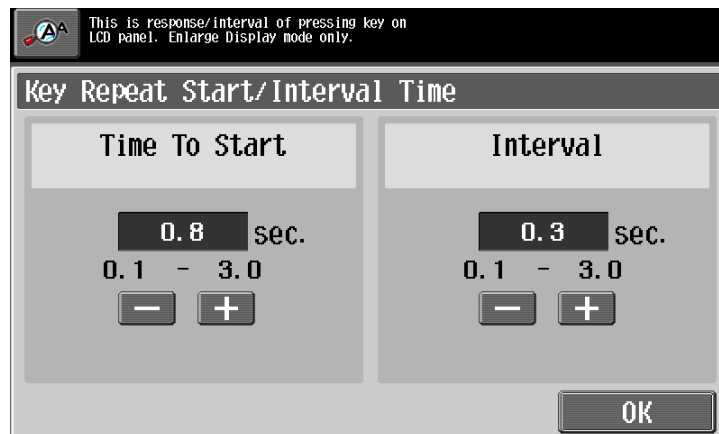

- To extend the time, touch [+].
- To reduce the time, touch [-].
- Both settings can be set between 0.1 and 3.0 seconds in 0.1-second increments.
- To cancel changes to the settings, press the [Reset] key.

- 4 Touch [OK].
The Accessibility Setting screen appears again.
- 5 Touch [Close] or press the [Accessibility] key.
The Basic screen appears again.

**Note**

The Enlarge Display mode is compatible with basic copy, scanning and fax functions. With the Enlarge Display mode, text and illustrations are displayed at a larger size so that they can be seen more easily. For details, refer to the User's Guide [Enlarge Display Operations].

As the factory default, "Time To Start" is set to 0.8 second and "Interval" is set to 0.3 second.

3.7.4 Setting the "System Auto Reset Confirmation" function

When the system auto reset operation is performed in Enlarge Display mode, a message can be displayed, allowing you to choose either to continue operating without exiting Enlarge Display mode or to exit Enlarge Display mode and return to the Basic screen.

In addition, it is possible to specify the display time for the message requesting confirmation to exit Enlarge Display mode.

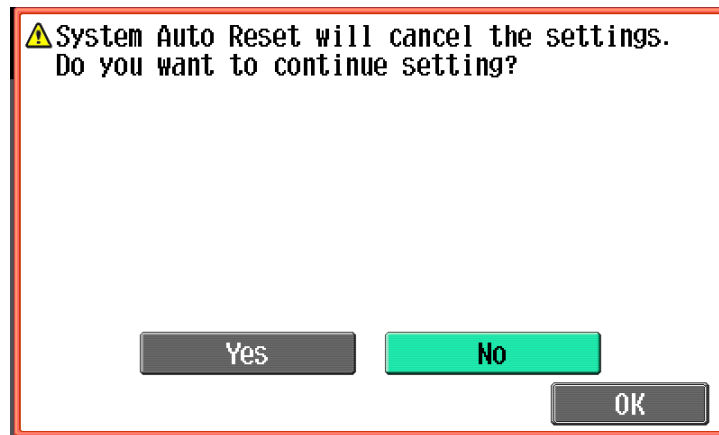

Yes: Enlarge Display mode is not exited.

No: Enlarge Display mode is exited, and the Basic screen is displayed.

- 1 Display the Accessibility Setting screen.
 - For details on displaying the Accessibility Setting screen, refer to ["Displaying the Accessibility Setting screen" on page 3-18](#).

For details on the automatic system reset operation, refer to ["Automatically conserving energy \(Sleep mode\)" on page 1-33](#).

- 2 Touch [System Auto Reset Confirmation] or press the [3] key in the keypad.

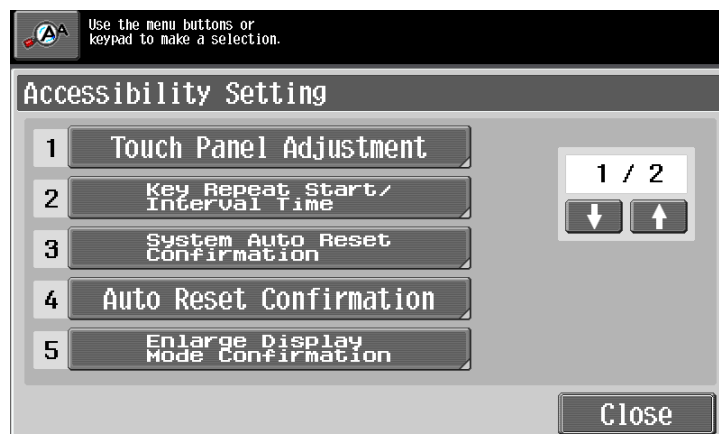

The System Auto Reset Confirmation screen appears.

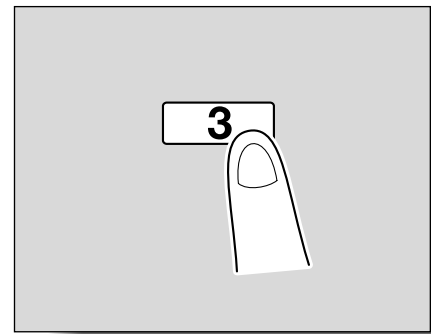

- 3 Touch the button for the desired display time.

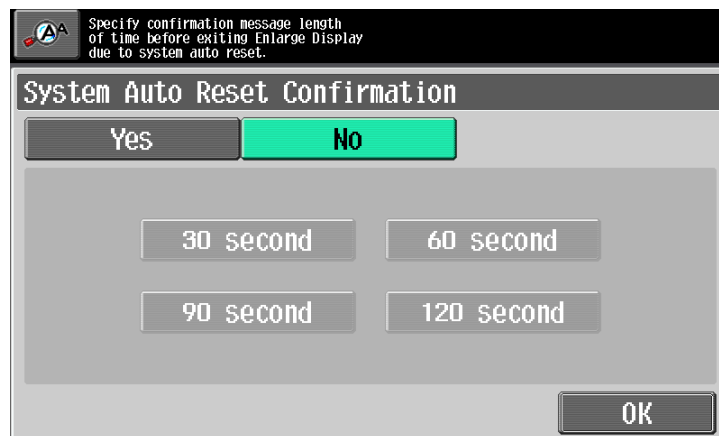

- To not display the message requesting confirmation to exit Enlarge Display mode, touch [No].
- To display the message requesting confirmation to exit Enlarge Display mode, touch the button ([30 second], [60 second], [90 second] or [120 second]) for the length of time that the message is to be displayed.
- To cancel changes to the settings, press the [Reset] key. All changes to the settings are canceled.

- 4 Touch [OK].

The Accessibility Setting screen appears again.

- 5 Touch [Close] or press the [Accessibility] key.

The Basic screen appears again.



Note

The Enlarge Display mode is compatible with basic copy, scanning and fax functions. With the Enlarge Display mode, text and illustrations are displayed at a larger size so that they can be seen more easily. For details, refer to the User's Guide [Enlarge Display Operations].

As the factory default, "No" is selected.

3.7.5 Setting the "Auto Reset Confirmation" function

When the automatic panel reset operation is performed in Enlarge Display mode, a message can be displayed, allowing you to choose either to continue operating without resetting the current settings or to reset the settings.

In addition, it is possible to specify when the message is displayed, requesting confirmation to reset the settings in Enlarge Display mode.

As the factory default, "No" is selected.

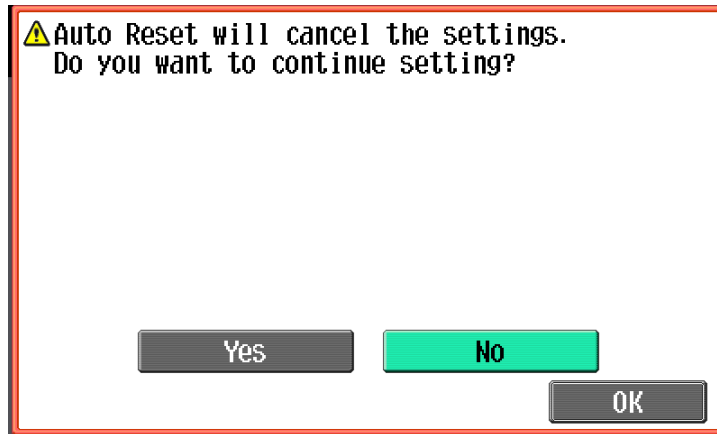

Yes: The current settings are not reset.

No: The current settings are reset to the default settings.



Note

For details on the automatic panel reset operation, refer to ["Automatically clearing settings \(automatic panel reset\)" on page 1-31.](#)

- 1 Display the Accessibility Setting screen.
 - For details on displaying the Accessibility Setting screen, refer to ["Displaying the Accessibility Setting screen" on page 3-18.](#)
- 2 Touch [Auto Reset Confirmation] or press the [4] key in the keypad.

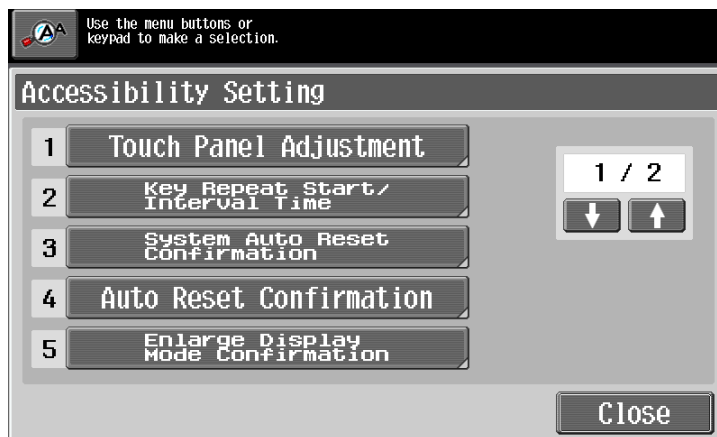

The Auto Reset Confirmation screen appears.

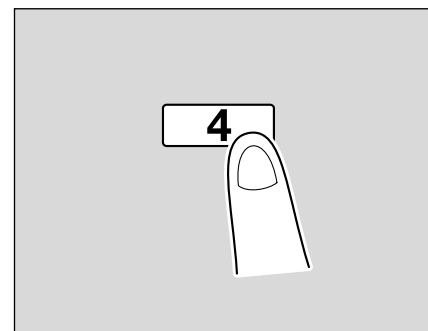

- 3 Touch the button for the desired display time.



- To not display the message requesting confirmation to reset the settings, touch [No].
- To display the message requesting confirmation to reset the settings, touch the button ([30 second], [60 second], [90 second] or [120 second]) for the length of time that the message is to be displayed.
- To cancel changes to the settings, press the [Reset] key. All changes to the settings are canceled.

- 4 Touch [OK].
The Accessibility Setting screen appears again.

- 5 Touch [Close] or press the [Accessibility] key.
The Basic screen appears again.



Note

The Enlarge Display mode is compatible with basic copy, scanning and fax functions. With the Enlarge Display mode, text and illustrations are displayed at a larger size so that they can be seen more easily. For details on the Enlarge Display mode, refer to the User's Guide [Enlarge Display Operations].

If the time setting is the same for the automatic panel reset operation and the automatic system reset operation, the display of the message requesting confirmation to exit Enlarge Display mode is given priority and the message requesting confirmation to reset the settings in Enlarge Display mode is not displayed.

3.7.6 Setting the "Enlarge Display Mode Confirmation" function

When the [Enlarge Display] key is pressed to change the display of the screen, a message can be displayed, requesting confirmation to cancel the settings that cannot be specified in Enlarge Display mode.

As the factory default, "OFF" is selected.

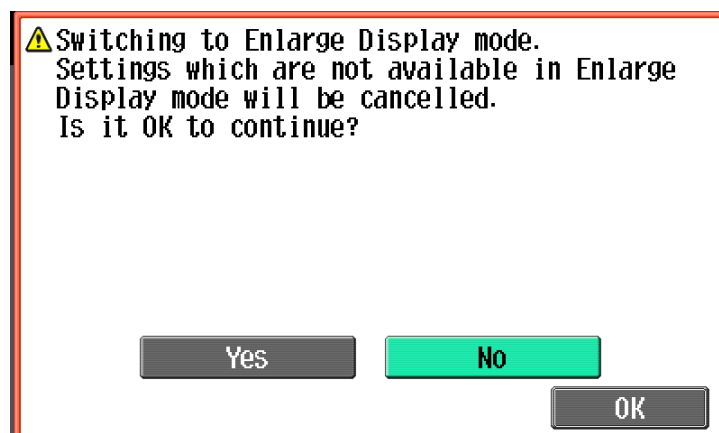

Yes: The settings that cannot be displayed are cancelled, and the Enlarge Display mode is entered.

No: The Enlarge Display mode is not entered.

- 1 Display the Accessibility Setting screen.
 - For details on displaying the Accessibility Setting screen, refer to "[Displaying the Accessibility Setting screen](#)" on page 3-18.
- 2 Touch [Enlarge Display Mode Confirmation] or press the [5] key in the keypad.

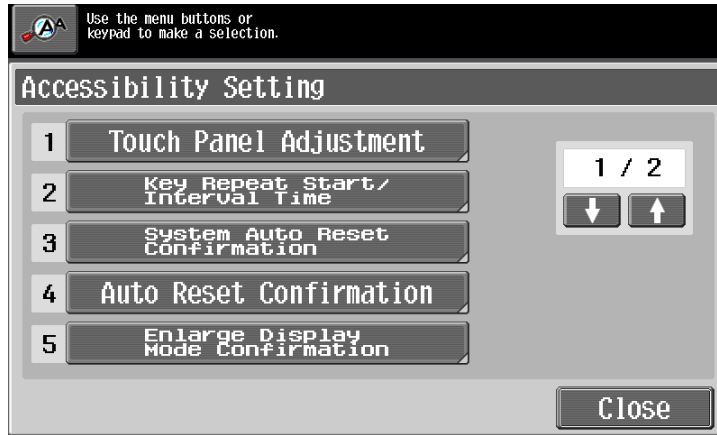

The Enlarge Display Mode Confirmation screen appears

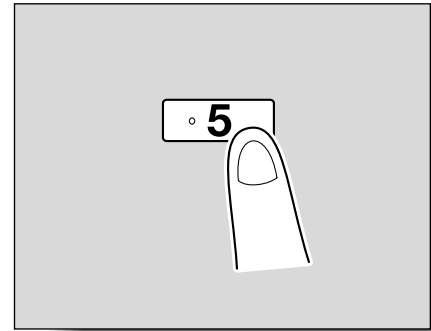

- 3 Select whether or not the message is displayed.

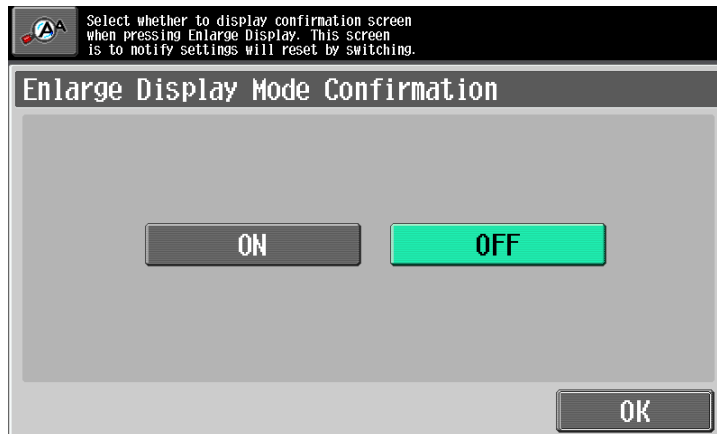

- To cancel changes to the settings, press the [Reset] key. All changes to the settings are canceled.

- 4 Touch [OK].
The Accessibility Setting screen appears again.
- 5 Touch [Close] or press the [Accessibility] key.
The Basic screen appears again.

**Note**

The *Enlarge Display mode* is compatible with basic copy, scanning and fax functions. With the *Enlarge Display mode*, text and illustrations are displayed at a larger size so that they can be seen more easily. For details on the *Enlarge Display mode*, refer to the User's Guide [Enlarge Display Operations].

If "OFF" is selected in the *Enlarge Display Mode Confirmation* screen, the screen is not displayed.

3.7.7 Setting the "Message Display Time" function

It is possible to specify the length of time for displaying warning messages, which appear, for example, when an incorrect operation is performed.

As the factory default, "3 seconds" is selected.

- 1 Display the Accessibility Setting screen, and then touch [↓] to display the next screen.
 - For details on displaying the Accessibility Setting screen, refer to ["Displaying the Accessibility Setting screen" on page 3-18](#).
- 2 Touch [Message Display Time] or press the [1] key in the keypad.



The Message Display Time screen appears.

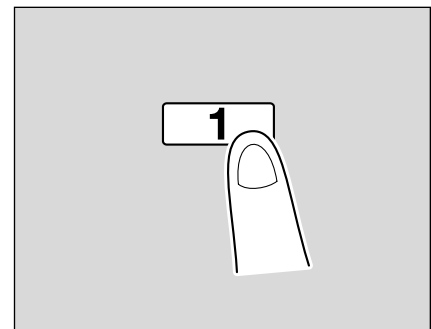

- 3 Select setting for the desired amount of time that messages are displayed.
 - Touch [3 seconds] or [5 seconds] to select how long messages are displayed.

- To cancel changes to the settings, press the [Reset] key. All changes to the settings are canceled.

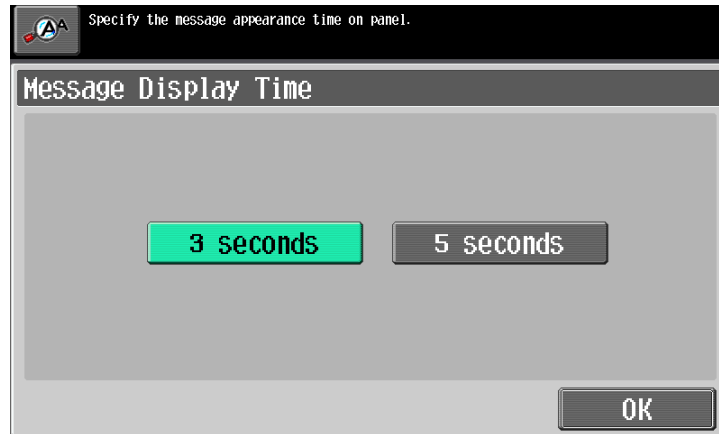

- 4 Touch [OK].
The Accessibility Setting screen appears again.
- 5 Touch [Close] or press the [Accessibility] key.
The Basic screen appears again.

3.7.8 Setting the "Sound Setting" functions

With the Sound Setting functions, The sound level can be adjusted by selecting on from 16 levels provided for the sounds that are produced, for example, when a key is pressed. Specified sound can also be muted in this setting.

For details, see the table below.

As the factory default, "8" is selected for all operation sounds.

		Operation Confirmation Sound
Sound ON/OFF Settings	All Sounds	Select to turn on/off all sounds in Sound Setting.
	Operation Confirmation Sound	Select to turn on/off all sounds in Operation Confirmation Sound setting.
	Successful Completion Sound	Select to turn on/off all sounds in Successful Completion Sound setting.
	Completed Preparation Sound	Select to turn on/off the Completed Preparation Sound setting.
	Caution Sound	Select to turn on/off all sounds in Caution Sound setting.
Operation Confirmation Sound	Input Confirmation Sound	When pressing a key in the control panel or a button on the touch panel
	Invalid Input Sound	When incorrectly pressing a key in the control panel or a button on the touch panel
	Basic Sound	When switching settings and the default setting is selected
Successful Completion Sound	Completed Operation Sound	When an operation is completed successfully
	Completed Transmission Sound	When a communication operation is completed successfully
Completed Preparation Sound		When a device has finished setting up
Caution Sound	Simple Caution Sound (Level 1)	When it is almost time to replace supplies or a replaceable part and a message appears in the touch panel
	Simple Caution Sound (Level 2)	When a user has performed an operation incorrectly
	Simple Caution Sound (Level 3)	When an error occurs that can be corrected by the user by referring to the message that appeared or the User's Guide
	Severe Caution Sound	When an error occurs that cannot be corrected by the user or requires a service representative

- 1 Display the Accessibility Setting screen, and then touch [↓] to display the next screen.
 - For details on displaying the Accessibility Setting screen, refer to "[Displaying the Accessibility Setting screen](#)" on page 3-18.
- 2 Touch [Sound Setting] or press the [2] key in the keypad.

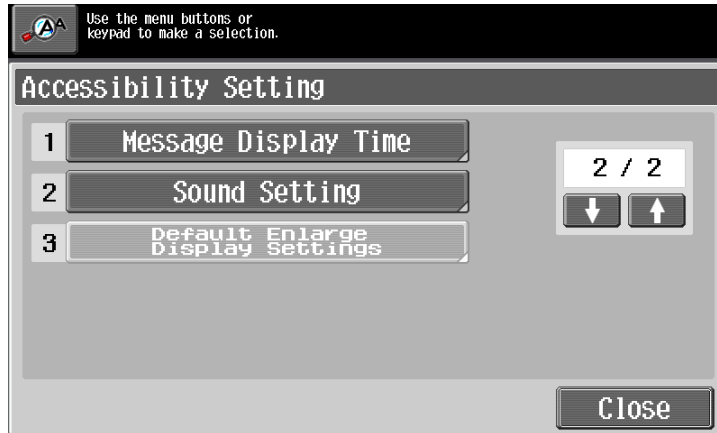

The Sound Setting screen appears.

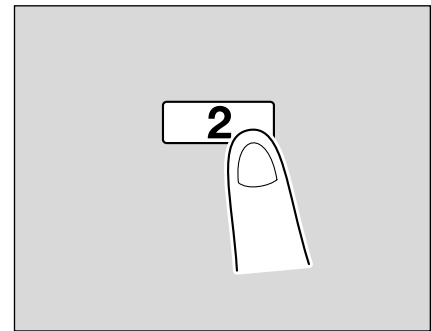

- 3 Touch the button or press the key in the keypad for the desired sound setting (2-5).
 - Sound settings 2 through 5 are available only if the corresponding sound setting on the Sound ON/OFF Settings screen is set to "ON".



The screen for selected sound setting appears.

- 4 Touch the button or press the key in the keypad for the desired sound setting.

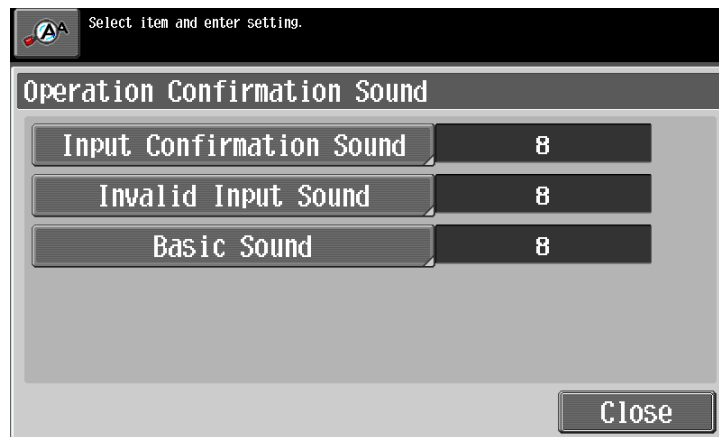

The screen for adjusting sound level appears.

- 5 Adjust the sound level.

- To produce the sound, touch [Yes]. The sound level can be selected from 16 levels. Every touching [Lower]/[Higher] increases/decreases a single level. To mute the sound, touch [No].

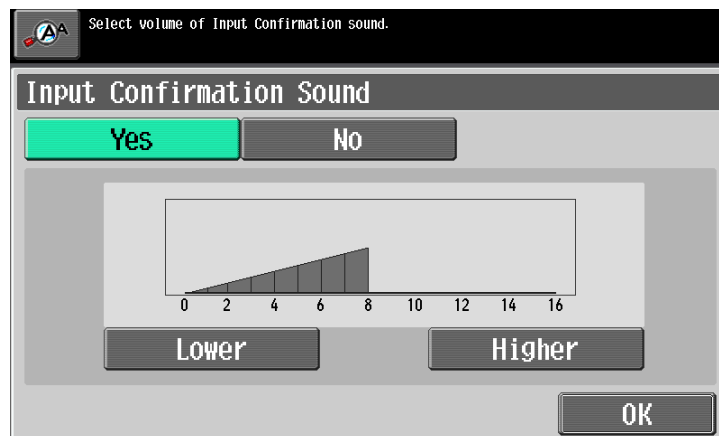

- To cancel changes to the settings, press the [Reset] key. All changes to the settings are canceled.

- 6 Touch [OK], then touch [Close].

The Sound Setting screen appears again.

- 7 To enable/disable the sound setting collectively from 2 to 5, touch [Sound ON/OFF Settings] or press the [1] key in the keypad.

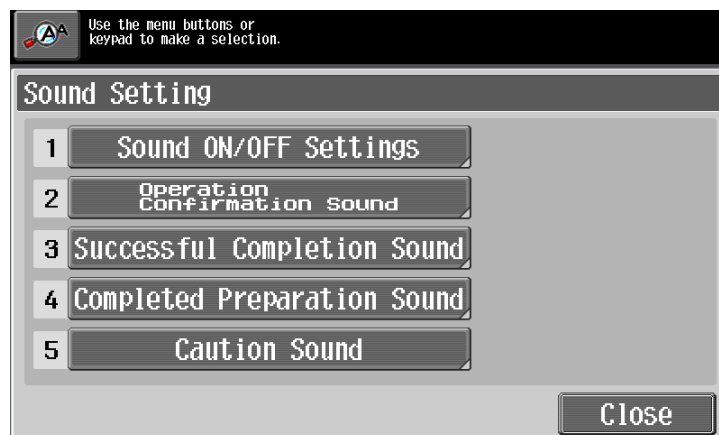

The Sound ON/OFF Settings screen appears.

- 8 Select [On] or [No] for the desired setting item.



- 9 Touch [OK].
The sound Setting screen appears again.
- 10 Touch [Close].
The Accessibility Setting screen appears again.
- 11 Touch [Close] or press the [Accessibility] key.
The Basic screen appears again.

4 Troubleshooting

4 Troubleshooting

4.1 When an error code appears

There are three types of errors; errors that can be cleared by opening and closing the front door, errors that can be cleared by turning the power off/on, and errors that cannot be cleared. Clear the error by following the on-screen instructions. If the error cannot be cleared or released, contact your service representative with the error code.

The phone number and fax number for the usual service representative appear in the center of the screen.

Example: Error that can be cleared by turning the power off/on (C-E002)

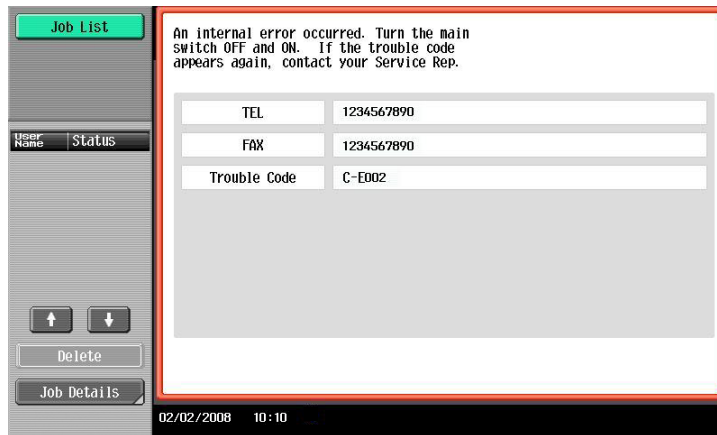

Display in Enlarge Display mode

If the internal error occurs, the screen shown below appears.

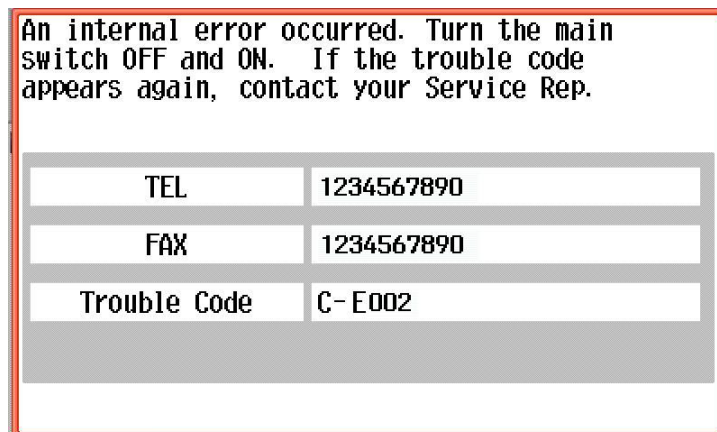

Reminder

Since the machine may be damaged, contact the service representative according to the procedure described below as soon as the call service representative screen appears.

- 1 Write down the trouble code (for example, C-E0002) in the call service representative screen.
- 2 Turn the machine off by using the [Power] (auxiliary power) key and the main power switch.

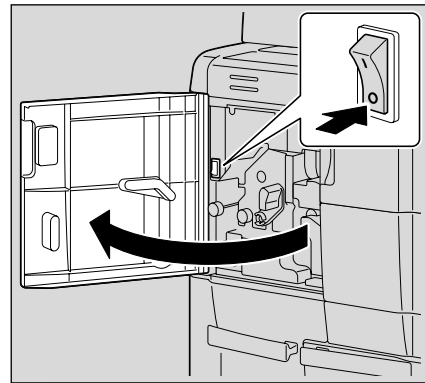
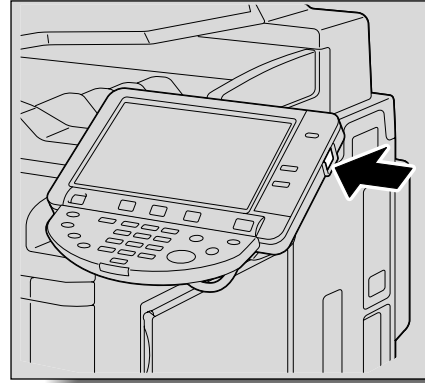

- 3 Unplug the machine.
- 4 Contact the service representative, and inform them of the trouble code.

4.2 When the message "misfeed detected." appears

If a misfeed occurs during printing, the message "A paper misfeed has been detected. Remove the paper according to the guide or illustration." appears, and the location of the misfeed is indicated by a number accompanied with the procedure for clearing misfed paper on the screen.

At this time, printing cannot continue until the misfeed is adequately cleared.

Misfeed Location screen

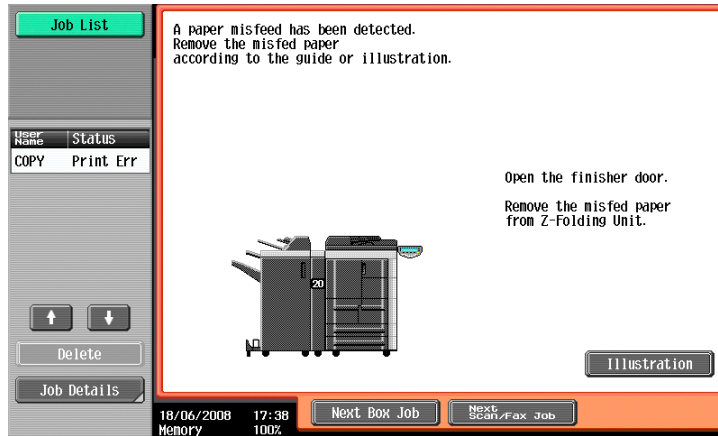

4.2.1 Location of paper misfeed and illustration

If paper misfeeds have occurred at multiple locations, multiple numbers appear or flash. The flashing number indicates the location where the paper misfeed should be cleared first.



Touching the [Illustration] key on the Misfeed Location screen displays another screen with the message "Remove the misfed paper according to the guide or illustration.", and also with a description and illustration for clearing misfed paper.

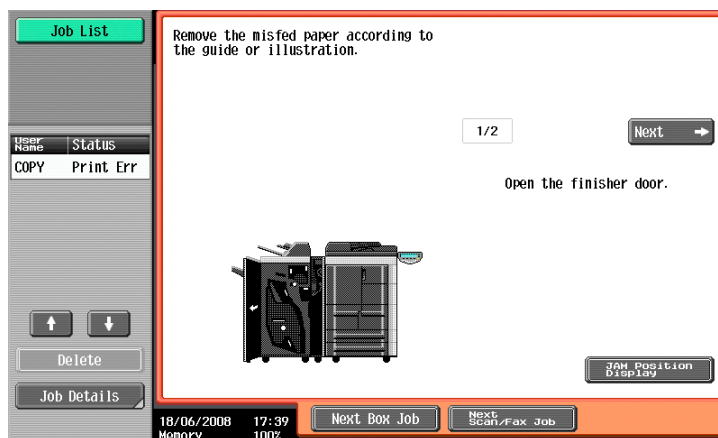

If the description extends over multiple pages, the [Next→] key is displayed. Touch [Next] to proceed to the next screen.

Touching [JAM Location Display] returns to the Misfeed Location screen.

4.2.2 Paper misfeed indications

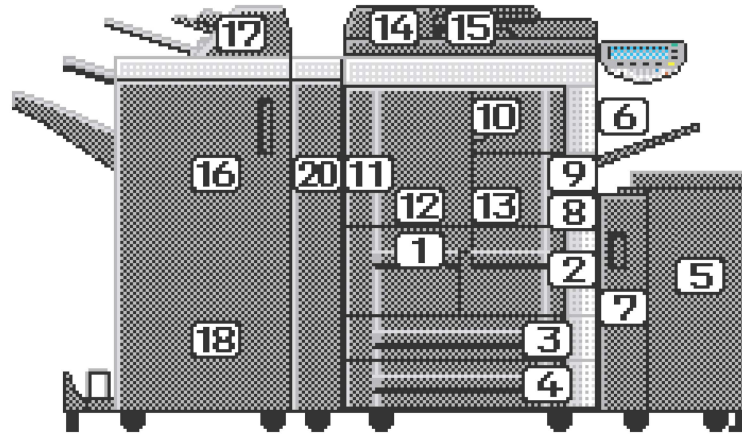

*The illustration above shows the main unit with the optional Finisher FS-610, Z folding unit, post inserter and Large Capacity Unit LU-405 installed.

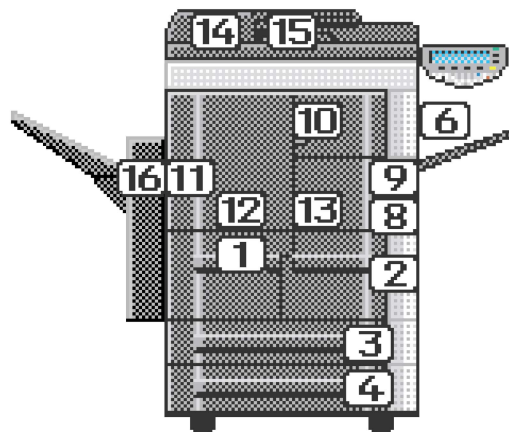

*The illustration above shows the main unit with the optional shift tray installed.

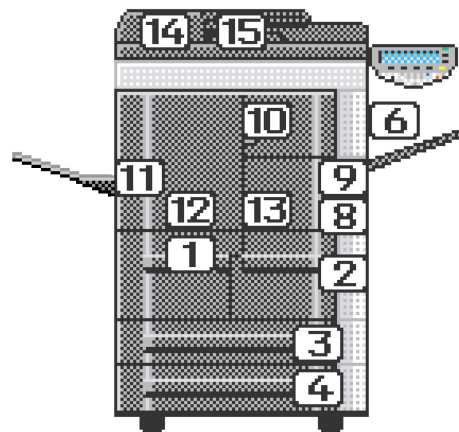

*The illustration above shows the main unit with the optional output tray installed.

No.	Description
1	Paper misfeed in tray 1
2	Paper misfeed in tray 2
3	Paper misfeed in tray 3
4	Paper misfeed in tray 4
5	Paper misfeed in the LCT (Large Capacity Unit LU-405/LU-406)
6	Paper misfeed in the bypass tray
7	Paper misfeed in the vertical transport section
8	Paper misfeed in the ADU unit
9	Paper misfeed in the ADU unit
10	Paper misfeed in the ADU unit
11	Paper misfeed in the ADU unit
12	Paper misfeed in the ADU unit
13	Paper misfeed in the ADU unit
14	Paper misfeed in the ADF
15	Paper misfeed in the ADF
16	Paper misfeed in Finisher FS-524/FS-525/FS-610 or shift tray
17	Paper misfeed in the post inserter
18	Paper misfeed in Finisher FS-524/FS-525/FS-610
20	Paper misfeed in the Z folding unit

4.2.3 Cleaning a paper misfeed in tray 1 "1"



Note

For details of the locations of paper misfeeds, refer to *"Paper misfeed indications"* on page 4-5.

- 1 Pull out tray 1.
 - If the misfed paper extends over tray 1 and tray 2, also pull out tray 2.

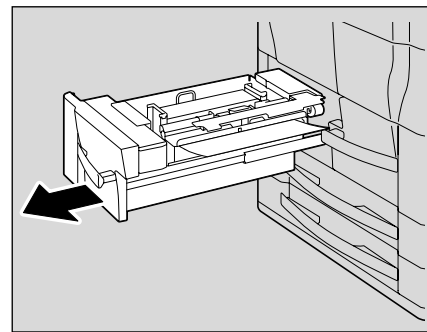

- 2 Remove any misfed paper.

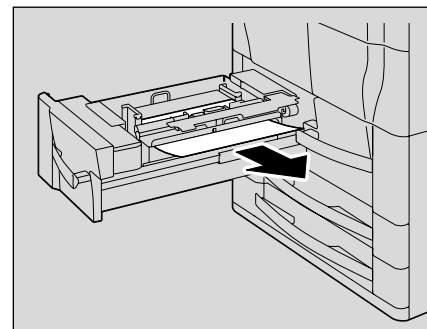

- 3 Lift up the paper take-up roller, and then remove any paper remaining in the tray.

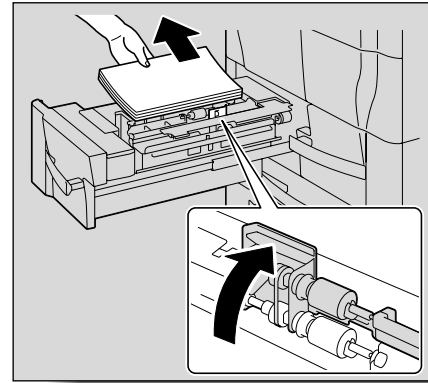

- 4 Load the paper into the tray again, lower the paper take-up roller, and then close the tray.

- 5 Pull out tray 2, and then pull out the horizontal transport unit.

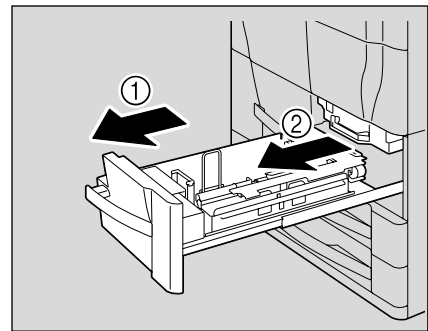

- 6 Open the horizontal transport unit cover.

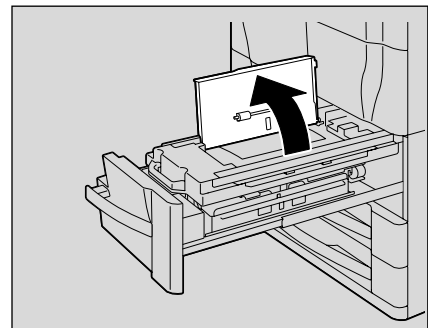

- 7 Remove any misfed paper in the horizontal transport unit.

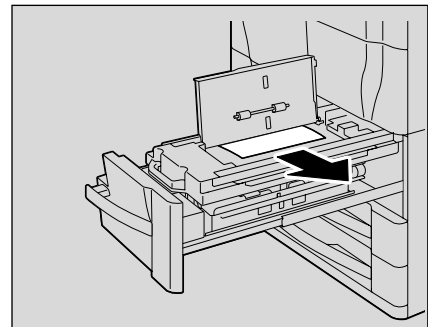

- 8 Return the horizontal transport unit and tray 2 to their original positions.

- 9** Open the vertical transport door.
- If a large capacity unit is installed, open its large capacity tray front door, and then open the vertical transport door.

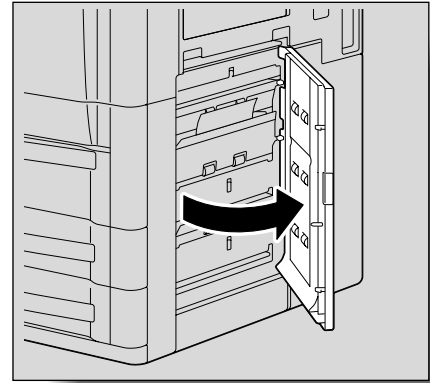

- 10** Remove any misfed paper in the vertical transport section.

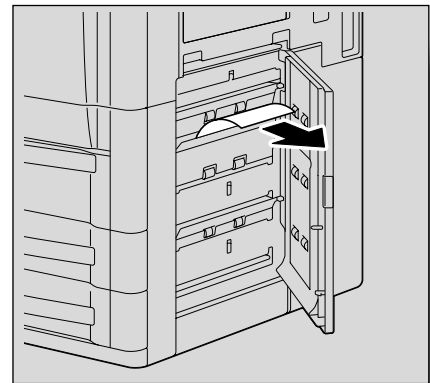

- 11** Close the vertical transport door.

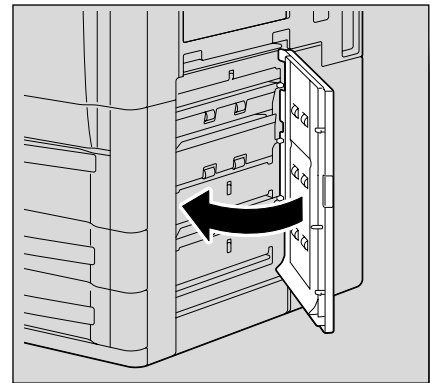

4.2.4 Cleaning a paper misfeed in tray 2 "2"



Note

For details of the locations of paper misfeeds, refer to *"Paper misfeed indications"* on page 4-5.

- 1 Pull out tray 2.

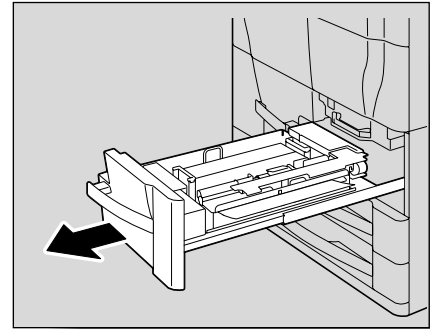

- 2 Remove any misfed paper.

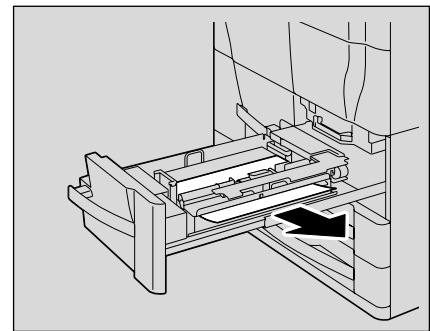

- 3 Lift up the paper take-up roller, and then remove any paper remaining in the tray.

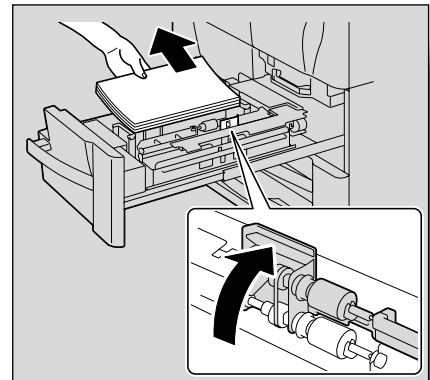

- 4 Load the paper into the tray again, lower the paper take-up roller, and then close the tray.

- 5 Open the vertical transport door.
 - If a large capacity unit is installed, open its large capacity tray front door, and then open the vertical transport door.

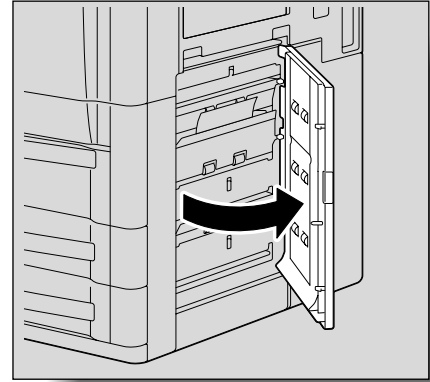

- 6 Remove any misfed paper in the vertical transport section.

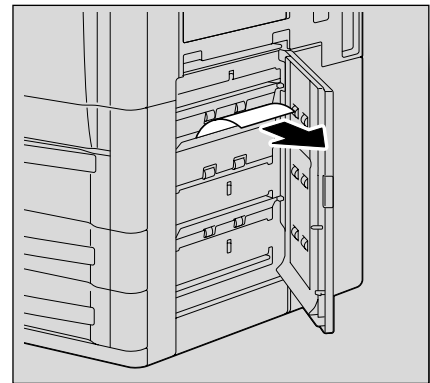

- 7 Close the vertical transport door.

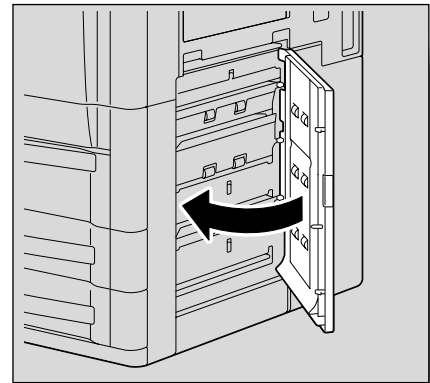

4.2.5 Cleaning a paper misfeed in tray 3 and tray 4 "3"4"



Note

For details of the locations of paper misfeeds, refer to *"Paper misfeed indications"* on page 4-5.

- 1 Pull out tray 3 or tray 4.

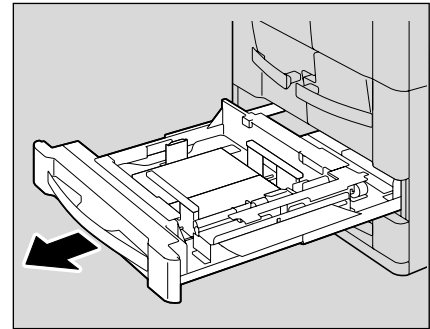

- 2 Remove any misfed paper.

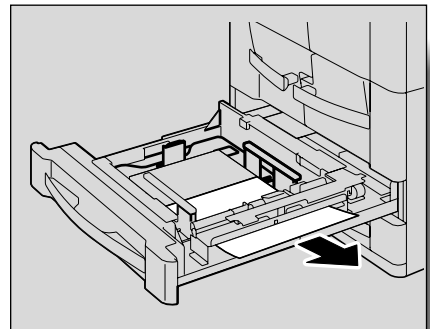

- 3 Lift up the paper take-up roller, and then remove any paper remaining in the tray.

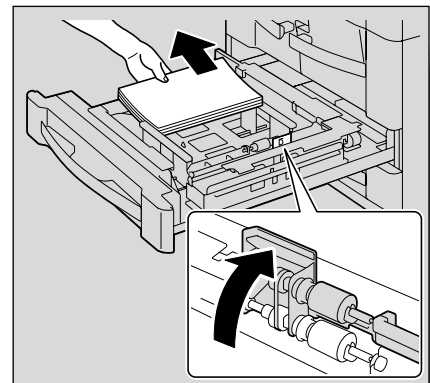

- 4 Load the paper into the tray again, lower the paper take-up roller, and then close the tray.

- 5 Open the vertical transport door.
 - If a large capacity unit is installed, open its large capacity tray front door, and then open the vertical transport door.

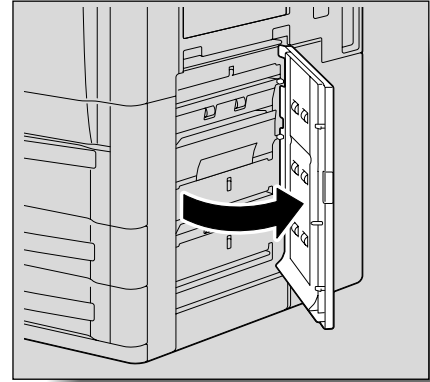

- 6 Remove any misfed paper in the vertical transport section.

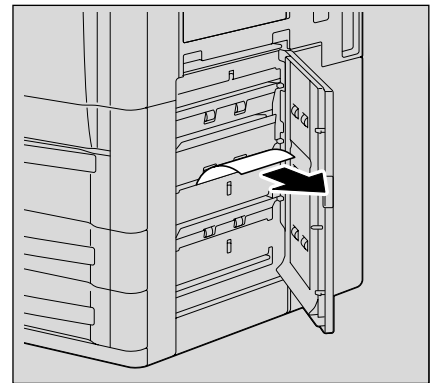

- 7 Close the vertical transport door.

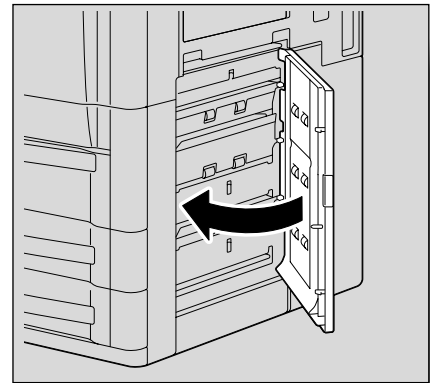

4.2.6 Cleaning a paper misfeed in the LCT (Large Capacity Unit)"5"



Note

For details of the locations of paper misfeeds, refer to *"Paper misfeed indications"* on page 4-5.

- 1 Open the large capacity tray front door.

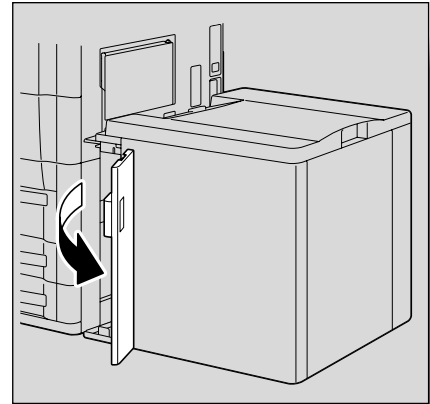

- 2 Remove any misfed paper.

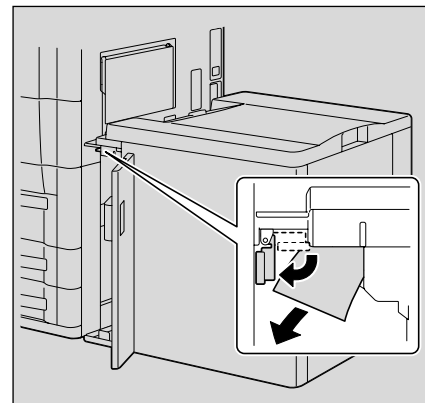

- 3 Open the upper cover.

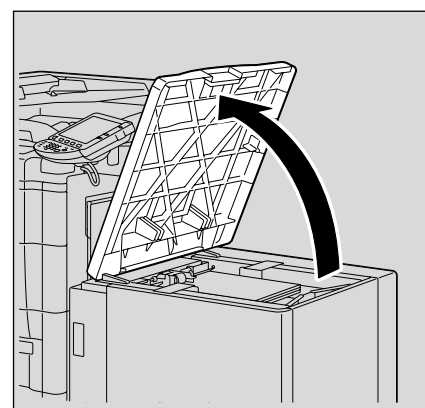

- 4 Lift up the paper take-up roller, and then remove any paper remaining in the tray.

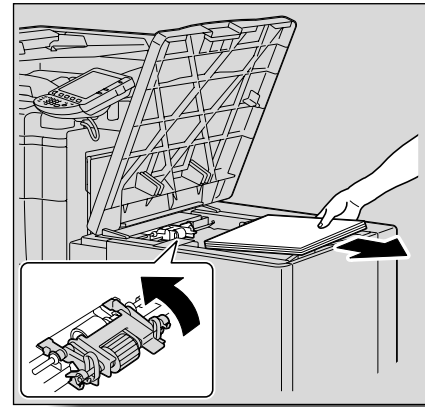

- 5 Load the paper into the tray again, lower the paper take-up roller, and then close the upper cover.

4.2.7 Cleaning a paper misfeed in the bypass tray "6"



Note

For details of the locations of paper misfeeds, refer to "Paper misfeed indications" on page 4-5.

- 1 Remove all paper from the bypass tray.

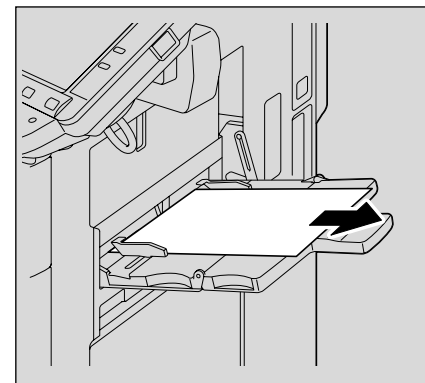

- 2 Load the paper into the tray again.

4.2.8 Cleaning a paper misfeed in the vertical transport section "7"



Note

For details of the locations of paper misfeeds, refer to *"Paper misfeed indications"* on page 4-5.

- 1 Open the vertical transport door.
 - If a large capacity unit is installed, open its large capacity tray front door, and then open the vertical transport door.

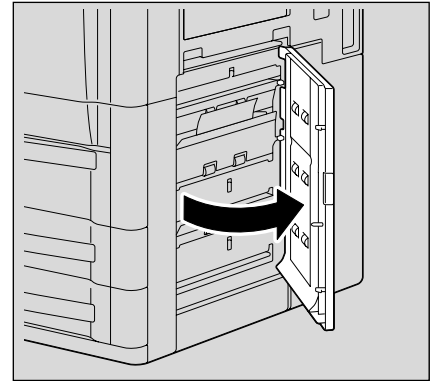

- 2 Remove any misfed paper in the vertical transport section.

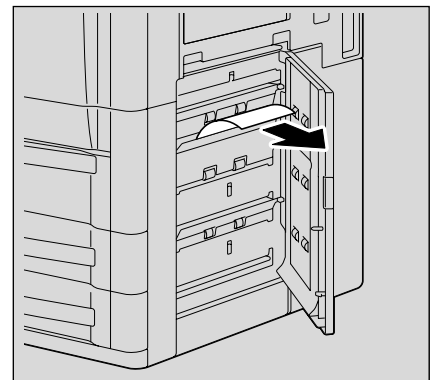

- 3 Close the vertical transport door.

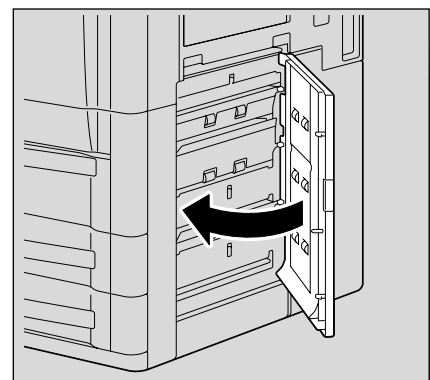

4.2.9 Cleaning a paper misfeed in the ADU unit "8"



Note

For details of the locations of paper misfeeds, refer to *"Paper misfeed indications"* on page 4-5.

- 1 Open the right front door and the left front door.

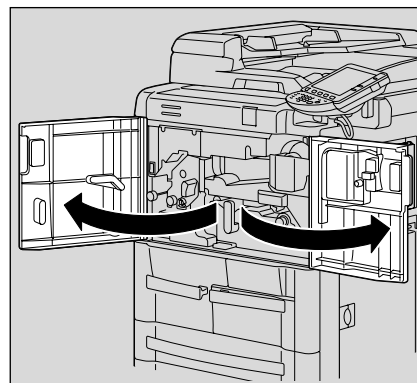

- 2 Turn dial M2 to feed out the paper.

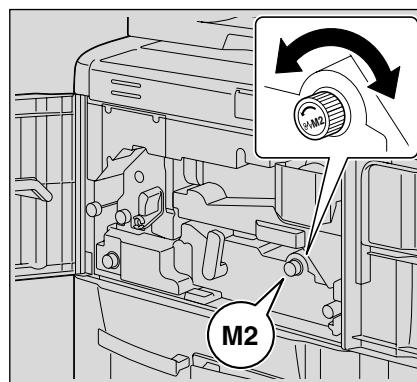

- 3 Lower lever M4, and then pull out the ADU unit.

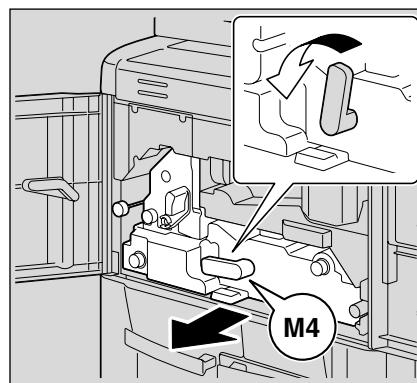

- 4 Raise lever M3, and then remove any paper.

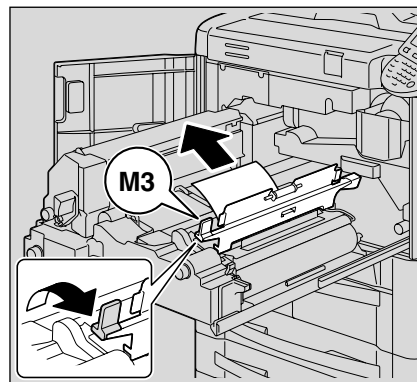

- 5 Return the ADU unit to its original position.
- 6 Return lever M4 to its original position, and then close the right front door and the left front door.

⚠ WARNING

Precaution for electrical shock

High voltage is generated around the drum unit inside the machine.

- In order to reduce the risk of electric shock, do not touch any part in this unit when clearing paper misfeeds.

⚠ CAUTION

Precaution for high temperature

The fusing unit inside the machine is extremely hot.

- In order to reduce the risk of burns, do not touch any part in this unit when clearing paper misfeeds.

4.2.10 Cleaning a paper misfeed in the ADU unit "9"



Note

For details of the locations of paper misfeeds, refer to *"Paper misfeed indications"* on page 4-5.

- 1 Open the right front door and the left front door.

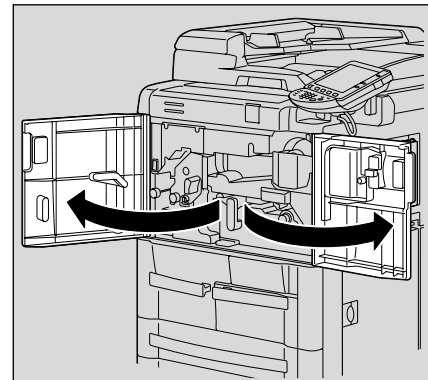

- 2 Turn dial M1 and M2 to feed out the paper.

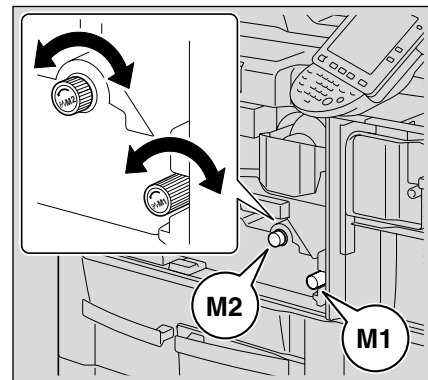

- 3 Lower lever M4, and then pull out the ADU unit.

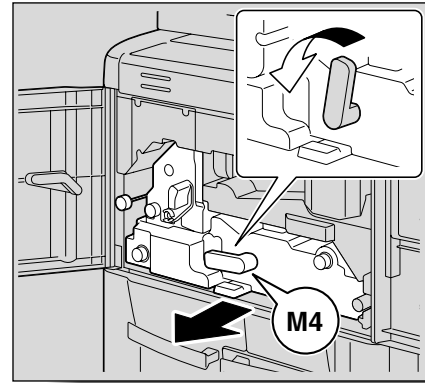

- 4 Raise cover M12, and then remove any paper.

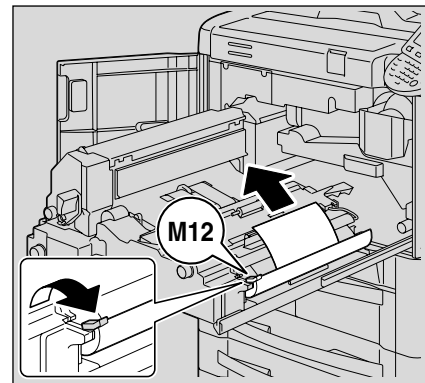

- 5 Raise cover M3, and then remove any paper.

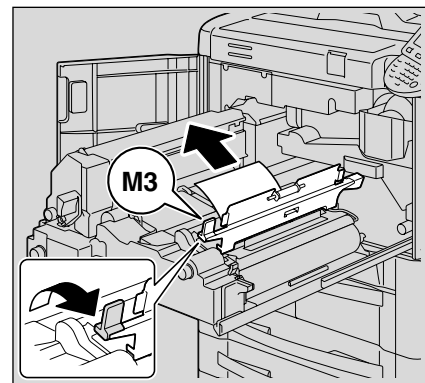

- 6 Return the ADU unit to its original position.

- 7 Return lever M4 to its original position, and then close the right front door and the left front door.

⚠ WARNING

Precaution for electrical shock

High voltage is generated around the drum unit inside the machine.

- In order to reduce the risk of electric shock, do not touch any part in this unit when clearing paper misfeeds.

⚠ CAUTION

Precaution for high temperature

The fusing unit inside the machine is extremely hot.

→ In order to reduce the risk of burns, do not touch any part in this unit when clearing paper misfeeds.

4.2.11 Cleaning a paper misfeed in the ADU unit "10"



...

Note

For details of the locations of paper misfeeds, refer to *"Paper misfeed indications"* on page 4-5.

- 1 Open the right front door and the left front door.

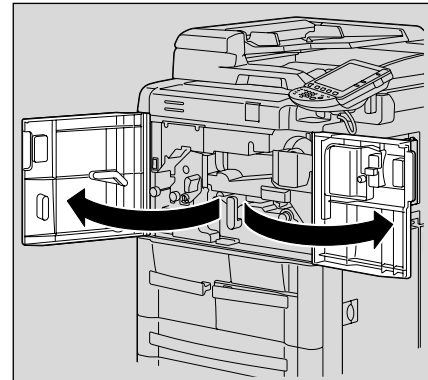

- 2 Lower lever M4, and then pull out the ADU unit.

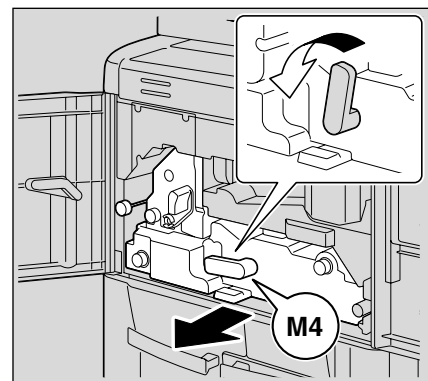

- 3 Remove all paper from the ADU unit.

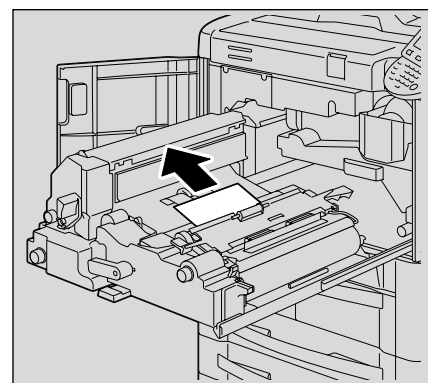

- 4 Return the ADU unit to its original position.

- 5 Return lever M4 to its original position, and then close the right front door and the left front door.

⚠ WARNING

Precaution for electrical shock

High voltage is generated around the drum unit inside the machine.

- In order to reduce the risk of electric shock, do not touch any part in this unit when clearing paper misfeeds.

⚠ CAUTION

Precaution for high temperature

The fusing unit inside the machine is extremely hot.

- In order to reduce the risk of burns, do not touch any part in this unit when clearing paper misfeeds.

4.2.12 Cleaning a paper misfeed in the ADU unit "11"



Note

For details of the locations of paper misfeeds, refer to *"Paper misfeed indications"* on page 4-5.

- 1 Open the right front door and the left front door.

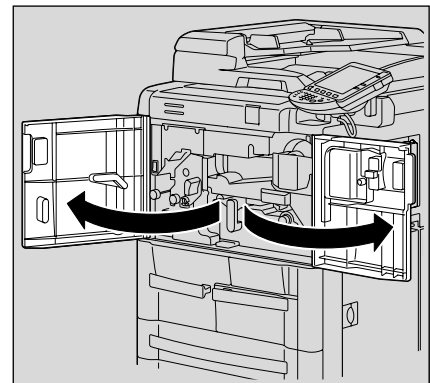

- 2 Turn dial M9 and M10 to feed out the paper.

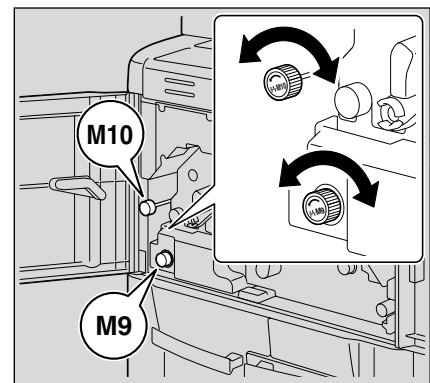

- 3 Remove all paper from the outlet.

- If the finisher, shift tray or Z folding unit is installed, clear paper misfeeds from each unit.

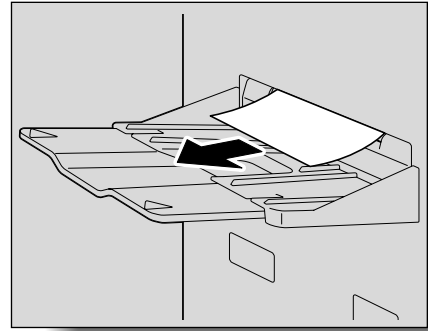

- 4 Lower lever M4, and then pull out the ADU unit.

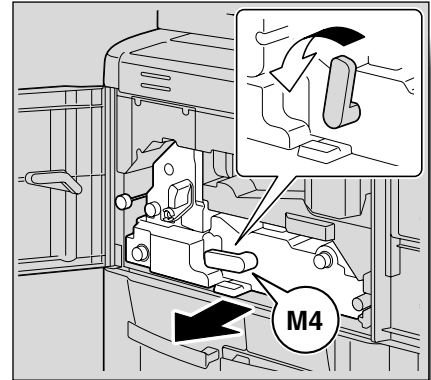

- 5 Lower lever M5.

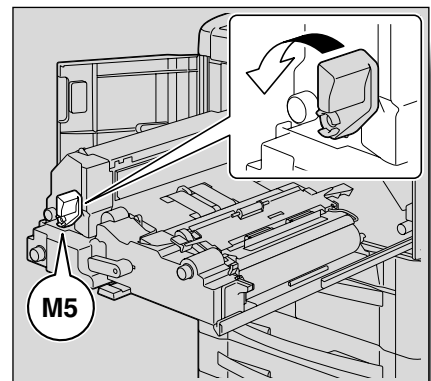

- 6 Open covers M6 and M8.

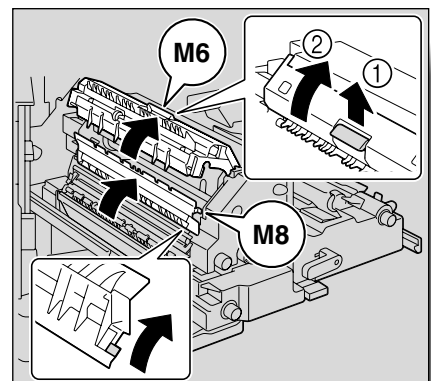

- 7 Turn dial M7, and then remove any paper.

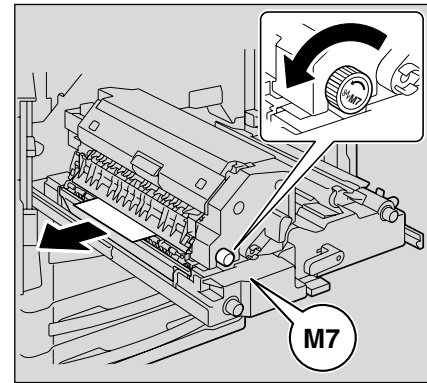

- 8 Raise the lever for cover M6, and then close cover M6.
- 9 Return the ADU unit to its original position.
- 10 Return lever M4 to its original position, and then close the right front door and the left front door.

⚠ WARNING

Precaution for electrical shock

High voltage is generated around the drum unit inside the machine.

- In order to reduce the risk of electric shock, do not touch any part in this unit when clearing paper misfeeds.

⚠ CAUTION

Precaution for high temperature

The fusing unit inside the machine is extremely hot.

- In order to reduce the risk of burns, do not touch any part in this unit when clearing paper misfeeds.

4.2.13 Cleaning a paper misfeed in the ADU unit "12"



Note

For details of the locations of paper misfeeds, refer to *"Paper misfeed indications"* on page 4-5.

- 1 Open the right front door and the left front door.

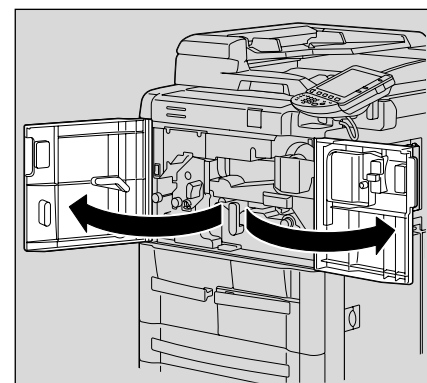

- 2 Lower lever M4, and then pull out the ADU unit.

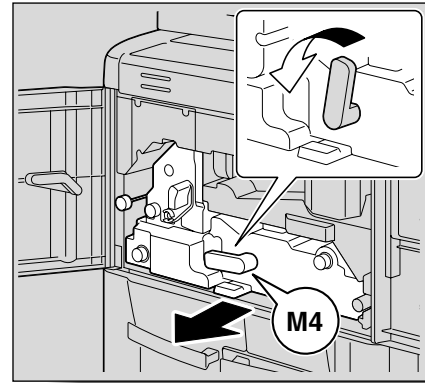

- 3 Open cover M11.

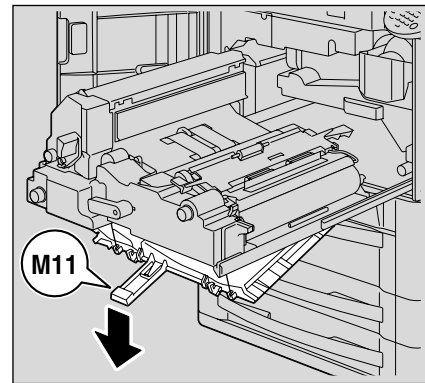

- 4 Turn dial M9, and then remove any paper.

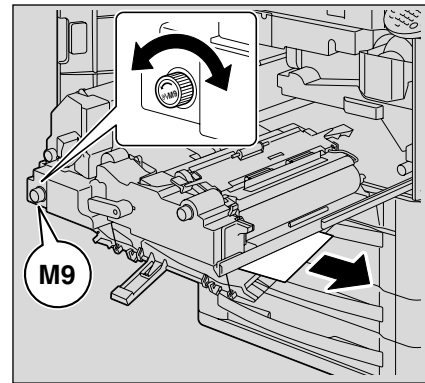

- 5 Return cover M11 to its original position.
- 6 Return the ADU unit to its original position.
- 7 Return lever M4 to its original position, and then close the right front door and the left front door.

⚠ WARNING

Precaution for electrical shock

High voltage is generated around the drum unit inside the machine.

- In order to reduce the risk of electric shock, do not touch any part in this unit when clearing paper misfeeds.

⚠ CAUTION

Precaution for high temperature

The fusing unit inside the machine is extremely hot.

→ In order to reduce the risk of burns, do not touch any part in this unit when clearing paper misfeeds.

4.2.14 Cleaning a paper misfeed in the ADU unit "13"



...

Note

For details of the locations of paper misfeeds, refer to *"Paper misfeed indications"* on page 4-5.

- 1 Open the right front door and the left front door.

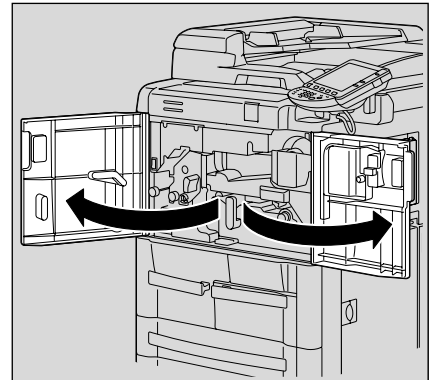

- 2 Lower lever M4, and then pull out the ADU unit.

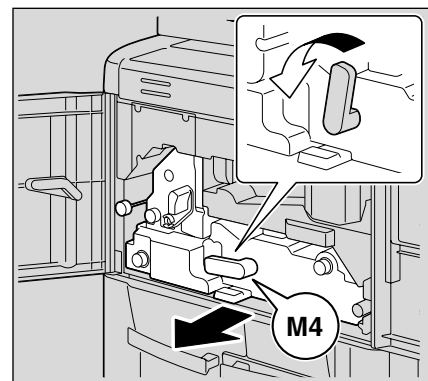

- 3 Open cover M11.

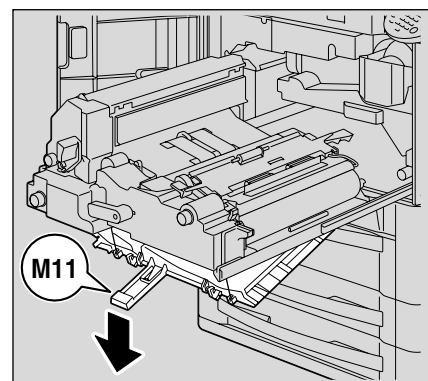

- 4 Remove any paper.

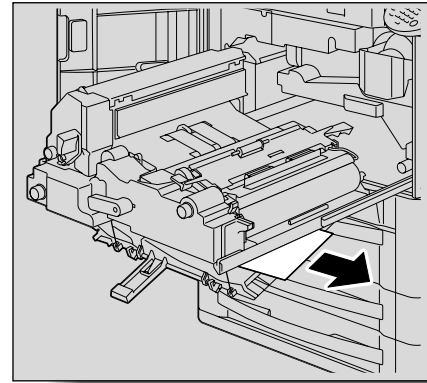

- 5 Return cover M11 to its original position.
- 6 Return the ADU unit to its original position.
- 7 Return lever M4 to its original position, and then close the right front door and the left front door.

⚠ WARNING

Precaution for electrical shock

High voltage is generated around the drum unit inside the machine.

- In order to reduce the risk of electric shock, do not touch any part in this unit when clearing paper misfeeds.

⚠ CAUTION

Precaution for high temperature

The fusing unit inside the machine is extremely hot.

- In order to reduce the risk of burns, do not touch any part in this unit when clearing paper misfeeds.

4.2.15 Cleaning a paper misfeed in the ADF "14"



Note

For details of the locations of paper misfeeds, refer to *"Paper misfeed indications"* on page 4-5.

- 1 Remove all original pages remaining in the paper tray.

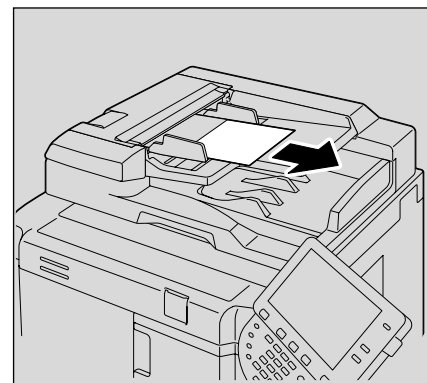

- 2 Open the left-side cover, and then remove any original pages.

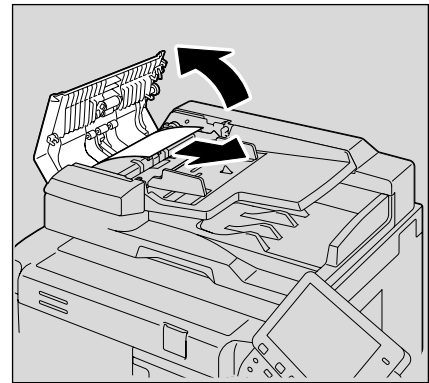

- 3 Open the paper feed unit, and then remove any original pages.

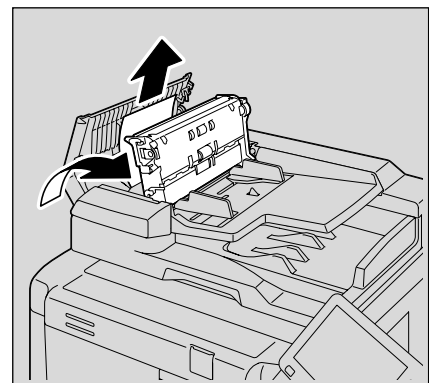

- 4 Close the paper feed unit and the left-side door.

- 5 Lift up the paper tray, and then remove any original pages.

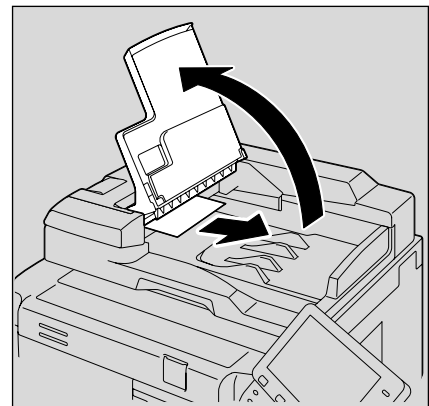

- 6 Return the paper tray to its original position.

4.2.16 Cleaning a paper misfeed in the ADF "15"



Note

For details of the locations of paper misfeeds, refer to *"Paper misfeed indications"* on page 4-5.

- 1 Remove all original pages remaining in the paper tray.

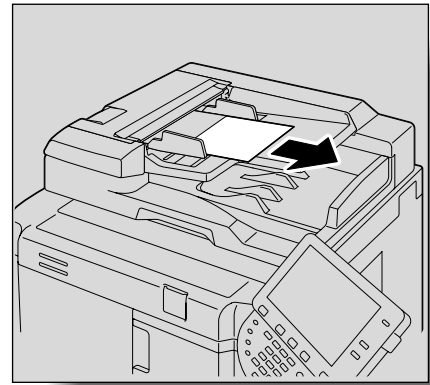

- 2 Lift open the ADF.

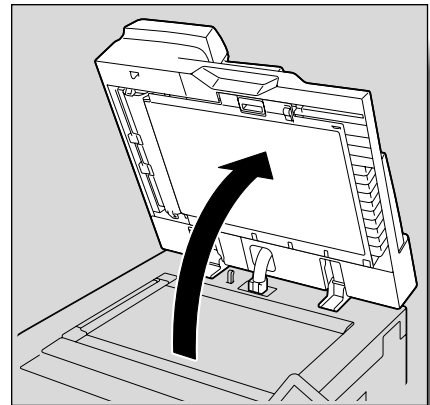

- 3 Open the document pad.

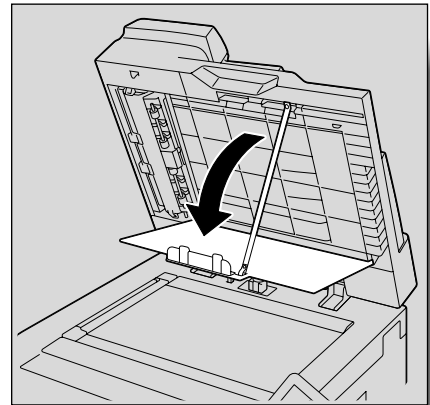

- 4 Open the original exit guides, and then remove any original pages.

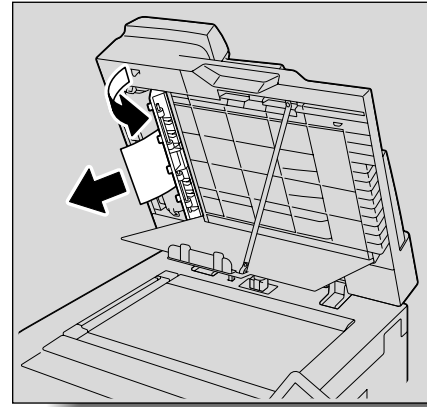

- 5 Close the document pad.

4.2.17 Clearing a paper misfeed in Finisher FS-524/FS-525 "16" "18"

This procedure describes the operations to be performed along the paper path where paper misfeeds may occur.

Depending on the selected Finishing settings, the paper path changes, resulting in different locations in the finisher where paper misfeeds may occur.

The method for clearing paper misfeeds in Finisher FS-524 is the same as that for FS-525. Here, the method for FS-524 is described as an example.

- 1 Open the machine's front door.

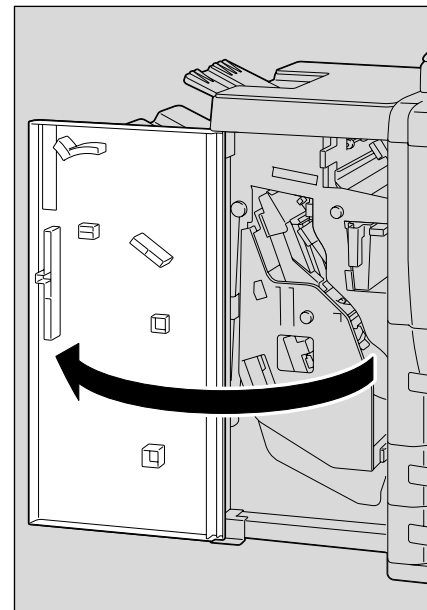

- 2 Lower guide lever FN2, and then remove any paper.

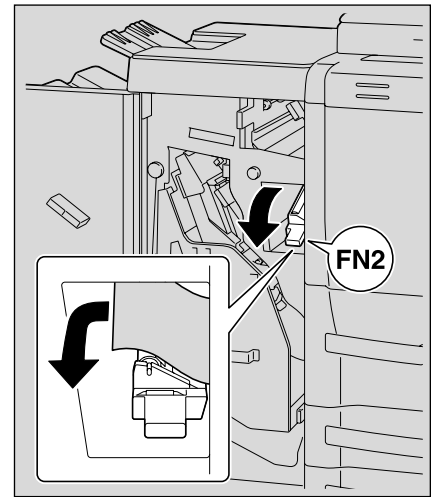

- 3 Return guide lever FN2 to its original position.
- 4 Lower guide lever FN4, and then remove any paper.

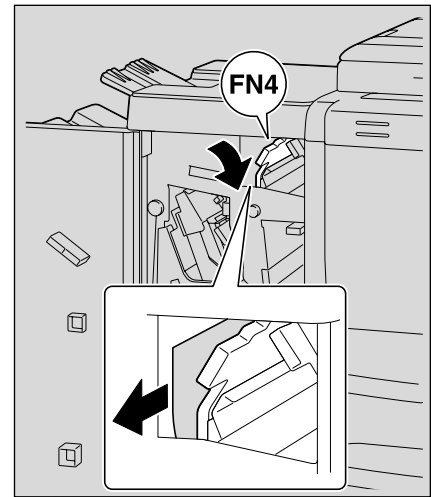

- If the paper cannot be removed, turn misfeed-clearing dial FN3 to feed out the paper.

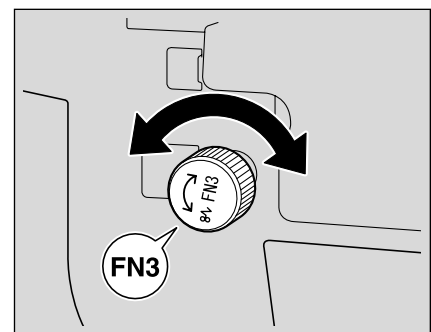

- 5 Return guide lever FN4 to its original position.

- 6** Lower guide lever FN5, and then remove any paper.

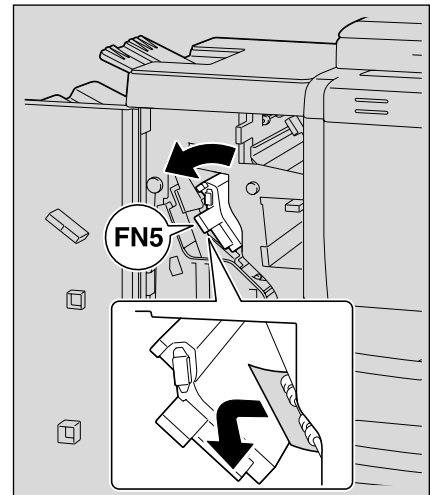

- If the paper cannot be removed, turn misfeed-clearing dial FN3 to feed out the paper.

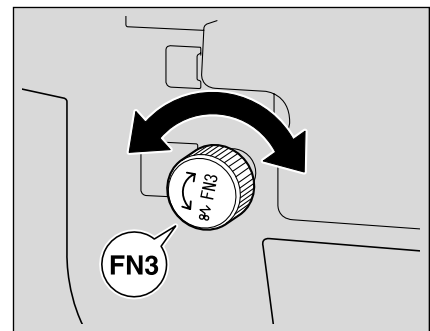

- 7** Return guide lever FN5 to its original position.

- 8** Grab handle FN7, and then pull out the stacker unit.

- Slowly pull out the stacker unit as far as possible.

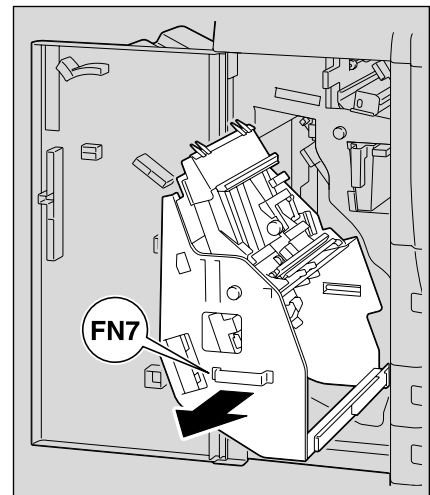

- 9** Remove any misfed paper from the stacker unit.

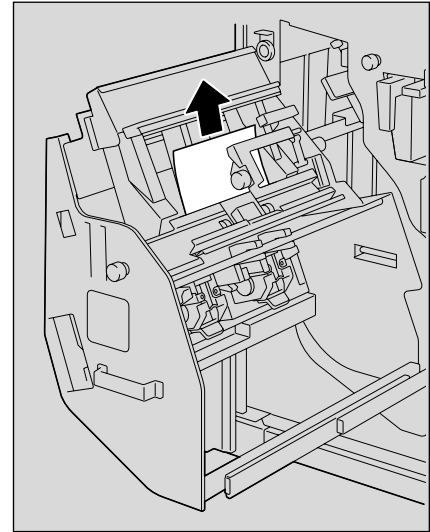

- If the paper cannot be removed, turn misfeed-clearing dial FN6 to feed out the paper.

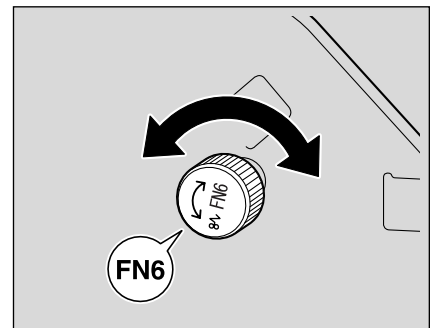

- 10** Return the stacker unit to its original position.

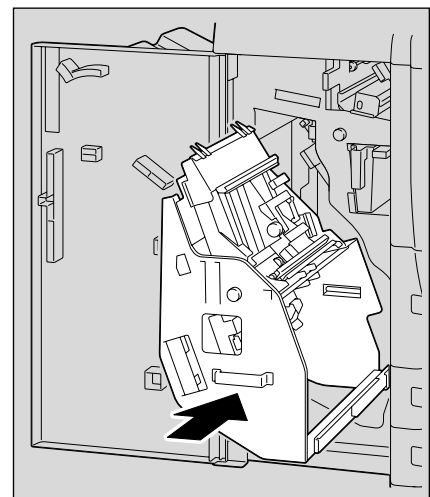

- When returning the stacker unit to its original position, do not grab any part other than handle FN7, otherwise your hand or fingers may be pinched.

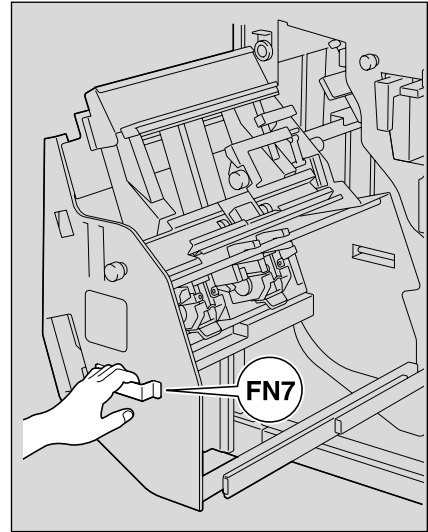

11 Close the front door.

4.2.18 Clearing a paper misfeed in Finisher FS-610 "16" "18"

This procedure describes the operations to be performed along the paper path where paper misfeeds may occur.

Depending on the selected Finishing settings, the paper path changes, resulting in different locations in the finisher where paper misfeeds may occur.

- 1 Open the machine's front door.

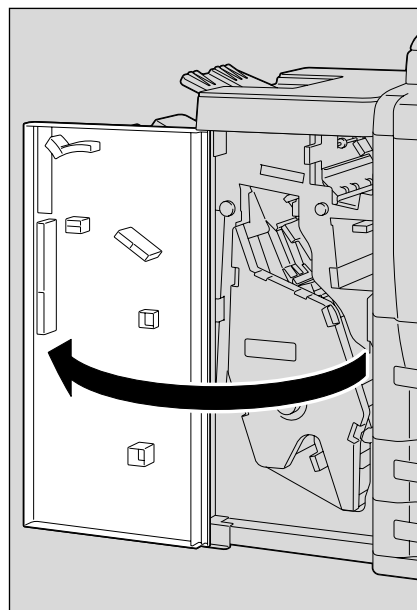

- 2 Lower guide lever FN2, and then remove any paper.

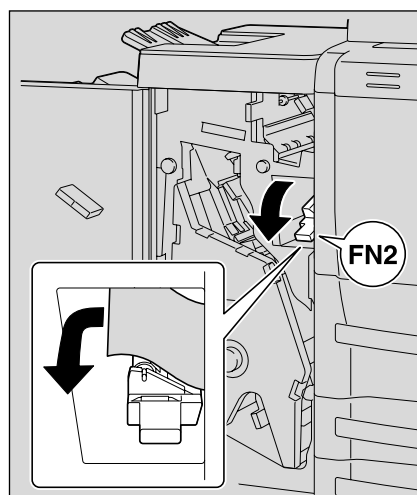

- 3 Return guide lever FN2 to its original position.
- 4 Lower guide lever FN4, and then remove any paper.

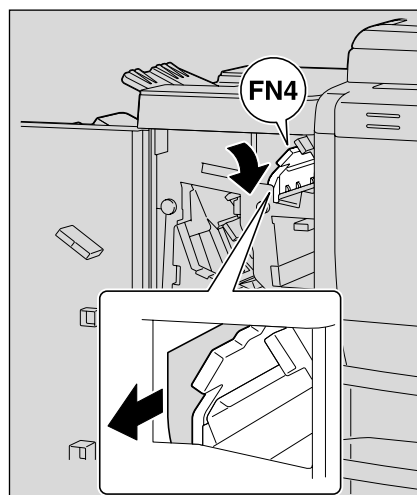

- If the paper cannot be removed, turn misfeed-clearing dial FN3 to feed out the paper.

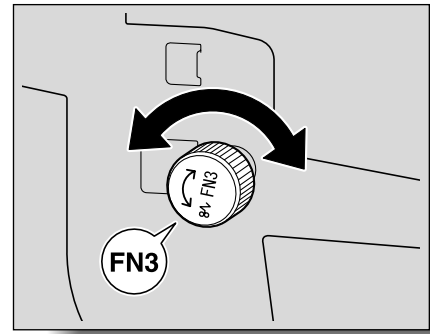

- 5 Return guide lever FN4 to its original position.
- 6 Lower guide lever FN5, and then remove any paper.

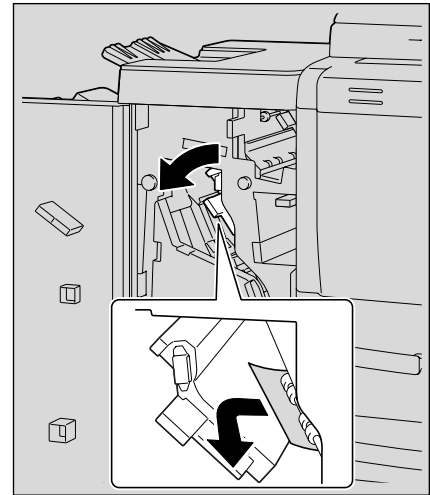

- If the paper cannot be removed, turn misfeed-clearing dial FN3 to feed out the paper.

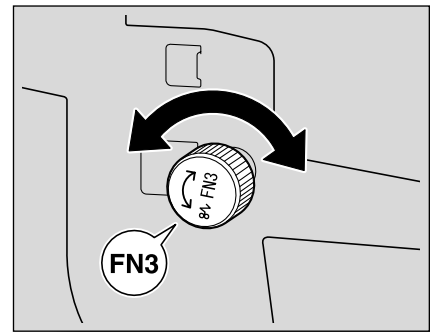

- 7 Return guide lever FN5 to its original position.

- 8 Grab handle FN6, and then pull out the stacker unit.
 - Slowly pull out the stacker unit as far as possible.

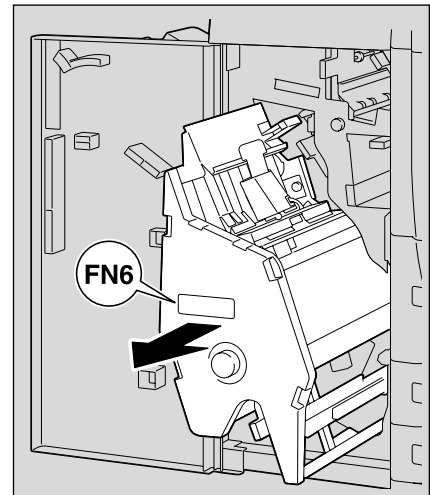

- 9 Lower guide lever FN9, and then remove any paper.

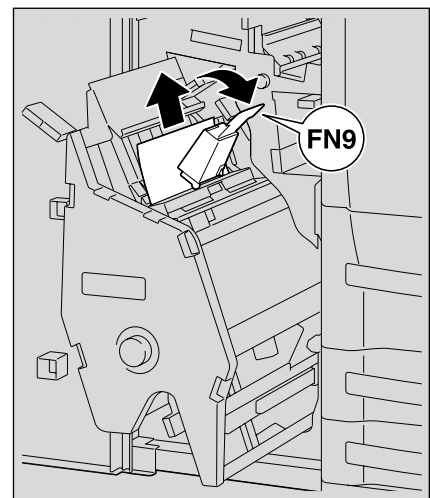

- 10 Open guide lever FN8, and then remove any paper.

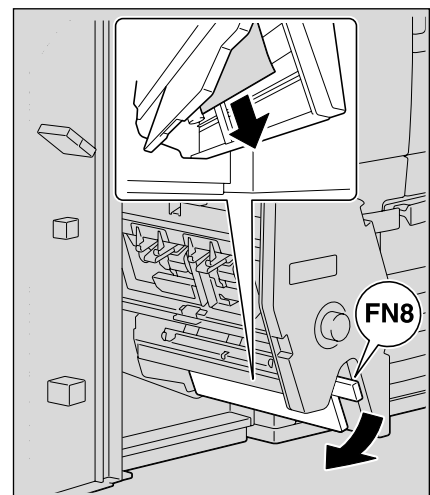

- If the paper cannot be removed, turn misfeed-clearing dial FN7 to feed out the paper.

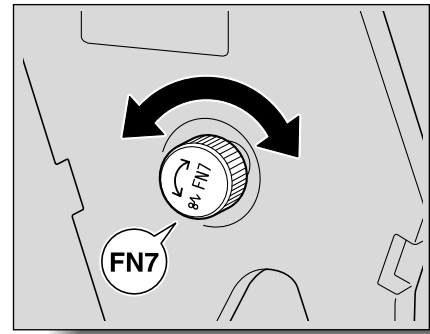

11 Lower guide lever FN10, and then remove any paper.

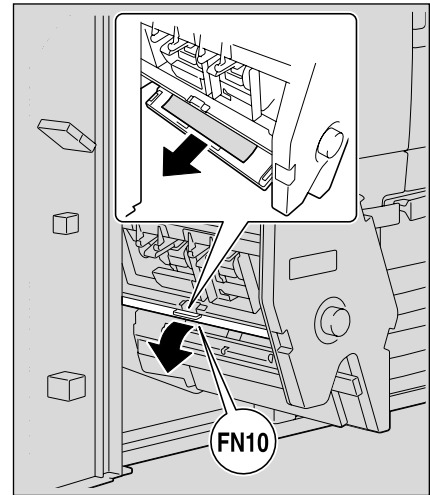

- If the paper cannot be removed, turn misfeed-clearing dial FN7 to feed out the paper.

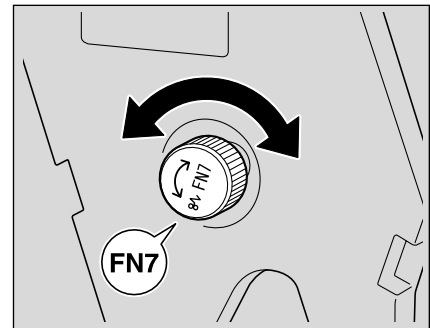

12 Return the stacker unit to its original position.

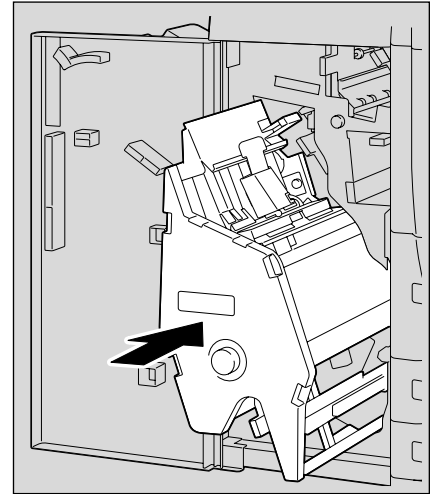

- When returning the stacker unit to its original position, do not grab any part other than handle FN6, otherwise your hand or fingers may be pinched. Return the stacker unit to its original position.

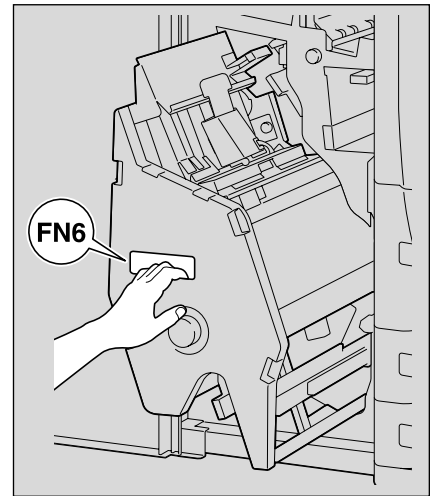

13 Close the front door.

4.2.19 Clearing a paper misfeed in the shift tray "16"

- 1 Open the shift tray cover, and then slowly remove any misfed paper.

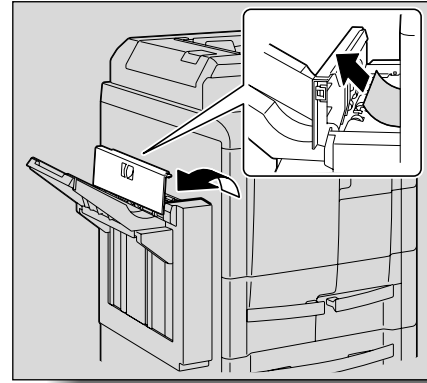

- 2 Close the shift tray cover.

4.2.20 Clearing a paper misfeed in the post inserter "17"



Detail

For details on the positions of paper misfeeds, refer to *"Paper misfeed indications"* on page 4-5

- 1 Raise the upper unit release lever, and then slide the upper unit to the left.

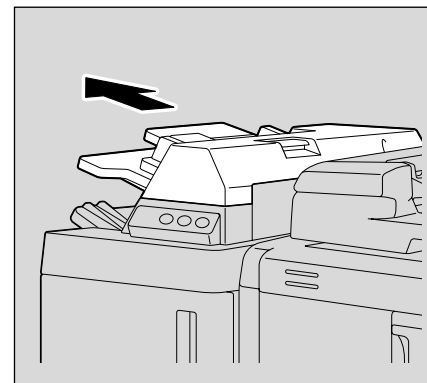

- 2 Slowly remove any misfed paper.

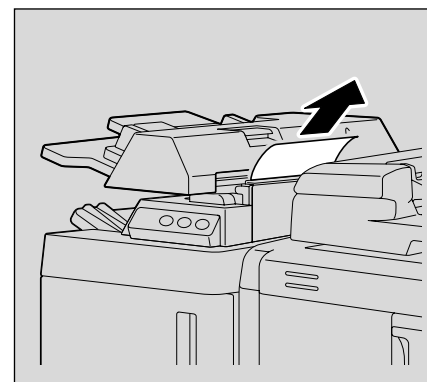

- 3 Return the upper unit to its original position.

4.2.21 Clearing a paper misfeed in the Z folding unit "20"

This procedure describes the operations to be performed along the paper path where paper misfeeds may occur.

Depending on the selected Finishing settings, the paper path changes, resulting in different locations in the Z folding unit where paper misfeeds may occur.

- 1 Open the machine's front door.

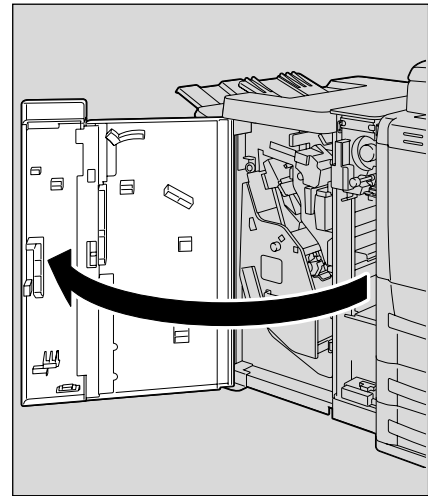

- 2 Raise guide lever FN1, and then remove any paper.

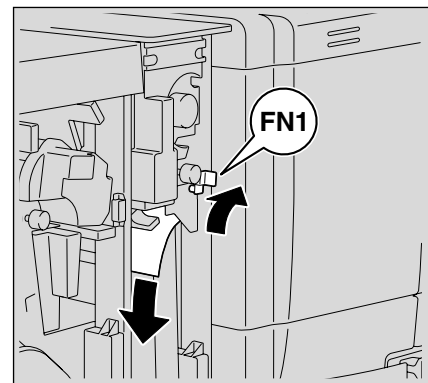

- 3 Return guide lever FN1 to its original position.

- 4 Lower guide lever FN8 and guide lever FN2 of the finisher, and then remove any paper.

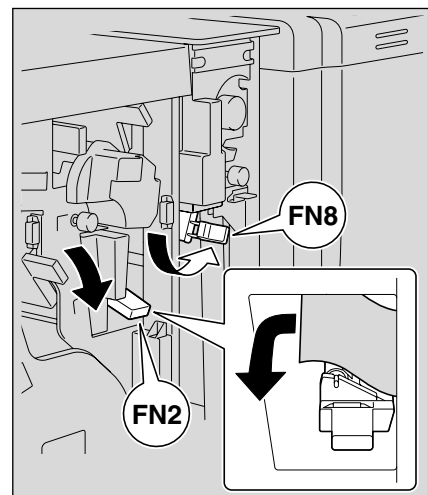

- 5** Grab handle FN2, and then pull out the Z folding/transport unit.
- Slowly pull out the Z folding/transport unit as far as possible.

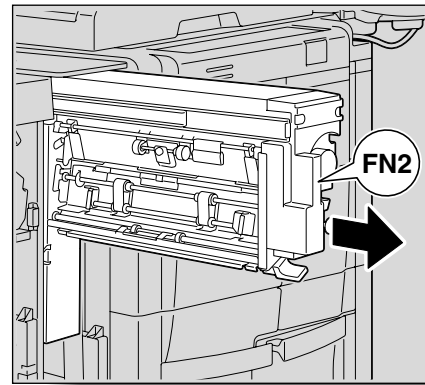

- 6** Lower guide lever FN3, and then remove any paper.

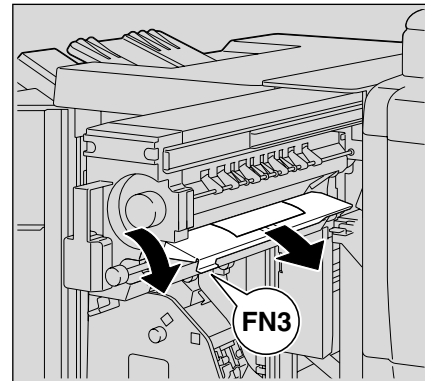

- If the paper cannot be removed, turn misfeed-clearing dial FN4 to feed out the paper.

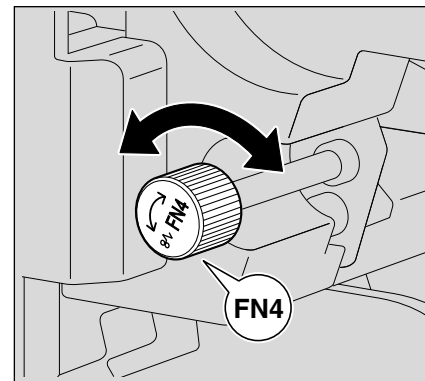

- 7** Lower guide lever FN6, and then remove any paper.

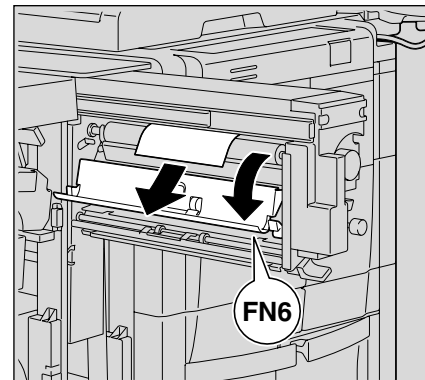

- 8 Raise guide lever FN7, and then remove any paper.

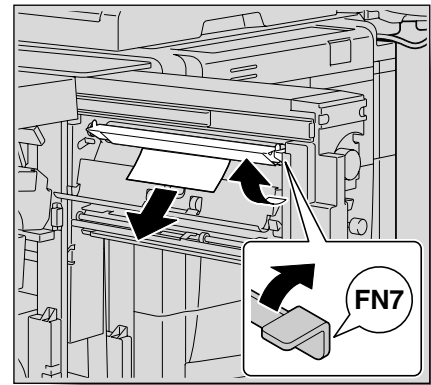

- If the paper cannot be removed, turn misfeed-clearing dial FN5 to feed out the paper.

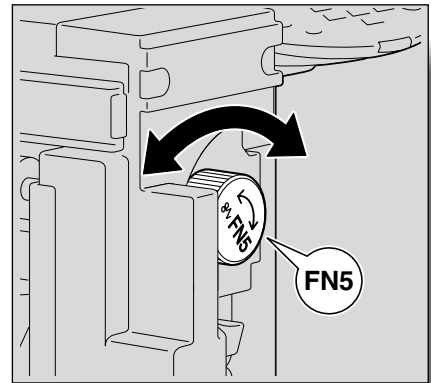

- 9 Return guide lever FN6 to its original position

- 10** Return the Z folding/transport unit to its original position.

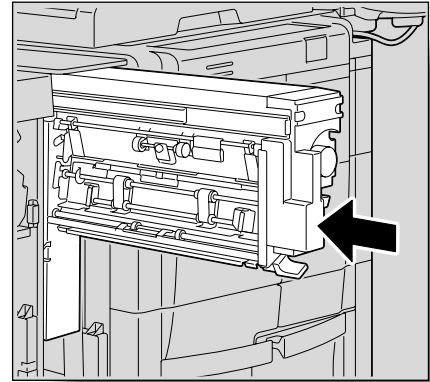

- When returning the Z folding/transport unit to its original position, do not grab any part other than handle FN2, otherwise your hand or fingers may be pinched.

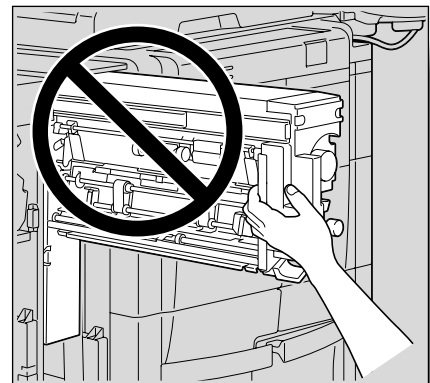
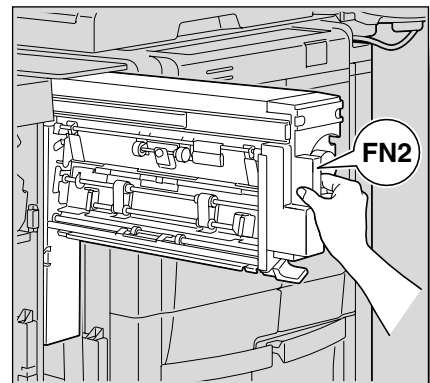

- 11** Close the front door.

4.3 Simple troubleshooting

	Symptom	Possible cause	Remedy
Main unit	The machine does not start up when the main power switch is turned on.	Is no power supplied from the electrical outlet?	Correctly insert the power supply plug into the electrical outlet.
		Has the [Power] (auxiliary power) key been turned on?	Turn on the [Power] (auxiliary power) key.
	Copying does not start.	Is the upper right-side door of the machine open?	Securely close the upper right-side door of the machine.
		Is there no paper that matches the original?	Load paper of the appropriate size into the paper tray.
	The printed output is too light.	Is the copy density set too light?	Touch [Dark] in the Density screen to copy at the desired copy density. (See p. 2-52.)
		Is the paper damp?	Replace the paper with new paper. (See p. 1-47 , p. 1-48 and p. 1-53.)
	The printed output is too dark.	Is the copy density set too dark?	Touch [Light] in the Density screen to copy at the desired copy density. (See p. 2-53.)
		Was the original not pressed close enough against the original glass?	Position the original so that it is pressed closely against the original glass. (See p. 2-7.)
	The printed output is blurry.	Is the paper damp?	Replace the paper with new paper. (See p. 1-47 , p. 1-48 and p. 1-53.)
		Was the original not pressed close enough against the original glass?	Position the original so that it is pressed closely against the original glass. (See p. 2-7.)
	There are dark specks or spots throughout the printed output. There are streaks in the printed output.	Is the original glass dirty?	Wipe the glass with a soft, dry cloth. (See p. 9-2.)
		Is the left partition glass dirty?	Clean the left partition glass with a soft, dry cloth. (See p. 9-2.)
		Is the document pad dirty?	Clean the document pad with a soft cloth dampened with a mild detergent. (See p. 9-2.)
		Was the original printed on highly translucent material, such as diazo photosensitive paper or OHP transparencies?	Place a blank sheet of paper on top of the original. (See p. 2-7.)
		Is a double-sided original being copied?	If a thin double-sided original is being copied, the print on the back side may be reproduced in the copy. Touch [Light] on the Background Removal screen to select a lighter background density. (See p. 2-44.)

	Symptom	Possible cause	Remedy
	The image is not aligned properly on the paper.	Is the original incorrectly positioned?	Correctly position the original against the original scales. (See p. 2-7.) Load the original into the ADF, and slide the adjustable paper guides to fit the size of the original. (See p. 2-6.)
		Is the original incorrectly positioned in the ADF?	If the original cannot be fed correctly through the ADF, make copies by positioning the original on the original glass. (See p. 2-7.)
		Is the left partition glass dirty (while using the ADF)?	Clean the left partition glass with a soft, dry cloth. (See p. 9-2.)
		Are the adjustable lateral guides incorrectly positioned against the edges of the original?	Slide the adjustable lateral guides against the edges of the original.
		Was curled paper loaded into the paper tray?	Flatten the paper before loading it.
	The printed page is curled.	Was paper that curls easily (as with recycled paper) used?	Remove the paper from the paper tray, turn it over, and then load it again. Replace the paper with paper that is not damp. (See p. 1-47 , p. 1-48 and p. 1-53.)
		Is the document pad dirty?	Clean the document pad with a soft cloth dampened with a mild detergent. (See p. 9-2.)
	The edge of the printed output is dirty.	Was the selected paper size larger than the original (with a Zoom setting of "Full Size" (100.0%)?	Select a paper size that is the same size as the original. Otherwise, select the "Auto" Zoom setting to enlarge the copy to the selected paper size. (See p. 2-30.)
		Is the orientation of the original different from the orientation of the paper (with a Zoom setting of "Full Size" (100.0%)?	Select a paper size that is the same size as the original. Otherwise, select a paper orientation that is the same as that of the original.
		Was the copy reduced to a size smaller than the paper (with a reduced zoom ratio specified)?	Select a zoom ratio that adjusts the original size to the selected paper size. (See p. 2-30.) Otherwise, select the "Auto" Zoom setting to reduce the copy to the selected paper size. (See p. 2-32.)
		Are there paper misfeeds at other locations?	Check the touch panel for other paper misfeed indications, and then remove any misfed paper at all other locations. (See p. 4-5.)
	Even though the paper misfeed was cleared, copies cannot be produced.	Have settings been selected that cannot be combined?	Check the combinations of the selected settings.
	Printing with the "2-Sided > 1-Sided" or "2-Sided > 2-Sided" settings are not possible.	Did the message "Your account has reached its maximum allowance." appear?	Contact your administrator.
ADF	The original is not fed.	Is the ADF slightly open?	Securely close the ADF.
		Is the original one that does not meet the specifications?	Check that the original is one that can be loaded into the ADF. (See p. 6-29 and p. 6-30.)
		Is the original correctly loaded?	Position the original correctly. (See p. 2-6.)

	Symptom	Possible cause	Remedy
Finisher	The finisher cannot be used.	Is no power supplied to the connector?	Check that the cord is correctly inserted into the connector.
	The pages cannot be stapled.	Have the staples run out?	Replace the staple cartridge. (See p. 8-6.)
	The staple is incorrectly positioned by 90 degrees.	Is the staple position correctly specified?	Specify the desired position for stapling. (See p. 2-60.)
	The pages that were fed out were not uniformly loaded and the punched holes or staples are incorrectly positioned.	Is the paper curled?	Remove the paper from the paper tray, turn it over, and then load it again.
		Is there a gap between the lateral guides in the paper tray and the sides of the paper?	Slide the lateral guides in the paper tray against the sides of the paper so that there is no gap.
Even though a Punch setting was selected, holes are not punched. (when the punch unit is installed on the finisher)	Did the message "Empty the hole-punch scrap box." appear?	Empty the hole-punch scrap box. (See p. 8-18)	

	Trouble	Possible cause	Remedy
Authentication Unit (Biometric Type)	The USB cable is connected between the authentication unit and the machine, but the status indicator is not lit in green.	The USB port of the machine may be malfunctioning.	Turn the machine off with the main power switch and temporarily disconnect the USB cable from the authentication unit or the machine before connecting it again and waiting 10 seconds before turning on the machine with the main power switch.
	The USB cable is connected between the authentication unit and the computer, but the status indicator is not lit in green.	The USB port of the computer may be malfunctioning.	Restart the computer.
		Is the authentication unit correctly installed?	Refer to "Registering from Data Administrator", and check if the driver is correctly installed on the computer. (p. 12-6)
	A tone does not sound from the machine when scanning begins and when authentication is completed.	Has the tone setting on the machine been set to "OFF"?	Refer to "Registering users", and set the tone setting to "ON". (p. 12-11)
	The message "Failed to register". appears on a machine where registration failed.	With the authentication unit, the scanning time is limited for each scan. This message appears if scanning is not possible within the limited period of time. For details on the scanning time, consult with the technical representative.	Refer to the Quick Guide Authentication Unit (Biometric Type AU-101) and check how to position the finger for authentication and scanning in order to complete scanning within the limited period of time. Correctly position the finger to be scanned on the scanner, and do not move the finger until the scanning results are received. If the area of the finger to be scanned is dirty or chapped, a correct image cannot be created and scanning may not be completed. Wash your hands and try scanning again, or try to correct chapped fingers. If the area of the finger to be scanned is too wide or too thin (outside of the finger width range of 10 mm to 25 mm), a correct image cannot be created and scanning may not be completed. Try widening your finger or inserting it deeper or less deep into the scanner.
	Logon failed. The message "Failed to Authenticate." appears on the machine.		
The message "Failed to read data. Place your finger once again and click the [Start reading] button." appears on a computer where registration failed.	With the authentication unit, the scanning time is limited to five seconds for each scan. This message appears if scanning is not possible within the five-second time period.		

	Trouble	Possible cause	Remedy
	Scanning does not begin.	Is the finger correctly positioned?	Refer to the Quick Guide Authentication Unit (Biometric Type AU-101) and check how to position the finger for authentication and scanning. Correctly position the finger to be scanned on the scanner, and do not move the finger until the scanning results are received. If the area of the finger to be scanned is dirty or chapped, a correct image cannot be created and scanning may not be completed. Wash your hands and try scanning again, or try to correct chapped fingers. If the area of the finger to be scanned is too wide or too thin (outside of the finger width range of 10 mm to 25 mm), a correct image cannot be created and scanning may not be completed. Try widening your finger or inserting it deeper or less deep into the scanner.
		Was the machine restarted after the authentication unit was connected to it?	Turn the machine off with the main power switch and temporarily disconnect the USB cable from the authentication unit or the machine before connecting it again and waiting 10 seconds before turning on the machine with the main power switch.
	The Add New Hardware Wizard starts when the authentication unit is connected to the computer.	Is the authentication unit connected to the same USB port used when the driver was installed?	If the authentication unit is connected to a USB port different from the one used when the driver was installed, the Add New Hardware Wizard may start. Use the same USB port used when the driver was installed.
Authentication Unit (IC Card Type)	The USB cable is connected between the authentication unit and the machine, but the status indicator is not lit in green.	With the authentication unit, the scanning time is limited to 10 seconds. This message appears if scanning was not possible within the limited period of time.	Refer to the Quick Guide Authentication Unit (IC Card Type AU-201) and check how to position the IC card in order to complete scanning within the limited period of time.
	The message appears on a computer where registration failed		
	Logon failed. The message "Failed to Authenticate." appears on the machine.	If "Card Authentication + Password" was selected: Is the password typed in correctly?	Check the password, and type it in correctly.
	Scanning does not begin.	Was the machine restarted after the authentication unit was connected to it?	Turn the machine off with the main power switch and temporarily disconnect the USB cable from the authentication unit or the machine before connecting it again and waiting 10 seconds before turning on the machine with the main power switch.
	The Add New Hardware Wizard starts when the authentication unit is connected to the computer.	Is the authentication unit connected to the same USB port used when the driver was installed?	If the authentication unit is connected to a USB port different from the one used when the driver was installed, the Add New Hardware Wizard may start. Use the same USB port used when the driver was installed.

If any message other than those listed above appears, perform the operation described in the message. If the problem is not corrected after the described operation is performed, contact your service representative.

4.4 Main messages and their remedies

Message	Cause	Remedy
Originals left on original glass.	The original was left on the original glass.	Remove the original from the original glass.
Paper of matching size is not available. Select the paper size.	Paper of a suitable size is not loaded in a paper tray.	Either select paper of a different size or load paper of a suitable size.
Load paper into the bypass tray.	Paper of a suitable size is not loaded in the bypass tray.	Load paper of the appropriate size into the bypass tray.
The original size cannot be detected. Select the paper size.	1: The original is not positioned correctly. 2: An original with a non-standard size or with a size too small to be detected is loaded.	1: Position the original correctly. 2: Select the correct paper size.
The image will not fit on selected paper. Change the direction of the original.	The image does not fit in the paper.	Load the original turned 90 degrees.
Cannot be set with XXX.	Functions that cannot be used together are selected.	Make copies using only one of the functions.
The output tray has reached its capacity. Remove all paper from the tray indicated by →.	Since the maximum amount of copies for the indicated finisher output tray has been exceeded, the machine is unable to make copies.	Remove all paper from the indicated tray.
Enter User Name and password, and then touch [Login] or press the [Access] key.	User authentication settings have been specified. Copies cannot be made unless a user name and its correct password are entered.	Type in your user name and password. (See p. 1-35.)
Enter Account Name and password, and then touch [Login] or press the [Access] key.	Account track settings have been specified. Copies cannot be made unless an account name and its correct password are entered.	Type in your user name and password. (See p. 1-38.)
Your account has reached its maximum allowance.	The limit on the number of pages that can be printed has been reached.	Contact the administrator of the machine.
The part indicated by → is open. Ensure that it is properly closed.	Since a machine door or cover is open or an option is not installed correctly, the machine is unable to make copies.	Make sure that all doors and covers are closed and that all options are installed correctly.
Install toner cartridge, and close all doors.	The toner cartridge is not installed correctly.	Reinstall the supplies or parts, or contact your service representative.
Replenish paper.	The indicated tray has run out of paper.	Load paper into the indicated tray. (See p. 1-47 , p. 1-48 , and p. 1-53.)
No more staples. Replace the staple cartridge, or cancel stapling.	The staples have run out.	Replace the staple cartridge. (See p. 8-6.)
Misfeed detected.	Since a paper misfeed occurred, the machine is unable to make copies.	Clear the paper misfeed. (See p. 4-4.)
Reinsert the following # of originals.	After clearing a paper misfeed, it is necessary to reload certain pages of the original that have already been fed through the ADF.	Load the indicated original pages into the ADF.
An internal error occurred. Open and then close the front door. If the trouble code appears again contact your Service Rep.	The machine malfunctioned and is unable to make copies.	Clear the error by following the on-screen instructions. If the error cannot be cleared or released, contact your service representative with the error code displayed on the screen.
Malfunction detected. Please call your Service Rep.	The machine malfunctioned and is unable to make copies.	Inform your service representative of the code displayed on the touch panel.
Now Downloading Program Data from Firmware server.	1: CS Remote Care was activated by the service representative. 2: Internet ISW is being downloaded.	Do not turn off the machine with the [Power] (auxiliary power) key while this message is displayed. After turning off the machine with the [Power] (auxiliary power) key, turn off the main power switch, and then contact the service representative.

Message	Cause	Remedy
Cannot be accessed due to unauthorized access. Please contact your administrator.	The authentication information has become invalid since the authentication attempts have failed the specified number of times.	Contact the administrator of the machine.
The Administrator Password is not valid due to unauthorized access.	The administrator password has become invalid since the authentication attempts have failed the specified number of times.	Turn the machine off, then on again. Turn off the main power switch, and then wait about 10 seconds before turning it on again.





































































If any message other than those listed above appears, perform the operation described in the message.

5 Specifications

5 Specifications





5.1 Specifications

5.1.1 Main unit

Item	Description
Name	bizhub 751/601
Type	Console
Document holder	Stationary (mirror scanning)
Photoconductor	OPC
Luminous source	White inert gas fluorescent lamp
Copying system	Laser electrostatic copy method
Developing system	Dry-type dual-component reverse magnetic brush developing
Fusing system	Heat roller fixing
Resolution	Scanning: 600 dpi × 600 dpi, Printing: 1200 dpi × 600 dpi
Document	Types: sheets, books (spread), three-dimensional objects Size: Max. 11-11/16 × 17 Thickness: Max. 1-3/16, Weight: 15 lb Detectable sizes for original glass: 11 × 17  , 8-1/2 × 14  , 8-1/2 × 11   , 5-1/2 × 8-1/2   , A3  , B4  , A4   , B5   , A5  , B6  Detectable sizes for ADF: 11 × 17  , 8-1/2 × 14  , 8-1/2 × 11   , 7-1/4 × 10-1/2   , 5-1/2 × 8-1/2   , A3  , B4  , A4   , B5   , B6 
Paper types	Normal paper: 16 lb to 24 lb, thin paper ^{*1} : 13-1/4 lb to 15-3/4 lb, thick paper: 24-1/4 lb to 53-1/4 lb, overhead projector transparencies ^{*1} , labels ^{*1} , tab paper ^{*1} , trace paper ^{*1} , special paper ^{*1} , high-quality paper, user paper, recycled paper, colored paper, letter-head
Paper sizes	Tray 1 and tray 2: 8-1/2 × 11  , 5-1/2 × 8-1/2  , A4  , B5  , A5  Tray 3 and tray 4: Standard sizes: 11 × 17  , 8-1/2 × 14  , 8-1/2 × 11   , 5-1/2 × 8-1/2  , A3  , B4  , A4   , Foolscap ^{*2} , wide paper (11 × 17W  , 8-1/2 × 11W   , 5-1/2 × 8-1/2W   , A3W  , B4W  , A4W  , B5W  ) Custom sizes: 7-3/16 × 5-1/2 to 12-3/8 × 18-1/16 Bypass tray: Standard sizes: 11 × 17  , 8-1/2 × 14  , 8-1/2 × 11   , 5-1/2 × 8-1/2   , A3  , B4  , A4   , B5   , wide paper (11 × 17W  , 8-1/2 × 11W   , 5-1/2 × 8-1/2W   , A3W  , B4W  , A4W  , B5W  ) Custom sizes: 3-15/16 × 5-1/2 to 12-3/8 × 18-1/16
Image blank	Single-sided copying: Leading edge and trailing edge: less than 1/8, front and rear: less than 1/16 Double-sided copying: Front side: Leading edge and trailing edge: less than 3/16, front and rear: less than 1/16 Back side: Leading edge and trailing edge: less than 1/8, front and rear: less than 1/16
Paper tray capacity	Tray 1: 1500 sheets (21-1/4 lb plain paper) Tray 2: 1000 sheets (21-1/4 lb plain paper) Tray 3 and tray 4: 500 sheets (21-1/4 lb plain paper) Bypass tray: 100 sheets (21-1/4 lb plain paper)
Warm-up time	bizhub 751: within 300 seconds, bizhub 601: within 270 seconds
First copy	bizhub 751: within 3.0 seconds, bizhub 601: within 3.5 seconds
Copy speed	bizhub 751: 75 sheets/min. (8-1/2 × 11  , 34 sheets/min. (11 × 17 ) bizhub 601: 60 sheets/min. (8-1/2 × 11  , 29 sheets/min. (11 × 17 )

Item	Description
Magnification ratios	Full size: $\times 1.000 \pm 1.0\%$ or less Enlargement (Fixed Zoom): $\times 1.214, \times 1.294, \times 1.545, \times 2.000$ Reduction (Fixed Zoom): $\times 0.500, \times 0.647, \times 0.772, \times 0.785$ Minimal Copy: 0.930 Zoom with Constant X and Y Ratio: $\times 0.250$ to 4.000 (in 0.001 increments) Independent Zoom: vertical $\times 0.250$ to 4.000 (in 0.001 increments), horizontal $\times 0.250$ to 4.000 (in 0.001 increments) User-set zoom ratio: 3
Multiple copies/sets	1 to 9999 copies/1 to 9999 sets
Density adjustment	Copy Density: Automatic and manual (9 levels) Background adjustment: Manual (9 levels)
Power requirements	AC 120 V, 16 A, 60 Hz
Noise	75 dB or less (bizhub 751/601)
Power consumption	Max. 1,920 W (including options)
Dimensions	35 (W) \times 33-3/4 (D) \times 45 (H) (main unit, ADF and control panel)
Space requirements *3	50-1/4 (W) \times 31-1/4 (D) (main unit and ADF)
Memory	1 GB
Weight	Approx. 496 lb (Main unit and ADF)















*1 Can only be fed through the bypass tray.

*2 Foolscap includes the following 4 types: 8-1/8 \times 13-1/4 , 8-1/4 \times 13 , 8-1/2 \times 13 , and 8 \times 13 , one of which can be selected. For details, contact the service representative.

*3 The indicated spaced requirements represent the space required to fully extend the bypass tray.



In order to incorporate improvements, these product specifications are subject to change without notice.

5.1.2 Automatic Document Feeder DF-614









Item	Description
Name	DF-614
Document feed methods	Standard original: Single-sided, double-sided Mixed original: Single-sided, double-sided
Original paper types	13-1/4 lb to 53-1/4 lb
Original sizes	3-15/16 \times 5-1/2 to 11-11/16 \times 17 Detectable sizes: 11 \times 17  , 8-1/2 \times 14  , 8-1/2 \times 11  /  , 7-1/4 \times 10-1/2  /  , 5-1/2 \times 8-1/2  /  , A3  , B4  , A4  , B5  /  , B6 
Capacity of document feeder	Max. 100 sheets (21-1/4 lb)
Power requirements	Supplied from main unit
Maximum power consumption	53 W or less
Dimensions	24-1/2 (W) \times 22-3/4 (D) \times 6 (H)
Weight	Approx. 28-1/2 lb





5.2 Option Specifications

5.2.1 Large Capacity Unit LU-405

Item	Description
Name	LU-405
Paper types	Normal paper (16 lb to 24 lb)
Paper sizes	Standard sizes: 8-1/2 × 11  , A4  , 16K  Custom sizes: 7-3/16 × 10-1/8 to 8-3/4 × 12-3/8
Paper tray capacity	4,000 sheets (20 lb)
Power requirements	Supplied from main unit
Maximum power consumption	82 W or less
Dimensions	17 (W) × 25-1/4 (D) × 27-1/4 (H)
Weight	Approx. 66 lb
Configuration	1 paper tray

5.2.2 Large Capacity Unit LU-406

Item	Description
Name	LU-406
Paper types	Normal paper (16 lb to 24 lb)
Paper sizes	Standard sizes: 11 × 17  , 8-1/2 × 14  , 8-1/2 × 11  , A3  , B4  , A4  , Foolscap*, 8K  , 16K  Custom sizes: 7-3/16 × 10-1/8 to 12-3/8 × 18-1/8
Paper tray capacity	4,000 sheets (20 lb)
Power requirements	Supplied from main unit
Maximum power consumption	100 W or less
Dimensions	26-1/2 (W) × 25-1/4 (D) × 27-1/4 (H)
Weight	Approx. 92-1/2 lb
Configuration	1 paper tray

* Foolscap includes the following 4 types: 8-1/8 × 13-1/4 , 8-1/4 × 13 , 8-1/2 × 13 , 8 × 13 , one of which can be selected. For details, contact the service representative.

5.2.3 Finisher FS-524

Item	Description
Name	FS-524
Function	Straight delivery (sorted, grouped) Offset delivery (sort and offset, group and offset) Staple delivery
Output trays	Main finishing tray (Tray 1), sub finishing tray (Tray 2)
Offset width	1-3/16
Paper types	Main finishing tray (Tray 2): Sort, group, sort and offset, group and offset: Plain paper (16 lb to 24 lb), thick paper (24-1/4 lb to 53-1/4 lb), thin paper (13-1/4 lb to 15-3/4 lb), label sheets, OHP transparencies, trace paper, tab paper, special paper, high-quality paper, user paper, recycled paper, colored paper, letterhead Staple: Plain paper (16 lb to 24 lb), recycled paper, high-quality paper, user paper, letterhead, special paper, thin paper, thick paper, colored paper Sub finishing tray (Tray 1): Sort, group: Plain paper (16 lb to 24 lb), thick paper (24-1/4 lb to 53-1/4 lb), thin paper (13-1/4 lb to 15-3/4 lb), label sheets, OHP transparencies, trace paper, tab paper











































Item	Description
Paper sizes	<p>Main finishing tray (Tray 2):</p> <p>Standard sizes: 11 × 17 to 5-1/2 × 8-1/2 *¹/, A3 to A5 *¹/, B6 *¹, Foolscap*², 8K , 16K /, wide paper (11 × 17W to 5-1/2 × 8-1/2W , A3W to A5W)</p> <p>Custom sizes: 7-3/16 × 5-13/16 to 12-3/8 × 18-1/16, 5-1/16 × 5-1/2*¹</p> <p>Sub finishing tray (Tray 1):</p> <p>Standard sizes: 11 × 17 to 5-1/2 × 8-1/2 /, A3 to A5 /, B6 , 13 × 19 , Foolscap*², 8K , 16K /, wide paper (11 × 17W to 5-1/2 × 8-1/2W /, A3W to A5W /)</p> <p>Custom sizes: 3-15/16 × 5-1/2 to 13-1/16 × 19-3/16</p> <p>Staple:</p> <p>Standard sizes: 11 × 17 to 5-1/2 × 8-1/2 , A3 to A5 , Foolscap*², 8K , 16K /, wide paper (11 × 17W to 5-1/2 × 8-1/2W , A3W to A5W)</p> <p>Custom sizes: 7-3/16 × 5-1/2 to 12-3/8 × 18-1/16</p>
Output tray capacity	<p>Main finishing tray (Tray 2):</p> <p>11 × 17, 8-1/2 × 14 : 1500 sheets 7-1/4 × 10-1/2, 8-1/2 × 11 : 3000 sheets 5-1/2 × 8-1/2 : 500 sheets</p> <p>Sub finishing tray (Tray 1): 200 sheets</p>
Staple settings	Maximum number of bound sheets: 50 sheets (16 lb to 24 lb)
Punch settings	Uses the optional punch settings.
Power requirements	Supplied from main unit
Maximum power consumption	80 W or less
Dimensions	26-3/4 (31-1/2 when trays are pulled out) (W) × 25-3/4 (D) × 39 (H)
Weight	132-1/4 lb
Consumables	Staple cartridge

*¹ Cannot be used with Finishing settings.





*² Foolscap includes the following 4 types: 8-1/8 × 13-1/4 , 8-1/4 × 13 , 8-1/2 × 13 , 8 × 13 , one of which can be selected. For details, contact the service representative.

5.2.4 Finisher FS-525

Item	Description
Name	FS-525
Function	<p>Straight delivery (sorted, grouped)</p> <p>Offset delivery (sort and offset, group and offset)</p> <p>Staple delivery</p>
Output trays	Main finishing tray (Tray 2), sub finishing tray (Tray 1)
Offset width	1-3/16
Paper types	<p>Main finishing tray (Tray 2):</p> <p>Sort, group, sort and offset, group and offset: Plain paper (16 lb to 24 lb), thick paper (24-1/4 lb to 53-1/4 lb), thin paper (13-1/4 lb to 15-3/4 lb), label sheets, OHP transparencies, trace paper, tab paper, special paper, high-quality paper, user paper, recycled paper, colored paper, letterhead</p> <p>Staple: Plain paper (16 to 21-1/4 lb), recycled paper, high-quality paper, user paper, letterhead, special paper, thin paper, thick paper, colored paper</p> <p>Sub finishing tray (Tray 1):</p> <p>Sort, group: Plain paper (16 lb to 24 lb), thick paper (24-1/4 lb to 53-1/4 lb), thin paper (13-1/4 lb to 15-3/4 lb), label sheets, OHP transparencies, trace paper, tab paper</p>

Item	Description
Paper sizes	<p>Main finishing tray (Tray 2):</p> <p>Standard sizes: 11 × 17  to 5-1/2 × 8-1/2 ^{*1}/, A3  to A5 ^{*1}/, B6 ^{*1}, Foolscap^{*2}, 8K , 16K , wide paper (11 × 17W  to 5-1/2 × 8-1/2W , A3W  to A5W )</p> <p>Custom sizes: 7-3/16 × 5-13/16 to 12-3/8 × 18-1/16, 5-1/16 × 5-1/2^{*1}</p> <p>Sub finishing tray (Tray 1):</p> <p>Standard sizes: 11 × 17  to 5-1/2 × 8-1/2 , A3  to A5 , B6 , 13 × 19 , Foolscap^{*2}, 8K , 16K , wide paper (11 × 17W  to 5-1/2 × 8-1/2W , A3W  to A5W )</p> <p>Custom sizes: 3-15/16 × 5-1/2 to 13-1/16 × 19-3/16</p> <p>Staple:</p> <p>Standard sizes: 11 × 17  to 5-1/2 × 8-1/2 , A3  to A5 , Foolscap^{*2}, 8K , 16K , wide paper (11 × 17W  to 5-1/2 × 8-1/2W , A3W  to A 5W )</p> <p>Custom sizes: 7-3/16 × 5-1/2 to 12-3/8 × 18-1/16</p>
Output tray capacity	<p>Main finishing tray (Tray 2):</p> <p>11 × 17, 8-1/2 × 14 : 1500 sheets 7-1/4 × 10-1/2, 8-1/2 × 11 : 3000 sheets 5-1/2 × 8-1/2 : 500 sheets</p> <p>Sub finishing tray (Tray 1): 200 sheets</p>
Staple settings	Maximum number of bound sheets: 100 sheets (16 lb to 21-1/4 lb)
Punch settings	Uses the optional punch settings.
Power requirements	Supplied from main unit
Maximum power consumption	80 W or less
Dimensions	26-3/4 (31-1/2) (W) × 25-3/4 (D) × 39 (H) The value in parentheses is the dimension when the tray is pulled out.
Weight	132-1/4 lb
Consumables	Staple cartridge

^{*1} Cannot be used with Finishing settings.

^{*2} Foolscap includes the following 4 types: 8-1/8 × 13-1/4 , 8-1/4 × 13 , 8-1/2 × 13 , 8 × 13 , one of which can be selected. For details, contact the service representative.

5.2.5 Finisher FS-610

Item	Description
Name	FS-610
Function	<p>Straight delivery (sorted, grouped)</p> <p>Offset delivery (sort and offset, group and offset)</p> <p>Staple, half-fold, center staple & fold, tri-fold</p>
Output trays	Main finishing tray (Tray 2), sub finishing tray (Tray 1), Booklet tray
Offset width	1-3/16
Paper types	<p>Main finishing tray (Tray 2):</p> <p>Sort, group, sort and offset, group and offset: Plain paper (16 lb to 24 lb), thick paper (24-1/4 lb to 53-1/4 lb), thin paper (13-1/4 lb to 15-3/4 lb), label sheets, OHP transparencies, trace paper, tab paper, special paper, high-quality paper, user paper, recycled paper, colored paper, letterhead</p> <p>Staple: Plain paper (16 lb to 21-1/4 lb), recycled paper, high-quality paper, user paper, letterhead, special paper, thin paper, thick paper, colored paper</p> <p>Sub finishing tray (Tray 1):</p> <p>Sort, group: Plain paper (16 lb to 24 lb), thick paper (24-1/4 lb to 53-1/4 lb), thin paper (13-1/4 lb to 15-3/4 lb), tab paper</p> <p>Booklet tray: Half-fold, tri-fold: Plain paper (16 lb to 24 lb)</p> <p>Center staple & fold: Plain paper (16 lb to 21-1/4 lb)</p>

Item	Description
Paper sizes	<p>Main finishing tray (Tray 2): Standard sizes: 11 × 17 to 5-1/2 × 8-1/2 *¹/, A3 to A5 *¹/, B6 *¹, Foolscap*², 8K , 16K /, wide paper (11 × 17W to 5-1/2 × 8-1/2W , A3W to A5W) Custom sizes: 7-3/16 × 5-13/16 to 12-3/8 × 18-1/16, 5-1/16 × 5-1/2*¹</p> <p>Sub finishing tray (Tray 1): Standard sizes: 13 × 19 , 12 × 18 to 5-1/2 × 8-1/2 /, A3 to A5 /, B6 , Foolscap*², 8K , 16K /, wide paper (11 × 17W to 5-1/2 × 8-1/2W /, A3W to A5W /) Custom sizes: 3-15/16 × 5-1/2 to 13-1/16 × 19-3/16</p> <p>Staple: Standard sizes: 11 × 17 to 5-1/2 × 8-1/2 , A3 to A5 , Foolscap*², 8K , 16K /, wide paper (11 × 17W to 5-1/2 × 8-1/2W , A3W to A5W) Custom sizes: 7-3/16 × 5-1/2 to 12-3/8 × 18-1/16</p> <p>Booklet tray: Standard sizes (Half-fold, center staple & fold): 11 × 17 , 8-1/2 × 14 , 8-1/2 × 11 , A3 , B4 , A4 , 8K , wide paper (11 × 17W , 8-1/2 × 11W , A3W , B4W , A4W) Standard sizes (Tri-fold): 8-1/2 × 11 , A4 , 16K Custom sizes (Half-fold, center staple & fold): 8-1/4 × 11 to 12-3/8 × 18-1/16</p>
Output tray capacity	<p>Main output tray (Tray 2): 11 × 17, 8-1/2 × 14 : 1500 sheets 7-1/4 × 10-1/2, 8-1/2 × 11 : 2500 sheets 5-1/2 × 8-1/2 : 500 sheets</p> <p>Sub output tray (Tray 1): 200 sheets</p> <p>Booklet tray: Half-fold (3 sheets): 25 - 33 sets Center staple & fold (5 sheets): 15 - 20 sets Tri-fold (1 sheet): 50 sets</p>
Staple settings	<p>Maximum number of bound sheets: 50 sheets (16 lb to 21-1/4 lb) Maximum number of sheets bound with center staple & fold: 20 sheets (16 lb to 21-1/4 lb)</p>
Punch settings	Uses the optional punch settings.
Power requirements	Supplied from main unit
Maximum power consumption	80 W or less
Dimensions	26-3/4 (31-1/2) (W) × 25-3/4 (D) × 39 (H) The value in parentheses is the dimension when the tray is pulled out.
Weight	143-1/4 lb
Consumables	Staple cartridge





*¹ Cannot be used with Finishing settings.

*² Foolscap includes the following 4 types: 8-1/8 × 13-1/4 , 8-1/4 × 13 , 8-1/2 × 13 , 8 × 13 , one of which can be selected. For details, contact the service representative.













5.2.6 Punch Kit PK-505

Item	Description
Name	PK-505
Function	Hole-punches for filing.
Number of holes	2 holes or 3 holes
Hole diameter	8.0 +/- 0.5 mm
Hole pitch	2-Hole: 70.0 +/- 0.5 mm 3-Hole: 108 +/- 0.5 mm
Paper types	Plain paper (16 lb to 24 lb), thick paper (24-1/4 lb to 34 lb)
Paper sizes	2 holes: 11 × 17 to 5-1/2 × 8-1/2 /, A3 to A5 , Foolscap* 3 holes: 11 × 17 , 8-1/2 × 11 , A3 to A4
Power requirements	Supplied from finisher





















Item	Description
Dimensions	5-3/4 (W) × 20 (D) × 4-3/4 (H)
Weight	Approx. 6-1/2 lb





* Foolscape includes the following 4 types: 8-1/8 × 13-1/4 , 8-1/4 × 13 , 8-1/2 × 13 , 8 × 13 , one of which can be selected. For details, contact the service representative.

5.2.7 Z Folding Unit ZU-605















Item	Description
Name	ZU-605
Function	Hole-punches for filing. Z-fold
Number of holes	2 holes or 3 holes
Hole diameter	8.0 +/- 0.5 mm
Hole pitch	2-Hole: 70.0 +/- 0.5 mm 3-Hole: 108 +/- 0.5 mm
Paper type for outputting hole-punched paper	Plain paper (16 lb to 24 lb), thin paper (13-1/4 lb to 15-3/4 lb)
Paper size for outputting hole-punched paper	2 holes: 11 × 17  , 8-1/2 × 14  , 8-1/2 × 11  /  , 7-1/4 × 10-1/2  /  , 5-1/2 × 8-1/2  /  3 holes: 11 × 17  , 8-1/2 × 11 
Fold type	Z-fold
Paper type for outputting z-folded paper	Plain paper (16 lb to 24 lb), thin paper (13-1/4 lb to 15-3/4 lb)
Paper size for outputting z-folded paper	11 × 17  , 8-1/2 × 14 
Power requirements	Supplied from main unit
Dimensions	6-3/4 (W) × 26 (D) × 36-1/2 (H)
Weight	Approx. 83-3/4 lb

5.2.8 Post Inserter PI-504





Item	Description
Name	PI-504
Configuration	2 (upper and lower) paper trays
Cover sheet type	Plain paper (16 lb to 24 lb), thick paper (24-1/4 lb to 53-1/4 lb), thin paper (13-1/4 lb to 15-3/4 lb)
Cover sheet size	Upper tray: Standard sizes: 8-1/2 × 11  /  to 5-1/2 × 8-1/2  , A4  to A5  , 16K  , wide paper (8-1/2 × 11W  /  to 5-1/2 × 8-1/2W  , A4W  to A5W  Custom sizes: 7-3/16 × 5-1/2 to 8-1/2 × 11-11/16 Lower tray: Standard sizes: 11 × 17  , 5-1/2 × 8-1/2  , A3  to A5  , Foolscape*, 8K  , 16K  , wide paper (11 × 17W  to 5-1/2 × 8-1/2W  , A3W  to A5W  Custom sizes: 7-3/16 × 5-1/2 to 12-3/8 × 18-1/16
Paper capacity	200 sheets for each of the upper and lower trays
Power requirements	Supplied from finisher
Maximum power consumption	30 W or less
Dimensions	20 (W) × 24-1/2 (D) × 8-3/4 (H)
Weight	Approx. 23-1/4 lb

* Foolscape includes the following 4 types: 8-1/8 × 13-1/4 , 8-1/4 × 13 , 8-1/2 × 13 , 8 × 13 , one of which can be selected. For details, contact the service representative.

5.2.9 Shift Tray SF-602

Item	Description
Name	SF-602
Function	Straight delivery (sorted, grouped) Offset stack (sort and offset, group and offset)
Amount of shift	1-3/16
Paper types	Plain paper (16 lb to 24 lb), thick paper (24-1/4 lb to 57-1/2 lb), thin paper (13-1/4 lb to 15-3/4 lb), OHP transparencies ^{*1} , trace paper ^{*1} , tab paper ^{*1}
Paper sizes	Standard sizes: 11 × 17  to 5-1/2 × 8-1/2  , 7-1/4 × 10-1/2  ^{*1} /  ^{*1} , A3  to A5  , B6  ^{*1} , Fools-cap ^{*2} , 8K  , 16K  Custom sizes: 4-1/8 × 5-1/2 to 12 × 18-1/16 ^{*1} , 5-1/2 × 5-1/2 to 12-3/8 × 18-1/16
Output tray capacity	8-1/2 × 11  /  : 1250 sheets 11 × 17  , 8-1/2 × 14  : 500 sheets 5-1/2 × 8-1/2  /  : 100 sheets
Power requirements	Supplied from main unit
Dimensions	15-3/4 (19-1/4) (W) × 23-1/2 (D) × 19 (H) The value in parentheses is the dimension when the tray is pulled out.
Weight	Approx. 30-3/4 lb

^{*1} Cannot be used with Finishing settings.

^{*2} Foolscap includes the following 4 types: 8-1/8 × 13-1/4 , 8-1/4 × 13 , 8-1/2 × 13 , 8 × 13 , one of which can be selected. For details, contact the service representative.

5.2.10 Output Tray OT-505

Item	Description
Name	OT-505
Function	Paper output tray for main unit
Paper types	Plain paper (16 lb to 24 lb), thick paper (24-1/4 lb to 53-1/4 lb), thin paper (13-1/4 lb to 15-3/4 lb), OHP transparencies, trace paper, tab paper
Output tray capacity	Max. 150 sheets
Dimensions	8-1/2 (13-1/4) (W) × 14-1/4 (D) × 2-3/4 (H) inch The value in parentheses is the dimension when the tray is pulled out.
Weight	Approx. 1-1/4 lb

5.2.11 Authentication Unit (Biometric Type) AU-101

Item		Description
Name		AU-101
Compatible finger width		10 mm to less than 25 mm
Interface		USB 2.0
Dimensions		Approx. 78 mm (W) × 95 mm (D) × 55 mm (H)
Weight		Approx. 150 g (not including the USB cable)
Power consumption		DC 5 V, 500 mA
Environment conditions (when operating)	Temperature	10 to 35 °C
	Humidity	10 to 80% (Must be no condensation)
Environment conditions (when not operating)	Temperature	-10 to 60 °C
	Humidity	10 to 80% (Must be no condensation)
Computer	Processor	PC/AT compatible, 1 GHz or more
	Memory	128 MB or more
	Hard disk drive	Available hard disk space: 100 MB or more
	Monitor	800 × 600 pixels, 16-bit color or more
	Network	TCP/IP protocol
	Application	Microsoft Internet Explorer 6.0 (Service Pack 1) or later Microsoft .NET Framework (Service Pack 1) or later
	Interface	USB 1.1 or later
Supported operating systems		Windows 2000 Professional (Service Pack 4) Windows XP Professional Edition (Service Pack 2) Windows Vista Business/Enterprise

5.2.12 Authentication Unit (IC Card Type) AU-201

Item		Description
Name		AU-201
Dimensions		Approx. 92 mm (W) × 64 mm (D) × 16 mm (H)
Weight		Approx. 120 g
Power requirements		Through USB port
Environment conditions (when operating)	Temperature	0 to 40 °C
	Humidity	20 to 85% (Must be no condensation)
Environment conditions (when not operating)	Temperature	-20 to 50 °C
	Humidity	20 to 85% (Must be no condensation)
Radio waves classification		Induced reading/writing communication equipment
Compatible card Processor		Contactless IC card compliant with ISO 14443 Type A and FeliCa
Computer	Processor	PC/AT compatible, 1 GHz or more
	Memory	128 MB or more
	Hard disk drive	Available hard disk space: 100 MB or more
	Monitor	800 × 600 pixels, 16-bit color or more
	Network	TCP/IP protocol
	Application	Microsoft Internet Explorer 6.0 (Service Pack 1) or later Microsoft .NET Framework (Service Pack 1) or later
	Interface	USB 1.1 or later
Supported operating systems		Windows 2000 Professional (Service Pack 4) Windows XP Professional Edition (Service Pack 2)

5.2.13 Other Options

Image Controller IC-208

Mount Kit MK-716

Fax Kit FK-502

Hard Disk HD-510

Staple Kit SK-602

Staple MS-10A

Staple MS-5C

Key Counter Kit

Key Counter Socket

Security Kit SC-506

Working Table WT-504

Local Interface Kit EK-703

6

Copy paper/originals

6 Copy paper/originals

6.1 Copy paper

Available paper size/type is restricted in each equipment.

6.1.1 Paper Tray and Equipment

This machine is equipped with the following trays for loading copy paper.

- Main unit trays: Tray 1, 2, 3 and 4
- Bypass tray
- Large Capacity Unit LU-405/406

Also, the following equipment is provided for conveying/delivering copies.

- ADU (Automatic Duplex Unit) (built in to the main unit)
- Finisher FS-524 (built-in staple unit)
- Finisher FS-525 (built-in staple unit)
- Finisher FS-610 (built-in staple unit and folding unit)
- Punch Kit PK-505 (for Finisher FS-524/525/610)
- Z Folding Unit ZU-605 (built-in punch kit)
- Post Inserter PI-504 (for Finisher FS-524/525/610)
- Shift Tray SF-602 (for the machine without finisher)
- Output Tray OT-505 (for the machine without finisher)





6.1.2 Paper Weight

Paper trays	Paper Weight
Main unit trays (Tray 1, 2, 3 and 4)	16 lb to 24 lb Select "thick paper" when loading 24-1/4 lb to 53-1/4 lb paper. Select "thin paper" when loading 13-1/4 lb to 15-3/4 lb paper.
Large Capacity Unit LU-405	
Large Capacity Unit LU-406	
Bypass tray	
Post Inserter PI-504	

























































































Equipment	Paper Weight
Automatic Duplex Unit	16 lb to 53-1/4 lb
Finisher FS-524 + Punch Kit PK-505	Sort, group: 13-1/4 lb to 53-1/4 lb Sort and offset, group and offset: 13-1/4 lb to 53-1/4 lb Staple: 16 lb to 24 lb Punch: 16 lb to 34 lb
Finisher FS-525 + Punch Kit PK-505	Sort, group: 13-1/4 lb to 53-1/4 lb Sort and offset, group and offset: 13-1/4 lb to 53-1/4 lb Staple: 16 lb to 21-1/4 lb Punch: 16 lb to 34 lb
Finisher FS-610 + Punch Kit PK-505	Sort, group: 13-1/4 lb to 53-1/4 lb Sort and offset, group and offset: 13-1/4 lb to 53-1/4 lb Staple: 16 lb to 21-1/4 lb Half-fold, Tri-fold: 16 lb to 24 lb Center staple & fold: 16 lb to 21-1/4 lb Punch: 16 lb to 34 lb
Z Folding Unit ZU-605	Z-fold: 13-1/4 lb to 24 lb
Shift Tray SF-602	13-1/4 lb to 57-1/2 lb
Output Tray OT-505	13-1/4 lb to 53-1/4 lb





6.1.3 Paper Tray/ Output Tray Capacity









































































Paper trays	Capacity
Main unit paper tray (Tray 1)	1500 sheets (21-1/4 lb)
Main unit paper tray (Tray 2)	1000 sheets (21-1/4 lb)
Main unit paper tray (Tray 3/4)	500 sheets (21-1/4 lb)
Large Capacity Unit LU-405	4000 sheets (20 lb)
Large Capacity Unit LU-406	4000 sheets (20 lb)
Bypass tray	Plain paper: 100 sheets (21-1/4 lb) Special paper: 1 sheet
Post Inserter PI-504	200 sheets (21-1/4 lb)

































































































































Equipment	Capacity
Automatic Duplex Unit	Unlimited
Finisher FS-524	Main finishing tray (Tray 2): 11 × 17, 8-1/2 × 14 : 1500 sheets (21-1/4 lb) 7-1/4 × 10-1/2, 8-1/2 × 11 : 3000 sheets (21-1/4 lb) 5-1/2 × 8-1/2 : 500 sheets (21-1/4 lb) Staple: 150 to 20 sets (16 lb to 24 lb) Sub finishing tray (Tray 1): 200 sheets (21-1/4 lb)
Finisher FS-525	Main finishing tray (Tray 2): 11 × 17, 8-1/2 × 14 : 1500 sheets (21-1/4 lb) 7-1/4 × 10-1/2, 8-1/2 × 11 : 3000 sheets (21-1/4 lb) 5-1/2 × 8-1/2 : 500 sheets (21-1/4 lb) Staple: 150 to 10 sets (16 lb to 24-1/4 lb) Sub finishing tray (Tray 1): 200 sheets (24-1/4 lb)
Finisher FS-610	Main finishing tray (Tray 2): 11 × 17, 8-1/2 × 14 : 1500 sheets (21-1/4 lb) 7-1/4 × 10-1/2, 8-1/2 × 11 : 2500 sheets (21-1/4 lb) 5-1/2 × 8-1/2 : 500 sheets (21-1/4 lb) Staple: 100 to 20 sets (16 lb to 24-1/4 lb) Sub finishing tray (Tray 1): 200 sheets (21-1/4 lb) Booklet tray: Half-fold (tri-fold): 25 to 33 sets (21-1/4 lb) Center staple & fold (5 sheets): 15 to 20 sets (21-1/4 lb) Tri-fold (1 sheet): 50 sets (21-1/4 lb)
Shift Tray SF-602	8-1/2 × 11  : 1250 sheets (21-1/4 lb) 11 × 17  8-1/2 × 14  : 500 sheets (21-1/4 lb) 5-1/2 × 8-1/2  : 100 sheets (21-1/4 lb)
Output Tray OT-505	150 sheets (21-1/4 lb)

6.1.4 Paper Size





Paper Trays	Available Size
Main unit paper tray (Tray 1/2)	8-1/2 × 11  , 5-1/2 × 8-1/2  , A4  , B5  , A5 
Main unit paper tray (Tray 3/4)	Standard sizes: 11 × 17  , 8-1/2 × 14  , 8-1/2 × 11   , 5-1/2 × 8-1/2  , A3  , B4  , A4  , B5   , Foolscap*, wide paper (11 × 17W  , 8-1/2 × 11W   , 5-1/2 × 8-1/2W  , A3W  , B4W  , A4W  , B5W  ) Custom sizes: 7-3/16 × 5-1/2 to 12-3/8 × 18-1/16
Large Capacity Unit LU-405	Standard sizes: 8-1/2 × 11  , A4  , 16K 
Large Capacity Unit LU-406	Standard sizes: 11 × 17  , 8-1/2 × 14  , 8-1/2 × 11   , A3  , B4  , A4   , Foolscap*, 8K  , 16K 
Bypass tray	Standard sizes: 11 × 17  , 8-1/2 × 14  , 8-1/2 × 11   , 5-1/2 × 8-1/2   , A3  , B4  , A4   , B5   , wide paper (11 × 17W  , 8-1/2 × 11W   , 5-1/2 × 8-1/2W   , A3W  , B4W  , A4W   , B5W  ) Custom sizes: 3-15/16 × 5-1/2 to 12-3/8 × 18-1/16
Post Inserter PI-504	Upper tray: Standard sizes: 8-1/2 × 11   , 5-1/2 × 8-1/2  , A4   , 16K   , wide paper (8-1/2 × 11W   , 5-1/2 × 8-1/2W   , A4W   , to A5W  ) Custom sizes: 7-3/16 × 5-1/2 to 8-1/2 × 11-11/16 Lower tray: Standard sizes: 11 × 17  to 5-1/2 × 8-1/2  , A3  to A5  , Foolscap*, 8K  , 16K   , wide paper (11 × 17W   , 5-1/2 × 8-1/2W   , A3W   , to A5W  ) Custom sizes: 7-3/16 × 5-1/2 to 12-3/8 × 18-1/16

* Foolscap includes the following 4 types: 8-1/8 × 13-1/4 , 8-1/4 × 13 , 8-1/2 × 13 , 8 × 13 , one of which can be selected. For details, contact the service representative.

Equipment	Available Size
Automatic Duplex Unit	Standard sizes: 11 × 17  to 5-1/2 × 8-1/2   , A3  to A5   , B6  , A6  , Foolscap* ² , 8K  , 16K   wide paper (11 × 17W   , to 5-1/2 × 8-1/2W   , A3W   , to A5W  ) Custom sizes: 4-1/8 × 5-1/2 to 12-3/8 × 18-1/16
Finisher FS-524	Main finishing tray (Tray 2): Standard sizes: 11 × 17  to 5-1/2 × 8-1/2   ¹ /  , A3  to A5   ¹ /  , B6  ¹ /  , Foolscap* ² , 8K  , 16K   wide paper (11 × 17W   , to 5-1/2 × 8-1/2W   , A3W   , to A5W  ) Custom sizes: 7-3/16 × 5-13/16 to 12-3/8 × 18-1/16, 5-1/16 × 5-1/2 ¹ Sub finishing tray (Tray 1): Standard sizes: 11 × 17  to 5-1/2 × 8-1/2   , A3  to A5   , B6  , Foolscap* ² , 8K  , 16K   wide paper (11 × 17W   , to 5-1/2 × 8-1/2W   , A3W   , to A5W  ) Custom sizes: 3-15/16 × 5-1/2 to 13-1/16 × 19-3/16 Staple: Standard sizes: 11 × 17  to 5-1/2 × 8-1/2  , A3  to A5  , Foolscap* ² , 8K  , 16K   wide paper (11 × 17W   , to 5-1/2 × 8-1/2W   , A3W   , to A5W  ) Custom sizes: 7-3/16 × 5-1/2 to 12-3/8 × 18-1/16

Equipment	Available Size
Finisher FS-525	<p>Main finishing tray (Tray 2): Standard sizes: 11 × 17  to 5-1/2 × 8-1/2 ^{*1}/, A3  to A5 ^{*1}/, B6 ^{*1}, Foolscap^{*2}, 8K , 16K  wide paper (11 × 17W  to 5-1/2 × 8-1/2W , A3W  to A5W ) Custom sizes: 7-3/16 × 5-13/16 to 12-3/8 × 18-1/16, 5-1/16 × 5-1/2^{*1} Sub finishing tray (Tray 1): Standard sizes: 11 × 17  to 5-1/2 × 8-1/2 , A3  to A5 , B6 , Foolscap^{*2}, 8K , 16K  wide paper (11 × 17W  to 5-1/2 × 8-1/2W , A3W  to A5W  Custom sizes: 3-15/16 × 5-1/2 to 13-1/16 × 19-3/16 Staple: Standard sizes: 11 × 17  to 5-1/2 × 8-1/2 , A3  to A5 , Foolscap^{*2}, 8K , 16K  wide paper (11 × 17W  to 5-1/2 × 8-1/2W , A3W  to A5W  Custom sizes: 7-3/16 × 5-1/2 to 12-3/8 × 18-1/16</p>
Finisher FS-610	<p>Main finishing tray (Tray 2): Standard sizes: 11 × 17  to 5-1/2 × 8-1/2 ^{*1}/, A3  to A5 ^{*1}/, B6 ^{*1}, Foolscap^{*2}, 8K , 16K  wide paper (11 × 17W  to 5-1/2 × 8-1/2W , A3W  to A5W ) Custom sizes: 7-3/16 × 5-13/16 to 12-3/8 × 18-1/16, 5-1/16 × 5-1/2^{*1} Sub finishing tray (Tray 1): Standard sizes: 13 × 19 , 12 × 18  to 5-1/2 × 8-1/2 , A3  to A5 , B6 , Foolscap^{*2}, 8K  16K , wide paper (11 × 17W  to 5-1/2 × 8-1/2W , A3W  to A5W  Custom sizes: 3-15/16 × 5-1/2 to 13-1/16 × 19-3/16 Staple: Standard sizes: 11 × 17  to 5-1/2 × 8-1/2 , Foolscap^{*2}, 8K , 16K  A3  to A5  wide paper (11 × 17W  to 5-1/2 × 8-1/2W , A3W  to A5W  Custom sizes: 7-3/16 × 5-1/2 to 12-3/8 × 18-1/16 Booklet tray: Standard sizes (Half-fold, center staple & fold): 11 × 17 , 8-1/2 × 14 , 8-1/2 × 11 , 8K , A3 , B4 , A4 , wide paper (11 × 17W , 8-1/2 × 11W , A3W , B4W , A4W  Standard sizes (Tri-fold): A4 , 8-1/2 × 11 , 16K Custom sizes (Half-fold, center staple & fold): 8-1/4 × 11 to 12-3/8 × 18-1/16</p>
Shift Tray SF-602	<p>Standard sizes: 11 × 17  to 5-1/2 × 8-1/2 , 7-1/4 × 10-1/2 ^{*1}/^{*1}, A3  to A5 , B6 ^{*1}. Foolscap^{*2}, 8K , 16K  Custom sizes: 4-1/8 × 5-1/2 to 12 × 18-1/16^{*1}, 5-1/2 × 5-1/2 to 12-3/8 × 18-1/16</p>
Output Tray OT-505	<p>Standard sizes: 11 × 17 , 8-1/2 × 14 , 8-1/2 × 11 , 5-1/2 × 8-1/2 , A3 , B4 , A4 , B5  wide paper (11 × 17W , 8-1/2 × 11W , 5-1/2 × 8-1/2W , A3W , B4W , A4W  B5W  Custom sizes: 3-15/16 × 5-1/2 to 12-3/8 × 18-1/16</p>

^{*1} Cannot be used with Finishing settings.

^{*2} Foolscap includes the following 4 types: 8-1/8 × 13-1/4 , 8-1/4 × 13 , 8-1/2 × 13 , 8 × 13 , one of which can be selected. For details, contact the service representative.









6.1.5 Special Paper





When loading the paper except normal (overhead projection transparent film, thick paper, colored paper etc.), select the appropriate name from 10. A paper tray with this setting is not automatically selected when the Auto Paper Select setting is specified or when the paper trays are switched automatically.

Available paper types depend on the paper tray.

For details on the paper setting for bypass tray, see ["Specifying a paper type for bypass tray" on page 6-18.](#)

For details on paper type setting for ["Paper type setting for a tray" on page 6-20.](#)

No.	Paper type/Icon	Description
1	OHP 	Select this setting when overhead projection transparent films are loaded.
2	Special Paper 	Select this setting when special paper, for example, high-quality paper, is loaded as plain paper with a weight of 16 lb to 24 lb.
3	Thick Paper 	Select this setting when the thick paper that is loaded has a weight to 24 lb to 53 lb.
4	Thin Paper 	Select this setting when the Thin paper that is loaded has a weight of 13 lb to 15 lb.
5	Letterhead 	Select this setting when plain paper that is loaded has a weight of 16 lb to 24 lb and is already printed with a company name or preset text.
6	Colored Paper 	Select this setting when plain colored paper weighing from 16 lb to 24 lb is loaded.
7	Tab Paper 1 	Select this setting when tab paper is loaded.
8	Trace Paper 	Select this setting when trace paper is loaded.
9	User Paper 1 	Select this setting when paper that is loaded has a weight of 16 lb to 24 lb and does not match with any other paper type. For details, contact your service representative.

No.	Paper type/Icon	Description
10	User Paper 2 	Select this setting when paper that is loaded has a weight of 16 lb to 24 lb and does not match with any other paper type. For details, contact your service representative.
11	User Paper 3 	Select this setting when paper that is loaded has a weight of 16 lb to 24 lb and does not match with any other paper type. For details, contact your service representative.
12	Recycled 	Select this setting when using recycled paper.
13	Fine 	Select this setting when high-quality paper is loaded.
14	Labels 	Select this setting when label sheets are loaded.

6.1.6 Precautions for paper

Do not use the following types of paper.

Otherwise, decreased print quality, paper misfeeds or damage may result.

- OHP transparencies that have already been fed through the machine (even if the transparency is still blank)
- Paper that has been printed on with a heat-transfer printer or an inkjet printer
- Paper that is either extremely thick or extremely thin
- Folded, curled, wrinkled, or torn paper
- Paper that has been left unwrapped for a long period of time
- Damp paper, perforated paper, or paper with punched holes
- Extremely smooth or extremely rough paper, or paper with an uneven surface
- Paper that has been treated, such as carbon-backed, heat-sensitive or pressure-sensitive paper
- Paper that has been decorated with foil or embossing
- Paper of a non-standard shape (not rectangular)
- Paper that is bound with glue, staples or paper clips
- Paper with labels attached
- Paper with ribbons, hooks, buttons, etc., attached

6.1.7 Paper storage

Store paper in a cool, dark location with little humidity.

If the paper becomes damp, paper misfeeds may occur.

Paper that has not been loaded should be kept wrapped or placed in a plastic bag and stored in a cool, dark location with little humidity.

Store the paper laying flat, not standing on its edge. Curled paper may cause paper misfeeds.

Keep paper out of the reach of children.

6.1.8 Auto Tray Switch Function

If the selected paper tray runs out of paper while a job is being printed and a different paper tray is loaded with paper meeting the following conditions, the other paper tray is automatically selected so printing can continue. If the optional large capacity unit LU-203 is installed, a maximum of 5,650 copies can be made continuously. (The paper tray is automatically switched only if the "ATS Permission parameter" in the Utility mode is set to "Permit".)

Operating Conditions (Set the following condition at "1 System Setting>3 Paper Tray Setting" of User Setting.)

- Select the paper trays to be selected automatically by "Auto Tray Select Setting", if Auto paper select is functioned.
Tray Priority is available.
- Select "Allow" at "Auto Tray Switch ON/OFF"
- Select the same paper type at "Paper Type".

Load the following paper into the paper trays.

- The same size in the same orientation.
- The same paper type.

6.2 Selecting the Paper settings for bypass tray

This section describes the procedures for specifying the size and type of paper loaded in bypass tray.



Detail

For details on loading the paper into the bypass tray, refer to ["Loading paper into the bypass tray" on page 1-53](#).

6.2.1 Automatically detecting the paper size ("Auto Detect" setting)

The size of the paper loaded into bypass tray can be detected automatically.

- 1 In the Basic screen, touch [Paper].

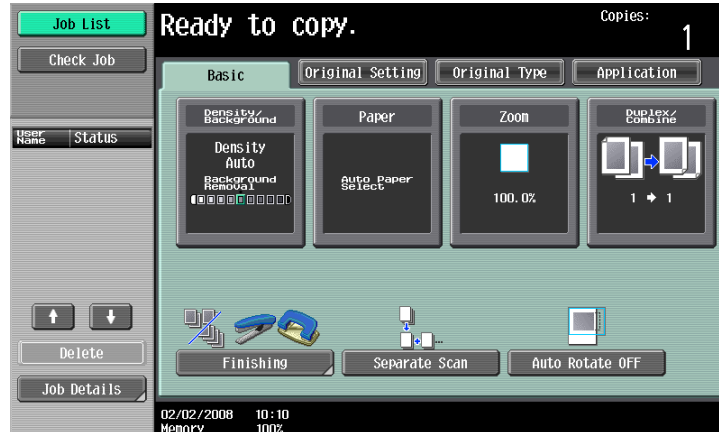

The Paper screen appears.

- 2 Touch the button for bypass tray.



- 3 Touch [Change Tray Settings].

- 4 Touch [Auto Detect].

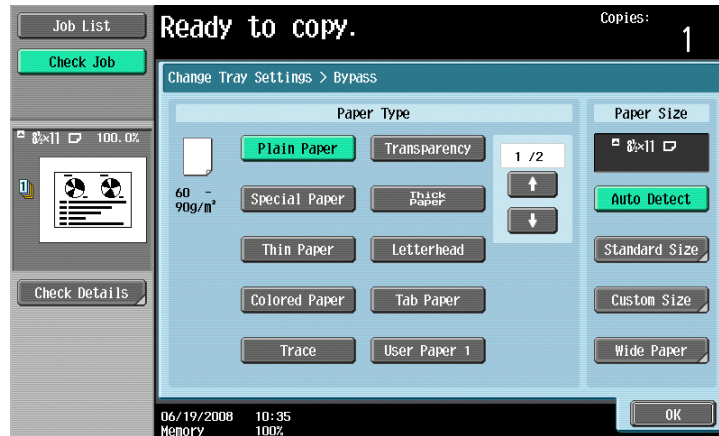

As the factory default, "Auto Detect" is selected.

- 5 Touch [OK], and then touch [OK] in the next screen that appears.
The Basic screen appears again.

6.2.2 Selecting a paper size setting (Size Setting)

The paper size can be set for the bypass tray so that it can be used with the specified paper size.

This is useful, for example, when the size of the paper that is loaded cannot be automatically detected (such as with paper in metric sizes).

The following procedure describes how to specify the setting for A4  loaded into the bypass tray.

- 1 In the Basic screen, touch [Paper].

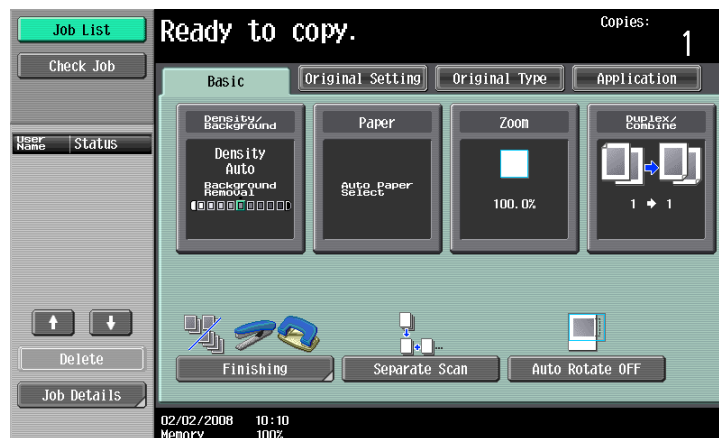

The Paper screen appears.

- 2 Select the button for the bypass tray.

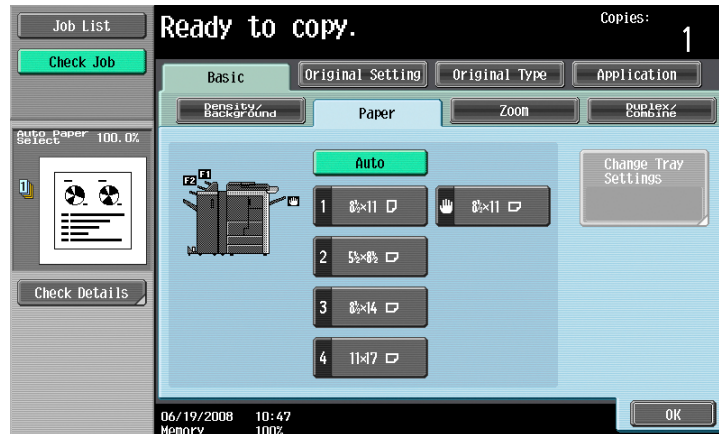

- 3 Touch [Change Tray Settings].

- 4 Touch [Standard Size].

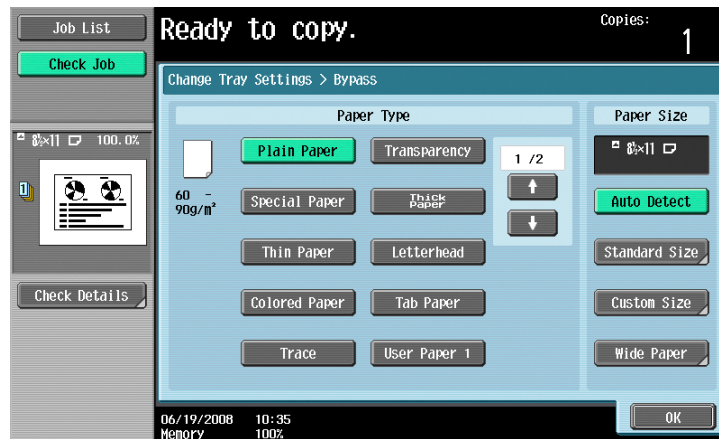

The Standard Size screen appears.

- 5 Touch [A4].



- 6 Touch [OK], and then touch [OK] in the next two screens that appear.

The Basic screen appears again.
The paper size for the bypass tray is set.



Reminder

If paper other than the specified paper size is loaded, a paper misfeed may occur since the paper size is not automatically detected.

6.2.3 Specifying a non-standard paper size (Custom Size settings)

If paper other than standard-size paper is loaded into the bypass tray, it will be necessary to enter the paper size.

- 1 In the Basic screen, touch [Paper].

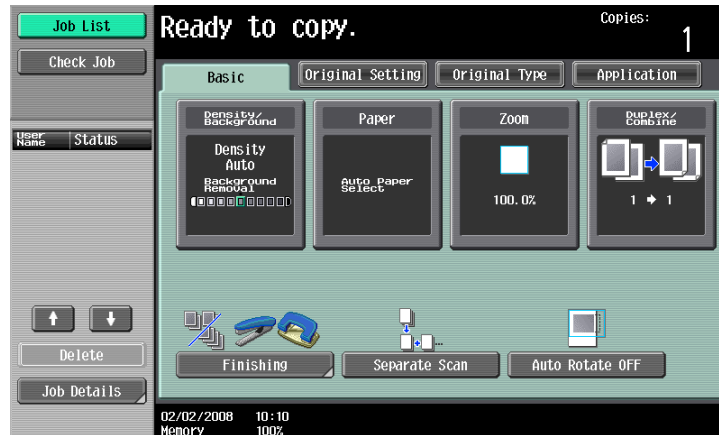

The Paper screen appears.

- 2 Select the button for the bypass tray.



- 3 Touch [Change Tray Settings].

4 Touch [Custom Size].

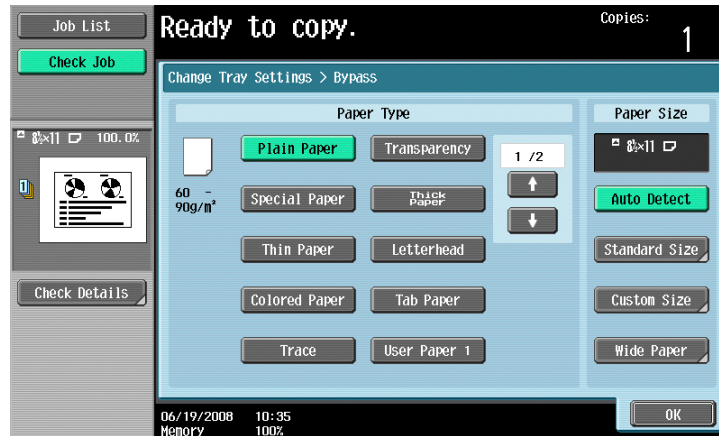

The Custom Size screen appears.

5 Type in the length (X) and width (Y) of the paper.

- Make sure that [X] is selected, touch [↔] to switch between the integer and the fraction, and then touch [-] and [+] to type in the length of side X. (5-1/2 inch to 18 inch)
- Make sure that [Y] is selected, touch [↔] to switch between the integer and the fraction, and then touch [-] and [+] to type in the length of side Y. (3-15/16 inch to 12-5/16 inch)
- If a decimal value is displayed in the Custom Size screen, use the keypad to type in the setting. For details on switching between decimal and fraction values, refer to ["System Settings" on page 11-15](#).
- If a decimal value is displayed in the screen and the specified value is outside the allowable range, the message "Input Error" appears. Type a value within the allowable range. If the value was incorrectly entered, press the [C] (clear) key to erase the value, and then specify the correct value.

To cancel changes to the settings, touch [Cancel].

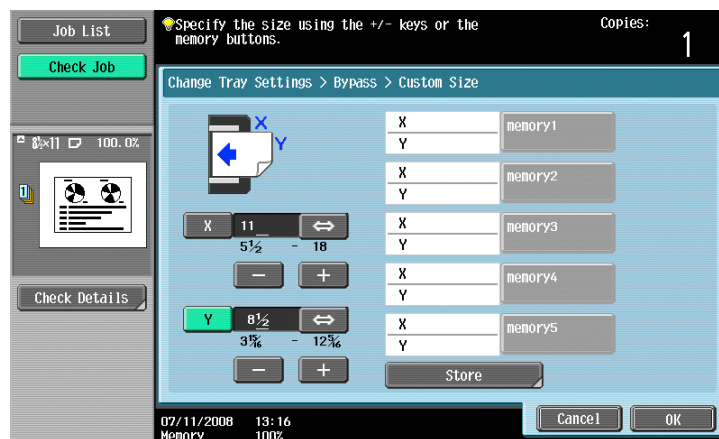

? Can paper sizes be stored?

→ Five non-standard paper sizes can be stored.

→ To recall a stored paper size, touch the corresponding memory key.

→ The names "memory1" through "memory5" can be changed. For details on changing the names, refer to ["Storing a non-standard paper size \(Custom Size settings\)" on page 6-14](#).

→ For details on storing paper sizes, refer to ["Storing a non-standard paper size \(Custom Size settings\)" on page 6-14](#).

6 Touch [OK], and then touch [OK] in the next two screens that appear.

The Basic screen appears again.

6.2.4 Storing a non-standard paper size (Custom Size settings)

Five non-standard paper sizes can be stored.

Storing paper sizes that are used often allows the paper size to be quickly selected, without having to re-enter the setting.

- 1 In the Basic screen, touch [Paper].

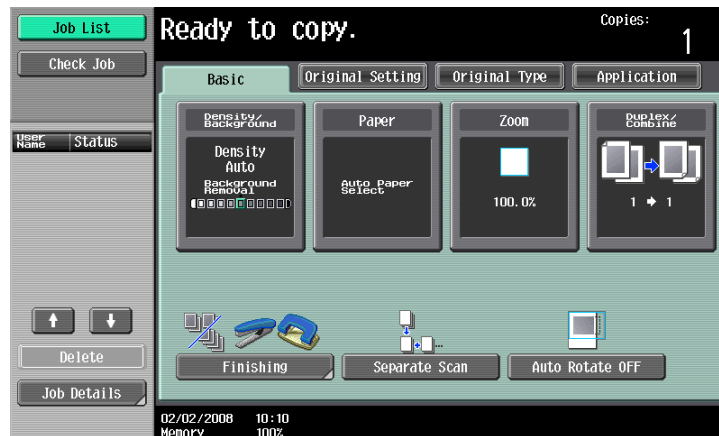

The Paper screen appears.

- 2 Select the button for the bypass tray.



- 3 Touch [Change Tray Settings].

- 4 Touch [Custom Size].

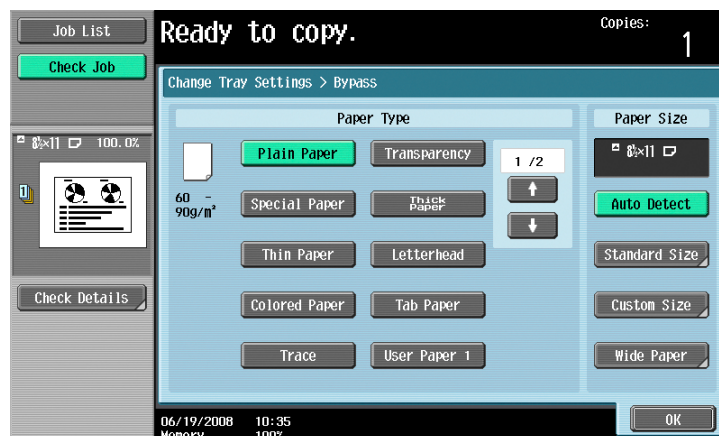

The Custom Size screen appears.

- 5 Specify the X and Y sides of the paper, and then touch [Store].

- Make sure that [X] is selected, touch [\leftrightarrow] to switch between the integer and the fraction, and then touch [-] and [+] to type in the length of side X. (5-1/2 inch to 18 inch)
- Make sure that [Y] is selected, touch [\leftrightarrow] to switch between the integer and the fraction, and then touch [-] and [+] to type in the length of side Y. (3-15/16 inch to 12-5/16 inch)
- If a decimal value is displayed in the Custom Size screen, use the keypad to type in the setting. For details on switching between decimal and fraction values, refer to **"System Settings" on page 11-15**.
- If a decimal value is displayed in the screen and the specified value is outside the allowable range, the message "Input Error" appears. Type a value within the allowable range. If the value was incorrectly entered, press the [C] (clear) key to erase the value, and then specify the correct value. To cancel changes to the settings, touch [Cancel].

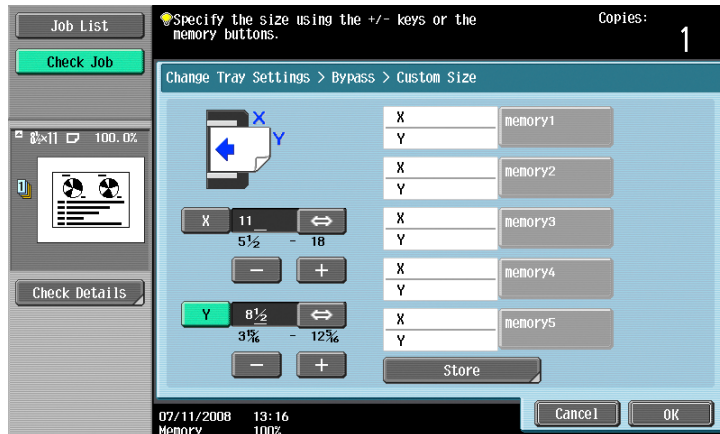

- 6 Touch the memory button where the paper size is to be stored.

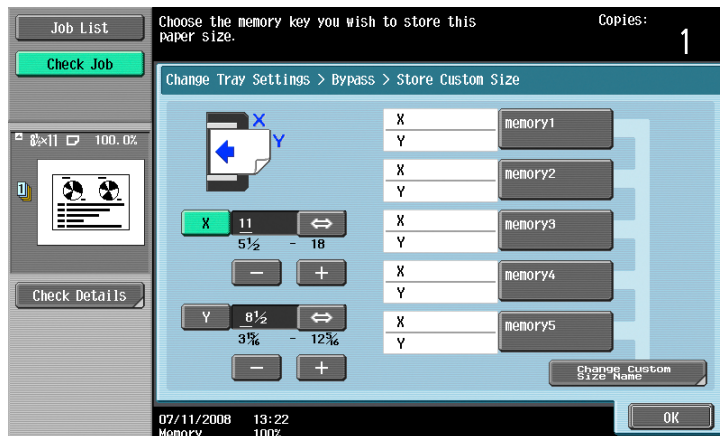

- To change the name of a memory key, touch [Change Custom Size Name], and then touch the key to be renamed.

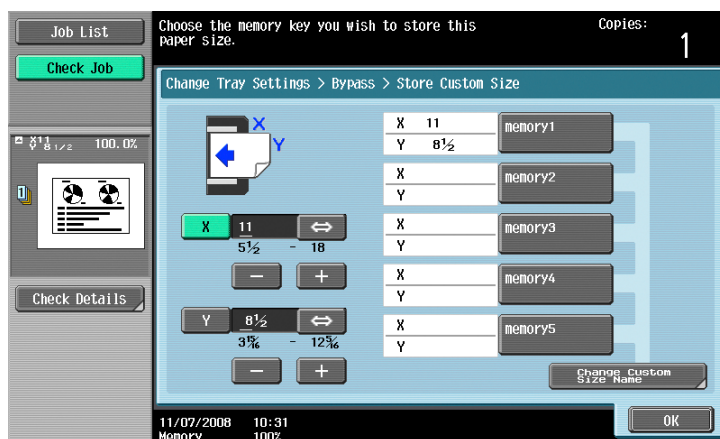

Using the keyboard that appears, type in the name of the key, touch [OK], and then touch [Close]. For details on typing in text, refer to ["Entering text" on page 14-2](#).

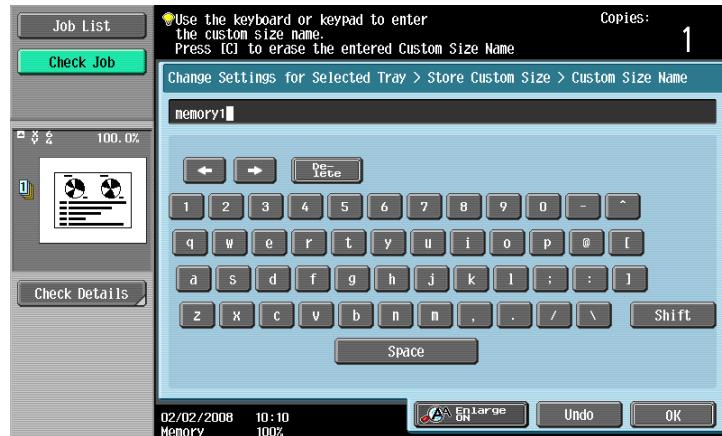

- 7 Touch [OK], and then touch [OK] in the next three screens that appear.
The Basic screen appears again.

6.2.5 Selecting a setting for oversized paper (Wide Paper settings)

If paper one size larger than a standard size is being used in the bypass tray, specify a setting for wide paper.



Detail

By specifying paper one size larger than the document as wide paper, the document can be copied at the center so that there is no loss of the document image.

When specifying wide paper for the bypass tray, non-standard-sized paper can be specified. When using non-standard-sized paper, enter the paper size.

For details on the setting for tray 3 and tray 4, refer to ["To select a setting for oversized paper" on page 6-25](#)

For details on loading the paper into the bypass tray, refer to ["Loading paper into the bypass tray" on page 1-53](#).

The following procedure describes how to specify the setting for wide paper loaded into the bypass tray.

- 1 In the Basic screen, touch [Paper].

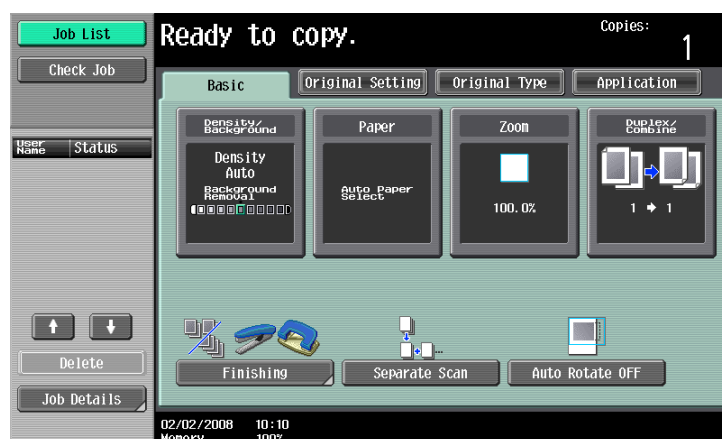

The Paper screen appears.

- 2 Touch the button for the bypass tray.

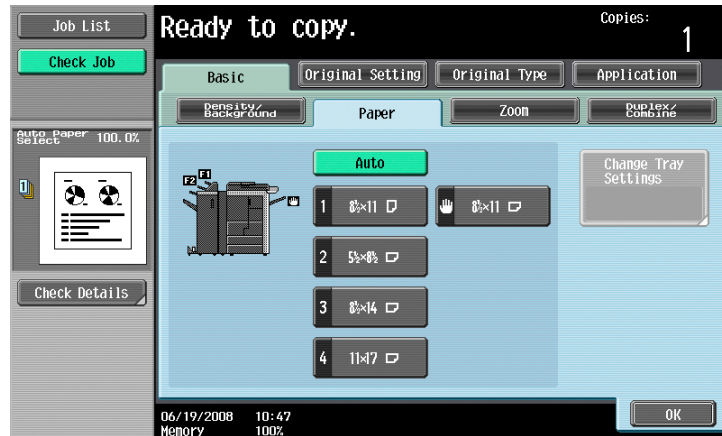

- 3 Touch [Change Tray Settings].

- 4 Touch [Wide Paper].

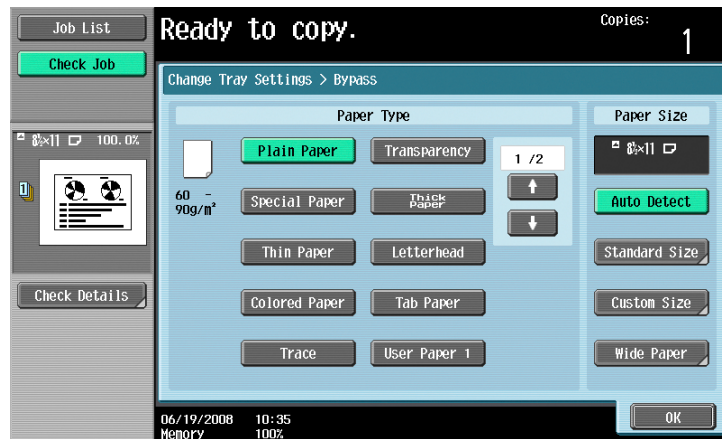

The Wide Paper screen appears.

- 5 Select the size of the paper to be loaded.
- Touch [↑] and [↓] until the button for the desired paper size is displayed.

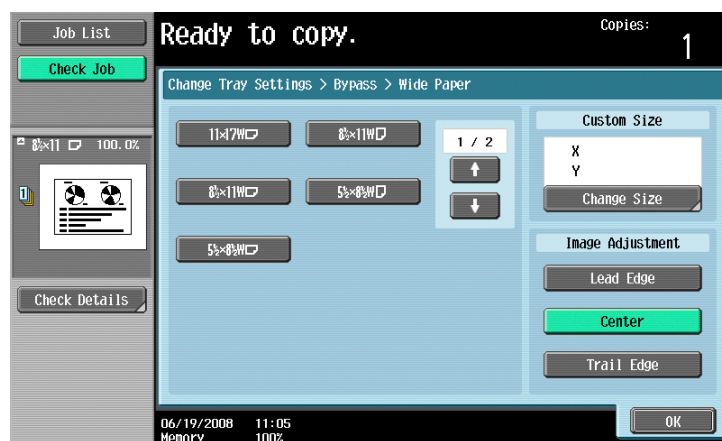

- 6 To change the size, touch [Change Size].
- The Change Size screen for oversized paper appears.

- 7 Specify the X and Y sides of the paper, and then touch [OK].
- Touch either [X] or [Y], press the [C] (clear) key to clear the current setting, and then use the keypad to type in the size.
 - If a decimal value is displayed in the Custom Size screen, use the keypad to type in the setting. For details on switching between decimal and fraction values, refer to ["System Settings" on page 11-15](#).
 - If the orientation of the loaded paper does not match the sizes specified for "X" and "Y", "Input error" appears, even if the values are within the allowable range. In addition, do not enter the same size for "X" and "Y".
 - If a decimal value is displayed in the screen and the specified value is outside the allowable range, the message "Input Error" appears. Type a value within the allowable range. If the value was incorrectly entered, press the [C] (clear) key to erase the value, and then specify the correct value.
- To cancel changes to the settings, touch [Cancel].



- 8 Touch [OK], and then touch [OK] in the next two screens that appear.
The Basic screen appears again.



Note

The selected size button is programmed with the entered paper size, so that the paper size is available to be selected again without being typed in. In addition, the size can be changed.

6.2.6 Specifying a paper type for bypass tray

If paper other than plain paper, such as OHP transparencies or special paper, is loaded in bypass tray, be sure to change the paper type setting.

- 1 In the Basic screen, touch [Paper].

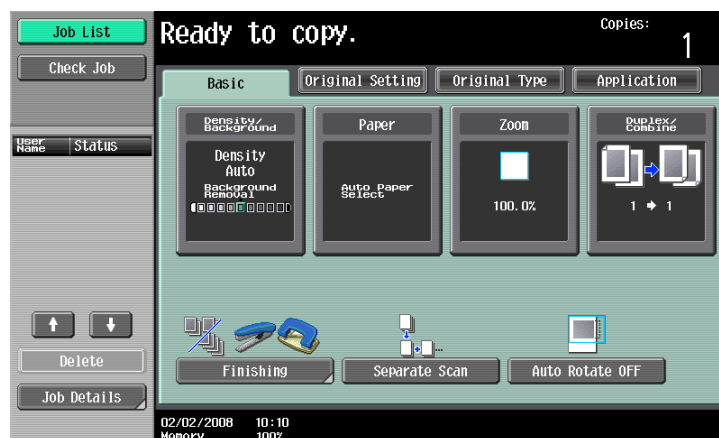

The Paper screen appears.

- 2 Touch the button for the bypass tray.

- If a setting for special paper is selected, the bypass is not selected automatically with the "Auto" Paper setting.
- The auto tray switch feature applies only to paper trays specified with the same paper type setting.



- 3 Touch [Change Tray Settings].
- 4 Select the appropriate setting for the type of special paper that is loaded.
 - Touch the button for the desired paper type.

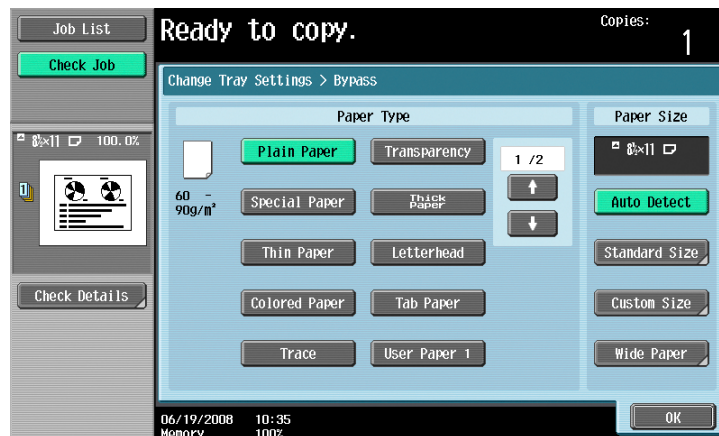

- 5 Touch [OK], and then touch [OK] in the next screen that appears. The Basic screen appears again.



Reminder

If special paper is loaded into the bypass tray, be sure to select the corresponding paper type, otherwise a paper misfeed may occur.

6.3 Paper type setting for a tray

This section describes the procedures for specifying the size of paper loaded in the tray 3 and 4 and the type of paper loaded in each paper tray.

6.3.1 To display the Paper Tray Setting screen

The following procedure describes how to display the Paper Tray Setting screen.

- 1 Press the [Utility/Counter] key.

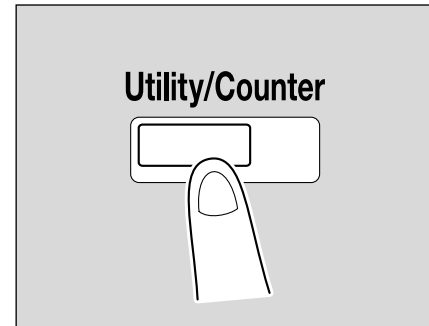

- 2 Touch [2 User Setting].

- An item can also be selected by pressing the key in the keypad for the number beside the desired button.
- For "2 User Setting", press the [2] key in the keypad.



- 3 Touch [1 System Setting].

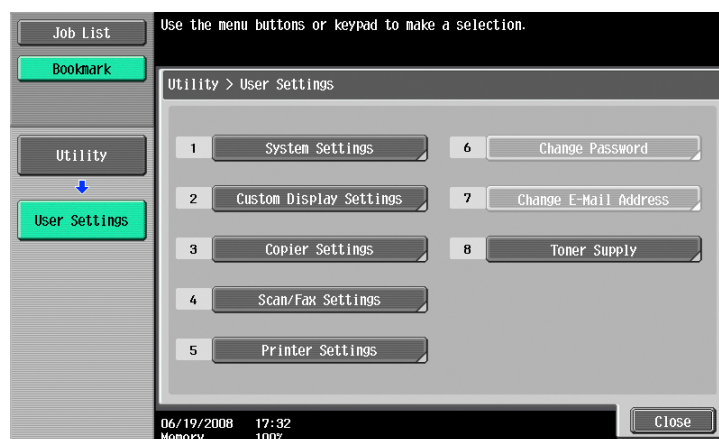

The System Setting screen appears.

4 Touch [3 Paper Tray Setting].

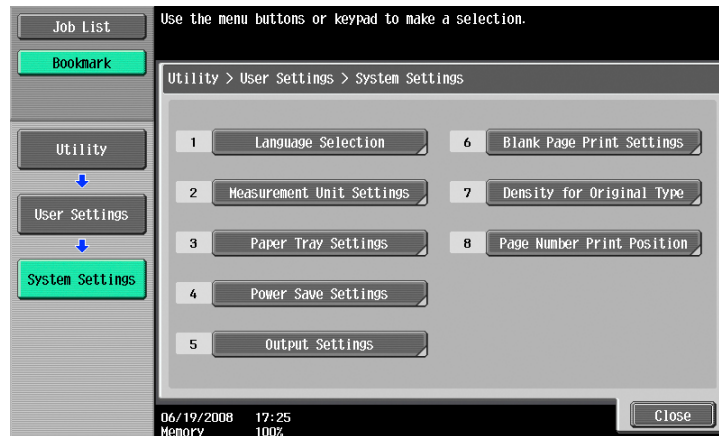

The Paper Tray Setting screen appears.

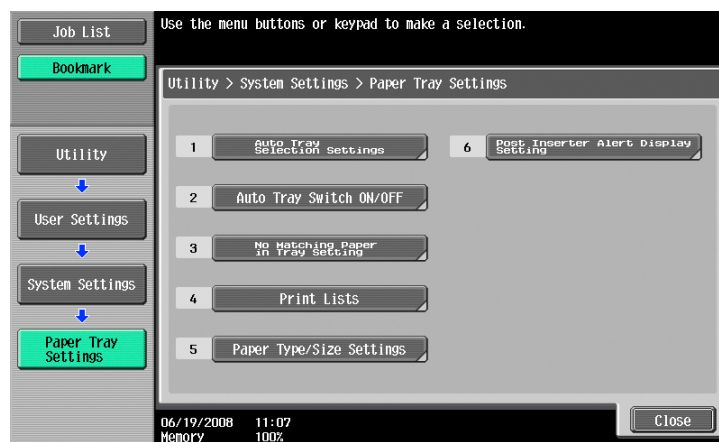

Note

To change the paper size for paper loaded into the tray 3 and 4 and the LCT, contact your service representative.

6.3.2 To specify a standard size paper (Standard Size 1 settings)

A standard paper size can be set for the tray 3 and 4.

The following procedure describes how to specify the setting for standard-sized paper loaded into the tray 3.

- 1 In the Paper Tray Setting screen, touch [5 Paper Type/Size Settings].
 - For details on displaying the Paper Tray Setting screen, refer to ["To display the Paper Tray Setting screen" on page 6-20](#).

- For details on loading the paper into tray 3 and 4, refer to ["Loading paper into the tray 3 or 4" on page 1-48.](#)

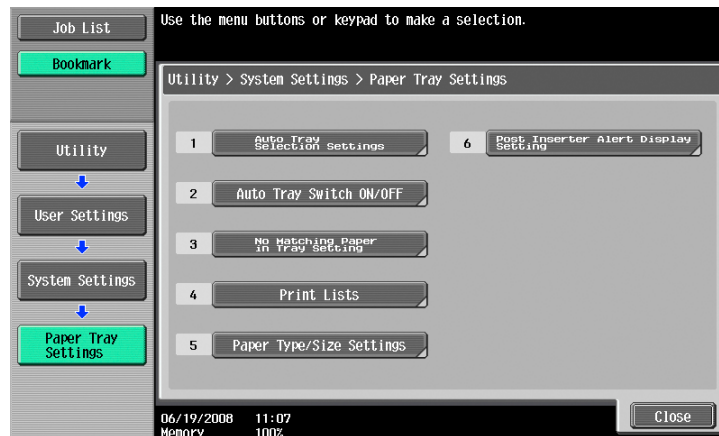

The Paper Type/Size settings screen appears.

- 2 Touch the button for the tray 3, and then touch [Standard Size 1] under "Paper Size".



- 3 Touch [OK].

If standard-sized paper is loaded into a paper tray, the paper size is automatically detected.

6.3.3 To specify a setting for standard special-sized paper (Special Size settings)

If standard centimeter-sized paper is being used in the tray 3 and 4, specify a setting for standard special-sized paper.

The following procedure describes how to specify the setting for standard special-sized paper loaded into the tray 3.

- 1 In the Paper Tray Setting screen, touch [5 Paper Type/Size Settings].
 - For details on displaying the Paper Tray Setting screen, refer to ["To display the Paper Tray Setting screen" on page 6-20.](#)

- For details on loading the paper into tray 3 and 4, refer to "Loading paper into the tray 3 or 4" on page 1-48.

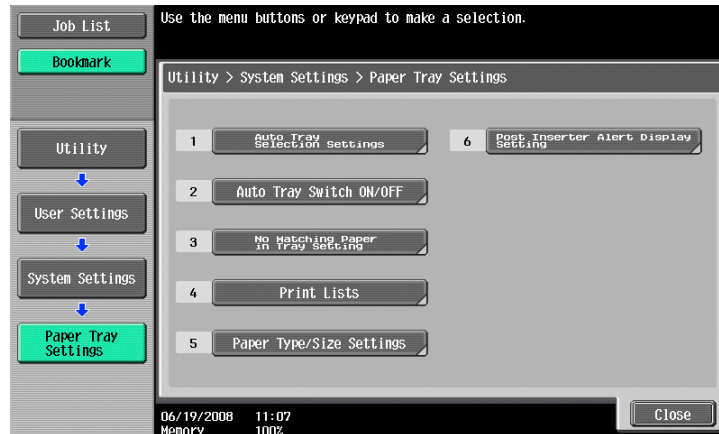

The Paper Type/Size Settings screen appears.

- 2 Touch the button for the tray 3, and then touch [Special Size] under "Paper Size".

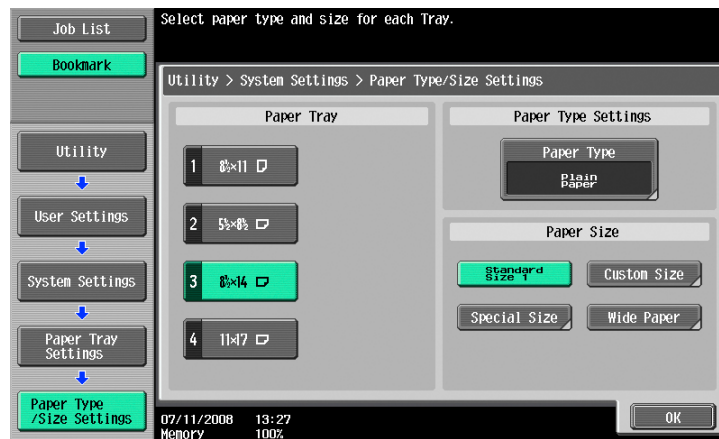

- 3 Select the size of the paper to be loaded.



- 4 Touch [OK].

6.3.4 To specify a non-standard paper size (Custom Size settings)

If custom-sized paper is being used in the tray 3 and 4, specify a setting for custom-sized paper.

The following procedure describes how to specify the setting for custom-sized paper loaded into the tray 3.

- 1 In the Paper Tray Setting screen, touch [5 Paper Type/Size Settings].
 - For details on displaying the Paper Tray Setting screen, refer to ["To display the Paper Tray Setting screen" on page 6-20](#).
 - For details on changing the paper size for the tray 3 and 4, refer to ["Loading paper of a different size into paper trays" on page 1-57](#).



The Paper Type/Size Settings screen appears.

- 2 Touch the button for the tray 3, and then touch [Custom Size] under "Paper Size".

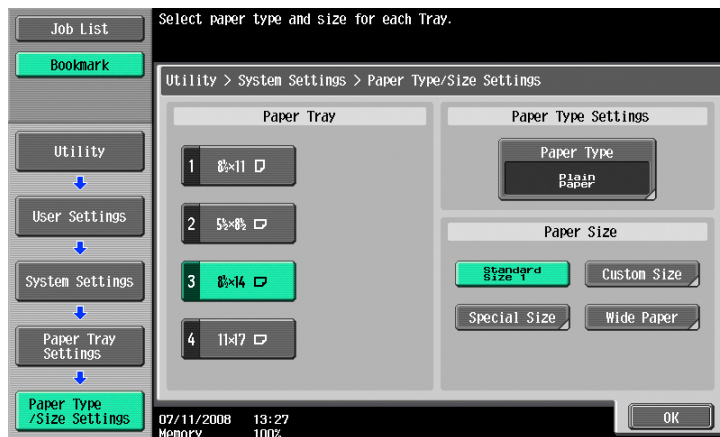

The Paper Size screen appears.

- 3 Type in the length (X) and width (Y) of the paper.
 - Touch [↔] to switch between the integer and the fraction, and then touch [-] and [+] to type in the length of side X. (5-1/2 in. to 18 in.)
 - Touch [↔] to switch between the integer and the fraction, and then touch [-] and [+] to type in the length of side Y. (7-3/16 in. to 12-3/8 in.)
 - If a decimal value is displayed in the screen, use the keypad to type in the length. For details on switching between decimal and fraction values, refer to ["System Settings" on page 11-23](#).

- If a decimal value is displayed in the screen and the specified value is outside the allowable range, the message "Input Error" appears. Type a value within the allowable range. If the value was incorrectly entered, press the [C] (clear) key to erase the value, and then specify the correct value.

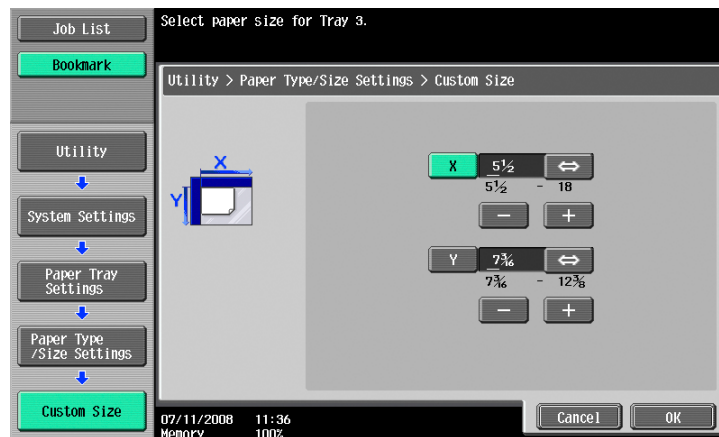

- 4 Touch [OK].

6.3.5 To select a setting for oversized paper

If paper one size larger than a standard size is being used in the tray 3 and 4, specify a setting for wide paper. The following procedure describes how to specify the setting for wide paper loaded into the tray 3.

- 1 In the Paper Tray Setting screen, touch [5 Paper Type/Size Settings].
 - For details on displaying the Paper Tray Setting screen, refer to ["To display the Paper Tray Setting screen" on page 6-20](#).
 - For details on loading the paper into tray 3 and 4, refer to ["Loading paper into the tray 3 or 4" on page 1-48](#).

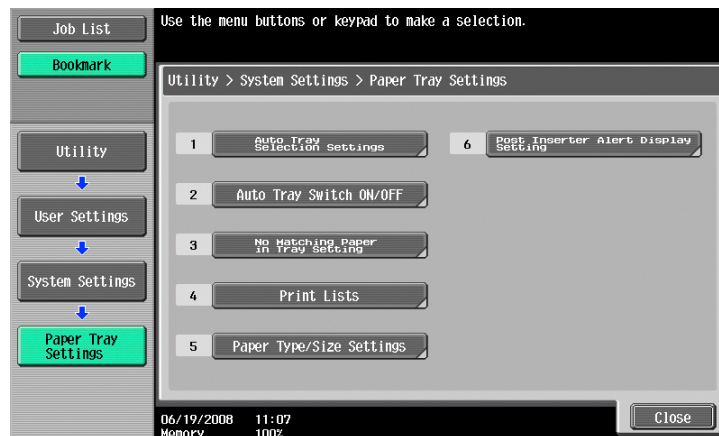

The Paper Type/Size Settings screen appears.

- 2 Touch the button for the tray 3, and then touch [Wide Paper] under "Paper Size".



The Paper Size screen appears.

- 3 Select the size of the paper to be loaded.
- Touch [X] or [Y] in "Change size", touch [↔] to switch between the integer and the fraction, and then touch [–] and [+] to specify the size of the paper.
 - If a decimal value is displayed in the screen, use the keypad to type in the setting. For details on switching between decimal and fraction values, refer to ["System Settings" on page 11-15](#).
 - If a decimal value is displayed in the screen and the specified value is outside the allowable range, the message "Input Error" appears. Type a value within the allowable range. If the value was incorrectly entered, press the [C] (clear) key to erase the value, and then specify the correct value.



- 4 Select the desired image position.

- 5 Touch [OK].

6.3.6 Specifying a paper type

This section describes the procedure for specifying a type of paper loaded in each tray.



Note

Selecting "Letterhead" will change the print side to the reverse side.

If a special paper type is selected, that tray is not selected automatically with the "Auto" Paper setting.

The auto tray switch feature applies only to the trays specified with the same paper type setting.

- 1 Press the [Utility/Counter].

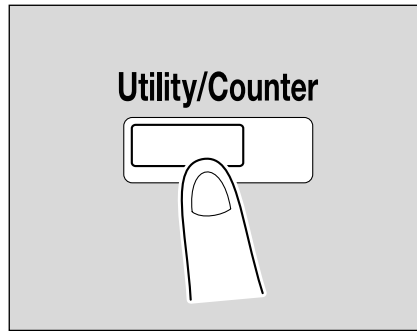

- 2 Touch [2 User Settings], [1 System Settings], [3 Paper Tray Settings], and [5 Paper Type/Size Settings] in sequence.

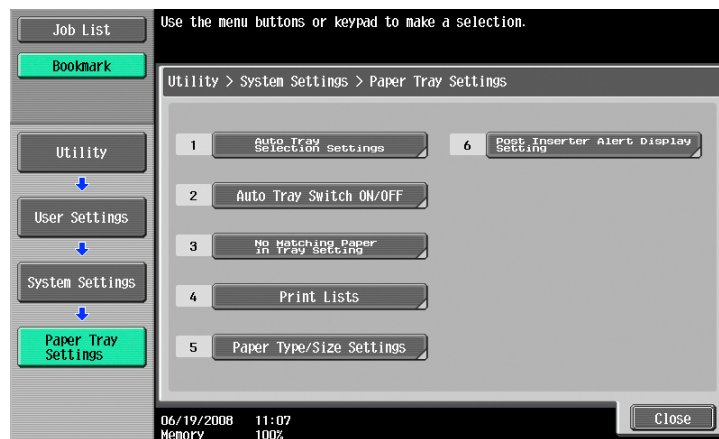

The Paper Type Settings screen appears.

- 3 Touch to highlight the desired tray key under "Paper Tray" in the left side area of the screen, then touch [Paper Type] on the right side.

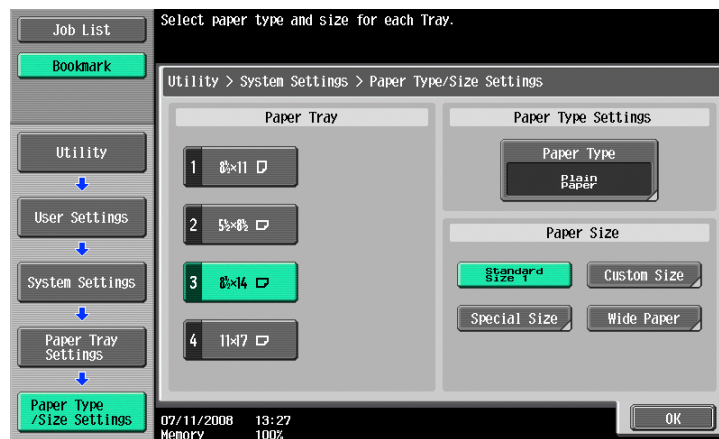

The Paper Type screen appears.

- 4 Touch the desired paper type key to highlight it.

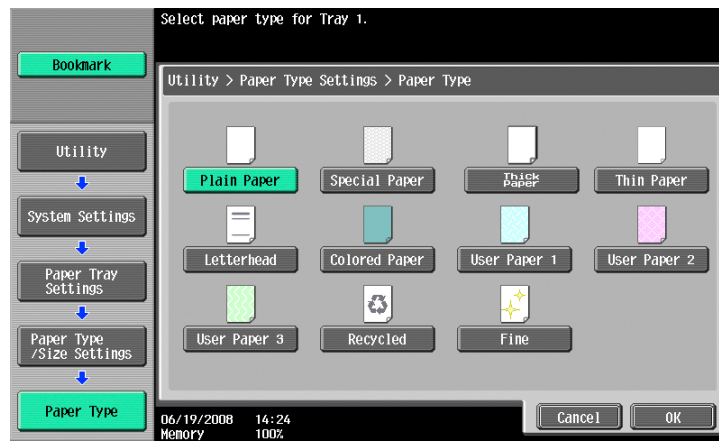

- 5 Touch [OK] to complete the setting.
 - To cancel the change, touch [Cancel].

6.4 Originals

When making copies, load the original into the ADF or position it on the original glass.

To copy originals that cannot be loaded into the ADF, position them on the original glass.











6.4.1 Originals that can be loaded into the ADF

There are two methods for using the ADF. The machine will detect the original size automatically when the original is positioned in the ADF, then select an appropriate paper size automatically by Auto Paper Select function.

There are limits on the types of original that can be positioned with each method.













- Normal method
- For originals of mixed sizes
- For Z-folded original

Normal method











Item	Description
Original paper weight	13-1/4 lb to 53-1/4 lb
Original size	3-15/16 × 5-1/2 to 11-11/16 × 17
Auto original size detect	11 × 17  , 8-1/2 × 14  , 8-1/2 × 11  , 7-1/4 × 10-1/2  , 5-1/2 × 8-1/2  , A3  , B4  , A4  , B5  , B6 
Curling tolerance	3/8 or less
Paper capacity	100 sheets (21-1/4 lb)

Mixed Original Setting







The following chart shows the possible combinations of standard- size paper that can be used with the "Mixed Original" setting.

Item	Description
Original paper weight	13-1/4 lb to 53-1/4 lb
Auto original size detect	Two types of size combination are determined by the ADF guide width. Width of 11 × 17  , 8-1/2 × 11  : 11 × 17  , 8-1/2 × 14  , 8-1/2 × 11  , 5-1/2 × 8-1/2  Width of 8-1/2 × 14  , 8-1/2 × 11  , 5-1/2 × 8-1/2  : 8-1/2 × 14  , 8-1/2 × 11  , 5-1/2 × 8-1/2 
Curling tolerance	3/8 or less
Paper capacity	100 sheets (21-1/4 lb)

Z-Folded Original Setting

Item	Description
Original paper weight	13-1/4 lb to 53-1/4 lb
Original size	3-15/16 × 5-1/2 to 11-11/16 × 17
Auto original size detect	11 × 17  , 8-1/2 × 14  , 8-1/2 × 11  , 7-1/4 × 10-1/2  , 5-1/2 × 8-1/2  , A3  , B4  , A4  , B5  , B6 
Curling tolerance	3/8 or less
Paper capacity	100 sheets (21-1/4 lb)

Tab Original Setting

Item	Description
Original paper weight	13-1/4 lb to 53-1/4 lb
Original size	8-1/2 × 14  , 8-1/2 × 11  , A3  , B4  , A4  , B5 
Curling tolerance	3/8 or less
Paper capacity	100 sheets (21-1/4 lb)

6.4.2 Precautions for loading originals into the ADF













The following types of original should not be positioned into the ADF, otherwise paper misfeeds, damage to the original or the machine trouble may occur.





- Wrinkled, folded, curled, or torn original
- Highly translucent or transparent original, such as overhead transparencies or trace paper
- Coated original such as carbon-backed paper
- Original printed on paper thicker than 53-1/2 lb
- Original printed on paper thinner than 13-1/4 lb
- Original printed on paper thicker than 13-1/4 lb during double-sided copying
- Original that are bound, for example, with staples or paper clips
- Original that are bound in a book or booklet
- Original that are bound together with glue
- Original pages that have been cut or contain cutouts
- Label sheets
- Offset printing masters
- Original with binder holes
- Original that have just been printed with this machine

6.4.3 Originals that can be loaded on the original glass

Use the original glass when originals are not suitable for use with the ADF, or when setting copying conditions incompatible with the ADF.

The machine will detect the original size automatically when the original is positioned on the original glass with ADF closed, then select an appropriate paper size automatically by Auto Paper Select function.

Item	Description
Original type	Sheets, books (spreads), three-dimensional objects
Original Size	5-1/16 × 5-1/2 to 11-11/16 × 17
Auto Original Size Detect	11 × 17  , 8-1/2 × 14  , 8-1/2 × 11  , 5-1/2 × 8-1/2  , A3  , B4  , A4  , B5  , A5  , B6  , Foolscap  , A5  , B6 
Maximum original weight	15 lb
Maximum original thickness	1-3/16

* Foolscap includes the following 4 types: 8-1/8 × 13-1/4 , 8-1/4 × 13 , 8-1/2 × 13 , 8 × 13 , one of which can be selected. For details, contact the service representative.

Observe the following precautions when placing the original on the original glass.

- The size of original printed on paper in AB sizes (such as A3, B4, A4) cannot be automatically detected. The setting must be specified by the service representative. For details, contact the service representative.
- If a custom-sized original is positioned, the "Auto Paper Select" and "Auto Zoom" settings cannot be used since the original size cannot be detected automatically. If a custom-sized original is positioned, select the size of the paper to be copied.
- If highly translucent or transparent original, such as overhead transparencies or trace paper, are positioned, the original size cannot be detected automatically. Place a blank sheet of paper of the same size over the original.
- Do not place objects exceeding 15 lb on the original glass, otherwise the original glass may be damaged.
- If a book is placed on the original glass, do not press it down extremely hard, otherwise the original glass may be damaged.



Application functions

7 Application functions

7.1 Inserting paper between OHP transparencies ("OHP Interleave" function)

In order to prevent copies printed onto OHP transparencies from sticking together as a result of the heat that is produced during copying, paper (interleaves) can be inserted between the transparencies. The interleaf can be kept blank, or copied from the same original as the transparency.

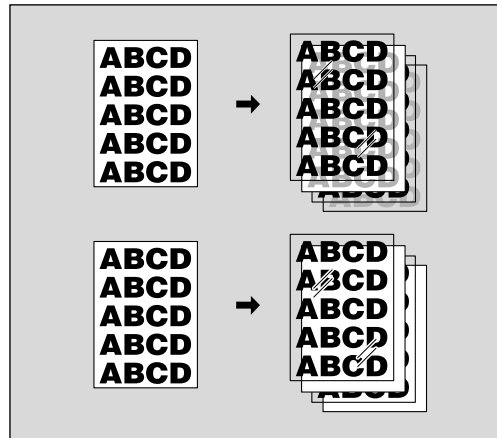

✓ No Finishing setting can be used.

- 1 Position the original to be copied.
 - For details on positioning the original, refer to ["Feeding the original" on page 2-6](#).
 - For details on loading OHP transparencies, refer to ["Paper Weight" on page 6-2](#) and ["Loading paper into the bypass tray" on page 1-53](#).
- 2 Load the OHP transparencies into the bypass tray, and load the interleaf paper into the desired paper tray.
 - Use interleaf paper with the same size as the OHP transparencies.
- 3 Select [Transparency] as the paper type for the bypass tray, and then touch [OK].
 - For details on specifying the paper type settings, refer to ["Specifying a paper type for bypass tray" on page 6-18](#).

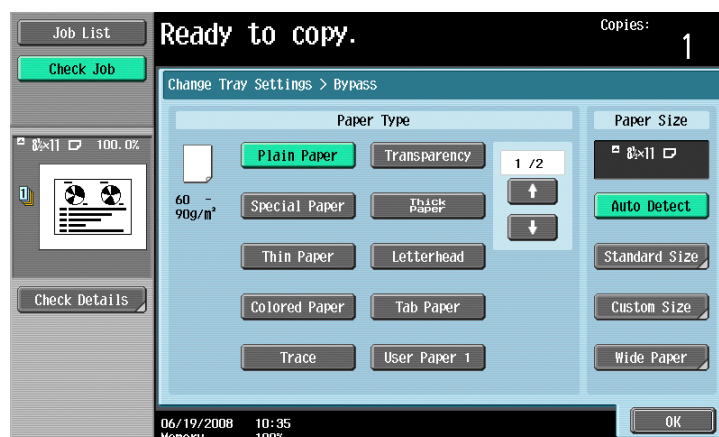

- 4 Touch [Application], and then touch [Sheet/Cover/Chapter Insert].

- To cancel changes to the settings for all Application functions, press the [Reset] key. All changes to the settings are canceled.



The Sheet/Cover/Chapter Insert screen appears.

- 5 Touch [OHP Interleave].

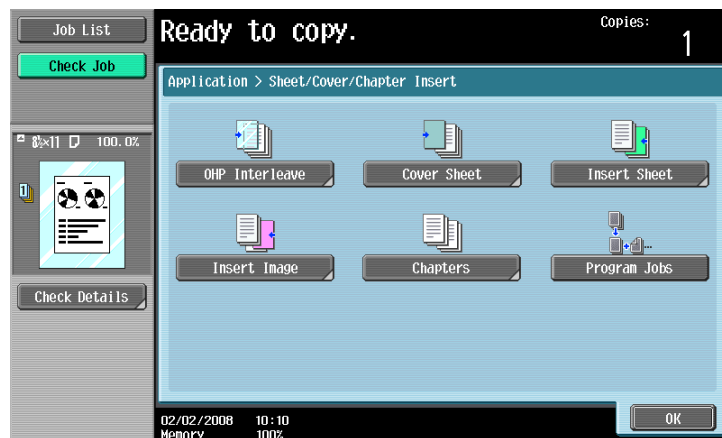

The OHP Interleave screen appears.

- 6 Select the paper tray loaded with the interleaf paper.
 - To cancel the setting and select the default, press the [Reset] key.
 - To cancel the "OHP Interleave" function, touch [No].

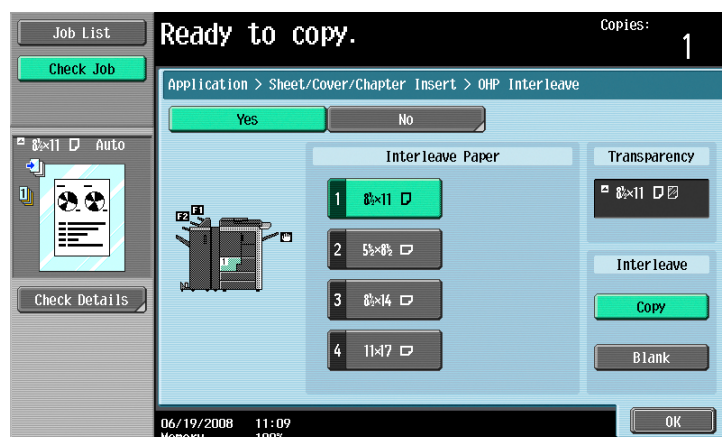

- 7 Select [Copy] or [Blank].
 - Selecting [Copy] will copy the original image also onto interleaves. To leave the interleaves blank, touch [Blank].
- 8 Touch [OK].

- 9 Specify any other desired copy settings.
 - The number of copies is set to "1" and cannot be changed.
- 10 Press the [Start] key.

7.2 Adding cover pages ("Cover Sheet" function)

Copies can be made using paper different from the main body of the original (excluding the cover pages), and cover pages can be added using paper different from the copy.

The following types of cover pages and front and back cover page settings are available.

Setting		Description
Front Cover	Front (Copy)	The first page of the original is copied onto paper for the front cover sheet. With double-sided copying, the second page of the original is copied onto the back of the front cover sheet.
	Front (Blank)	Paper for the front cover sheet is added as the first page of the copy. The same operation is performed with double-sided copying.
Back Cover	Back (Copy)	The last page of the original is copied onto the back cover page. With double-sided copying, a double-sided copy of the last two pages of the original is printed on paper for the back cover sheet if the original contains an even number of pages.
	Back (Blank)	Paper for the back cover sheet is added after the last page of the copy. The same operation is performed with double-sided copying.

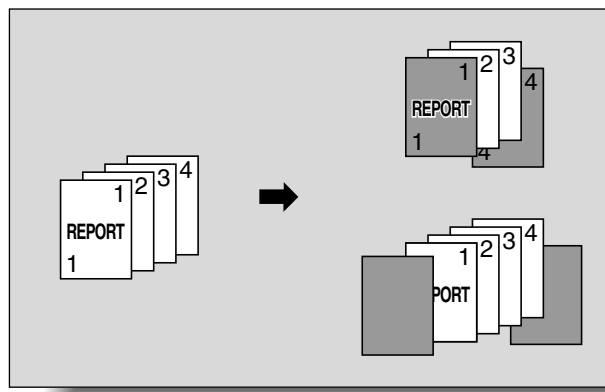

Note

If the optional post inserter is installed, outer front and back cover pages can be inserted from the post inserter.

Cover page settings can be specified for paper loaded in the post inserter and in the paper trays. Paper loaded in the post inserter is added at the front when it is specified as the outer front cover or it is added at the back when it is specified as the outer back cover.

- 1 Position the original to be copied.
 - For details on positioning the original, refer to ["Feeding the original" on page 2-6](#).
 - For an original that exceeds 100 pages, refer to ["Scanning the original in separate batches \("Separate Scan" setting\)" on page 2-8](#).
- 2 Load the paper for the cover pages and the paper for the main body of the original into separate paper trays.
 - Use paper with the same size for the cover pages and for the main body of the original, and load them in the same orientation.
- 3 Touch [Application], and then touch [Sheet/Cover/Chapter Insert].
 - For details on using thick paper for the cover sheets and on loading the paper, refer to ["Paper Weight" on page 6-2](#) and ["Loading paper into the bypass tray" on page 1-53](#).

- To cancel changes to the settings for all Application functions, press the [Reset] key. All changes to the settings are canceled.

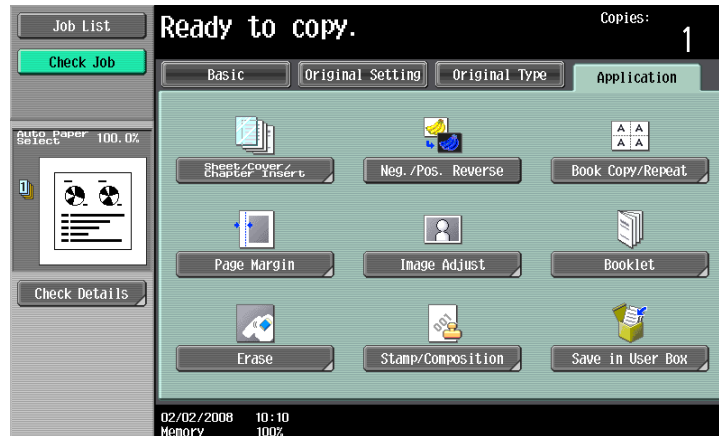

The Sheet/Cover/Chapter Insert screen appears.

- 4 Touch [Cover Sheet].

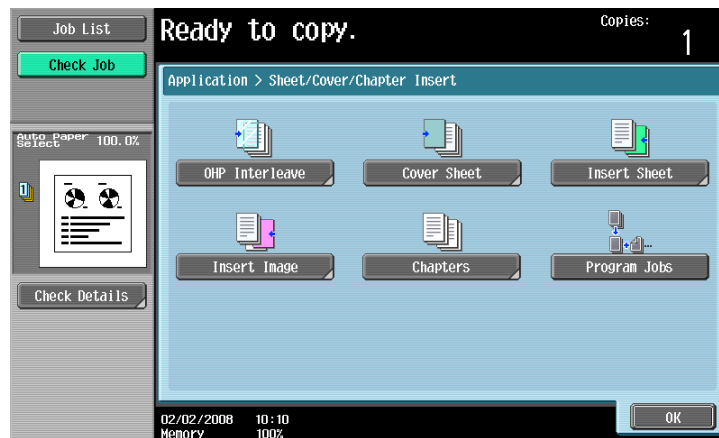

The Cover Sheet screen appears.

- 5 Select the desired cover page settings.
 - To cancel the setting and select the default, press the [Reset] key.
 - To cancel the "Cover Sheet" function, touch [No].
 - The default setting for the paper tray loaded with cover pages can be specified from the Utility mode. For details, refer to ["Copier Settings" on page 11-18](#).
 - If the optional post inserter has been installed, [Outer Cover Sheet] appears.

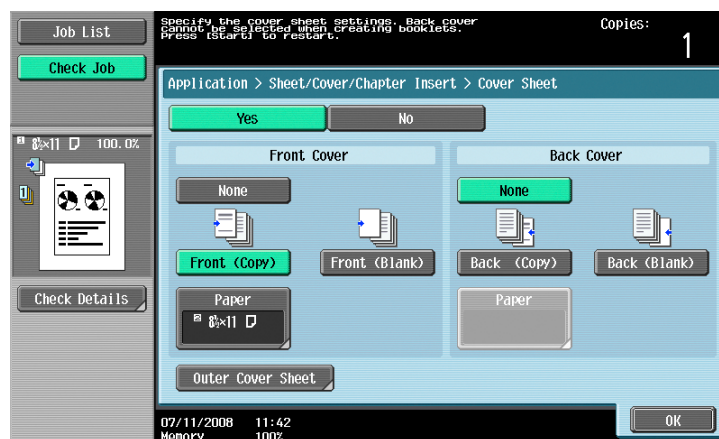

- If paper for cover pages has been loaded in the main unit, continue with step 6.
- If paper for cover pages has been loaded in a tray of the post inserter, continue with step 9.

- 6 If desired, touch [Paper] under "Front Cover" or "Back Cover".

The corresponding Cover Paper screen appears.

- 7 Select the paper tray loaded with the paper for the cover pages.

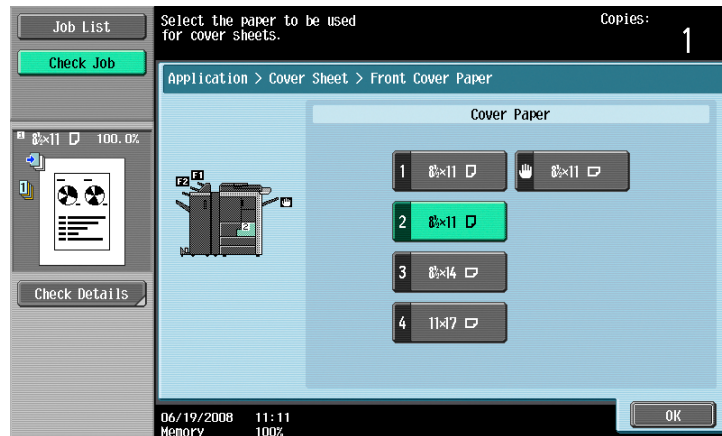

- 8 Touch [OK], and then touch [OK] in the next two screen that appears.

- 9 Touch [Outer Cover Sheet], and then specify the tray loaded with paper for the outer front cover or the outer back cover.

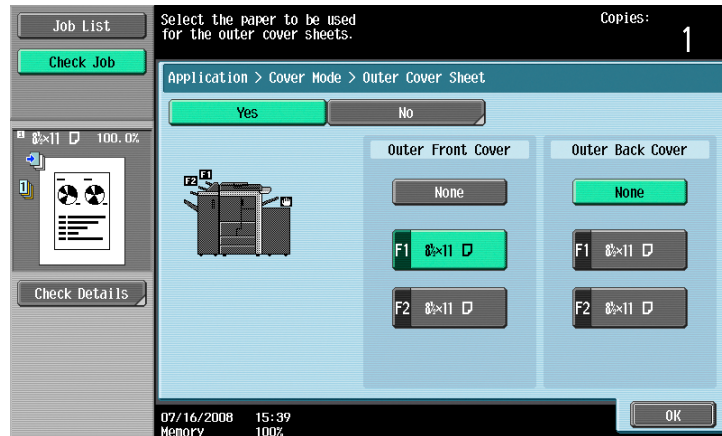

- 10 Specify any other desired copy settings.
- 11 Using the keypad, type in the desired number of copies.
- 12 Press the [Start] key.

7.3 Inserting different paper into copies ("Insert Sheet" function)

Different paper (such as colored paper) can be inserted for specified pages in the copies.

There are settings ("Copy" and "Blank") for selecting whether or not the inserted pages are printed. When the settings are combined with single-sided copying or double-sided copying, the copies are printed as shown below.

If "Copy" is selected, the original is copied with the specified paper inserted for the specified pages.

When page 2 is specified

Finishing	Description
Single-sided copies	The specified paper is inserted for the 2nd sheet of the copy, and the 2nd sheet of the original is copied onto it.
Double-sided copies	The back side of the 1st sheet of the copy is left blank, the specified paper is inserted for the 2nd sheet of the copy, and a double-sided copy of the 2nd and 3rd sheets of the original are printed onto it.

Copy

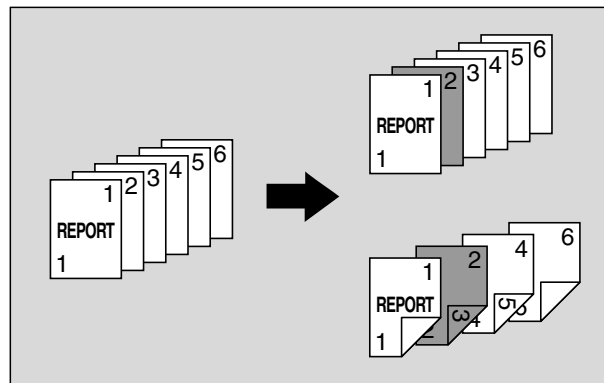

If "Blank" is selected, the specified paper is inserted after the specified page.

When page 3 is specified

Finishing	Description
Single-sided copies	The specified paper is inserted as the 4th sheet of the copy.
Double-sided copies	The back side of the 2nd sheet of the copy is left blank, and the specified paper is inserted for the 3rd sheet of the copy.

Blank

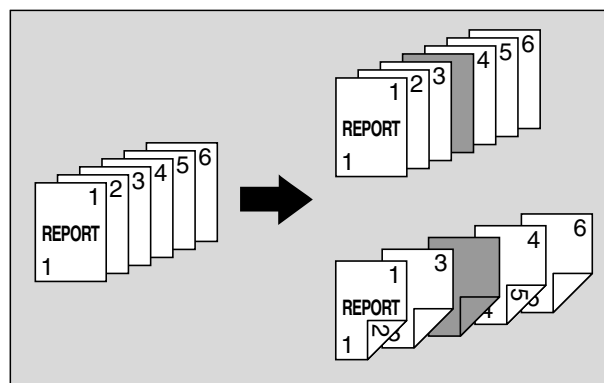



Detail

The specified paper can be inserted at a maximum of 30 locations within an original of up to 999 pages.

In double-sided originals, one double-sided page is considered to be two pages (one for the front and one for the back).



Note

If the optional post inserter is installed, paper can be inserted from the post inserter.

- 1 Position the original to be copied.
 - For details on positioning the original, refer to ["Feeding the original" on page 2-6](#).
 - For an original that exceeds 100 pages, refer to ["Scanning the original in separate batches \("Separate Scan" setting\)" on page 2-8](#).
- 2 Load the paper to be used for the insertions sheets and the main body of the original into the desired paper trays.
 - Use paper with the same size for the insertion sheets and for the main body of the original, and load them in the same orientation.
 - To cancel changes to the settings for all Application functions, press the [Reset] key. All changes to the settings are canceled.
- 3 Touch [Application], and then touch [Sheet/Cover/Chapter Insert].
 - For details on using thick paper for the insertion sheets and on loading the paper, refer to ["Paper Weight" on page 6-2](#) and ["Loading paper into the bypass tray" on page 1-53](#).
 - To cancel the setting and select the default, press the [Reset] key.

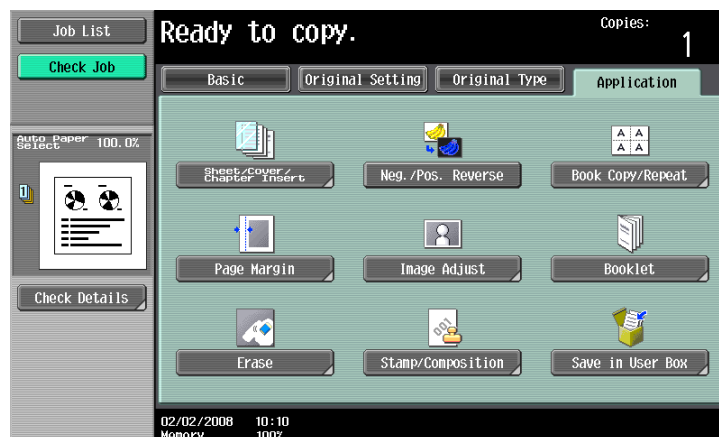

The Sheet/Cover/Chapter Insert screen appears.

- 4 Touch [Insert Sheet].
 - To cancel the "Insert Sheet" function, touch [No].

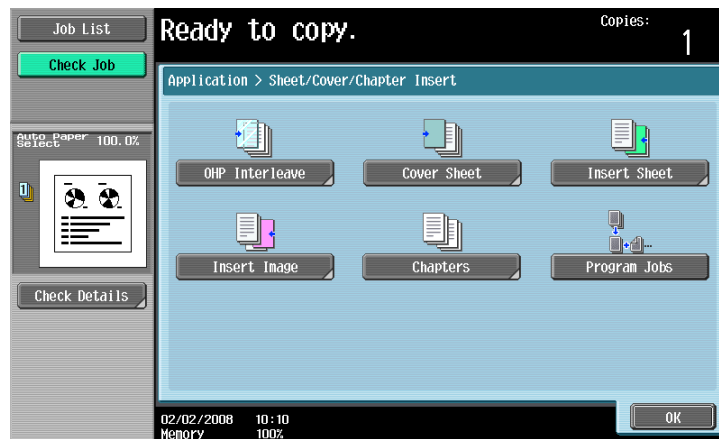

The Insert Sheet screen appears.

- 5 Touch a button for a page number, and then use the keypad to type in the number of the page where the paper is to be inserted.
 - There are two Insert Sheet screens. Touch [↑] or [↓] to display a different screen.
 - To arrange the page numbers in order, starting with the lowest number, touch [Sort].
 - To remove a page number that has been specified, touch the button for the page to be removed, and then press the [C] (clear) key.
 - If the same page number is entered multiple times, copying is not possible. Delete repeated page numbers.
 - If the entered page number is greater than the number of pages in the original, paper is not inserted.
 - [Post Inserter] appears if the optional post inserter has been installed.

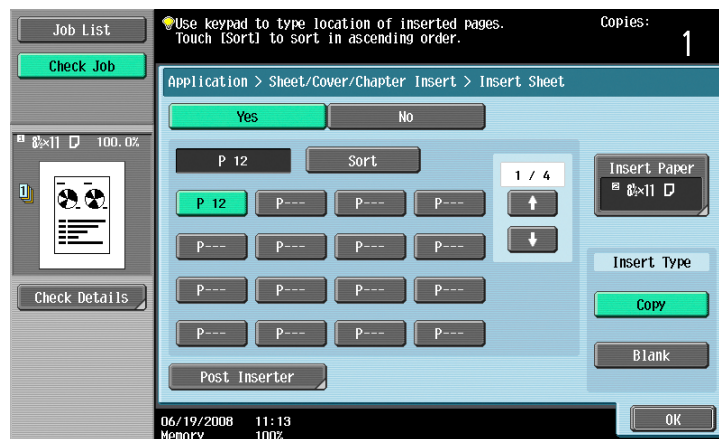

- If the insertion sheets are loaded into a paper tray of the main unit, continue with step 6.
- If the insertion sheets are loaded into a tray of the post inserter, continue with step 10.

- 6 Under "Insert Type", touch either [Copy] or [Blank].
 - If "Copy" is selected, the original is copied with the specified paper inserted for the specified page.
 - If "Blank" is selected, the specified paper is inserted after the specified page.

- 7 Touch [Insert Paper].

The Insert Paper Settings screen appears.

- 8 Select the paper tray loaded with the paper for the insertion sheets, and then touch [OK].
 - If [Blank] is selected in step 6, the Post Inserter can be selected for paper tray.

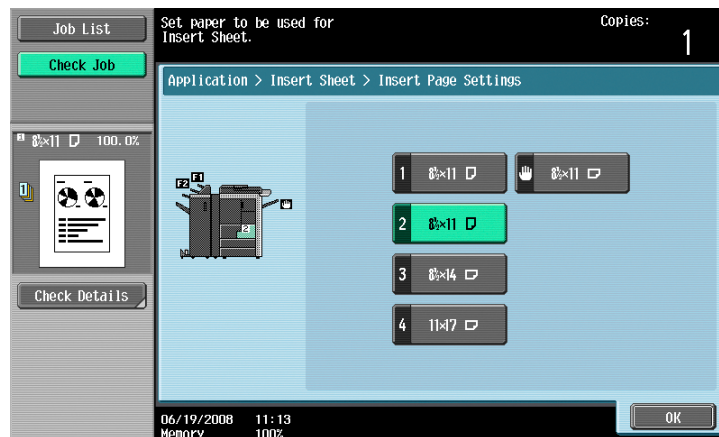

- 9 Touch [OK], and then touch [OK] in the next screen that appears.

- 10 Touch [Post Inserter].

- Touch a button for a page number, and then use the keypad to type in the number of the page where the paper is to be inserted.

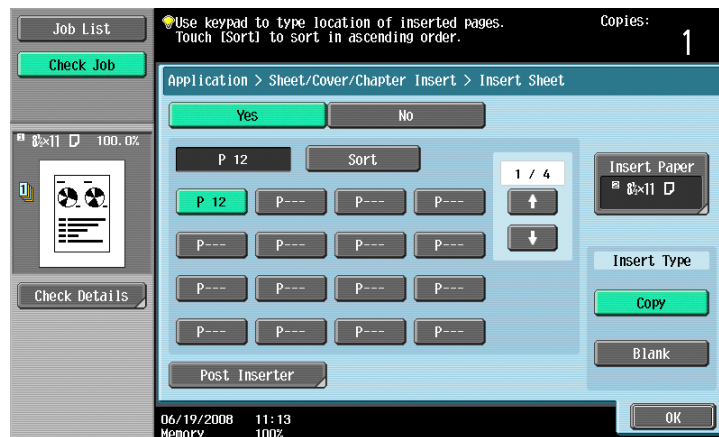

- There are two Post Inserter screens. Touch [↑] or [↓] to display a different screen.
- To arrange the page numbers in order, starting with the lowest number, touch [Sort].
- To remove a page number that has been specified, touch the button for the page to be removed, and then press the [C] (clear) key.
- If the same page number is entered multiple times, copying is not possible. Delete repeated page numbers.
- If the entered page number is greater than the number of pages in the original, paper is not inserted.

- 11 Select the paper tray loaded with the paper for the insertion sheets, and then touch [OK].

- 12 Touch [OK], and then touch [OK] in the next screen that appears.

- 13 Specify any other desired copy settings.

- 14 Using the keypad, type in the desired number of copies.

- 15 Press the [Start] key.

7.4 Inserting copies of a different original for a specified page ("Insert Image" function)

A multi-page original later scanned from the original glass can be inserted at the specified location in an original first scanned with the ADF. The inserted original is added after the specified pages.



Detail

A separate original can be inserted at a maximum of 30 locations within an original of up to 999 pages.

In double-sided originals, one double-sided page is considered to be two pages (one for the front and one for the back).

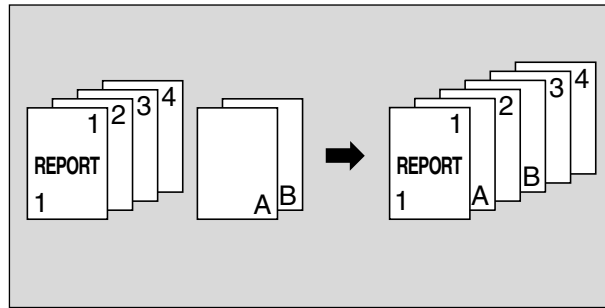

- 1 Load the original into the ADF.
 - For details on positioning the original, refer to ["Feeding the original" on page 2-6](#).
 - For an original that exceeds 100 pages, refer to ["Scanning the original in separate batches \("Separate Scan" setting\)" on page 2-8](#).
- 2 Touch [Application], and then touch [Sheet/Cover/Chapter Insert].
 - To cancel changes to the settings for all Application functions, press the [Reset] key. All changes to the settings are canceled.

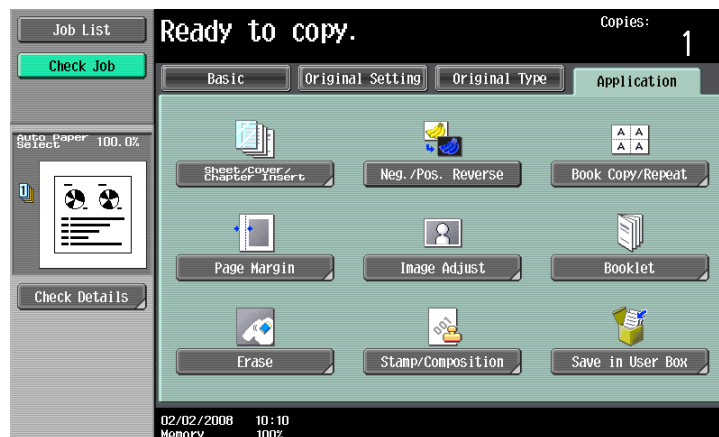

The Sheet/Cover/Chapter Insert screen appears.

- 3 Touch [Insert Image].
 - To cancel the setting and select the default, press the [Reset] key.
 - To cancel the "Insert Image" function, touch [No].

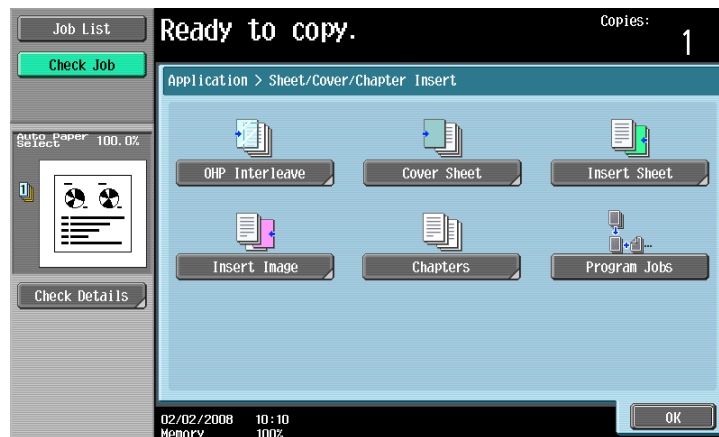

The Insert Image screen appears.

- 4 Using the keypad, specify the pages where the image is to be inserted.

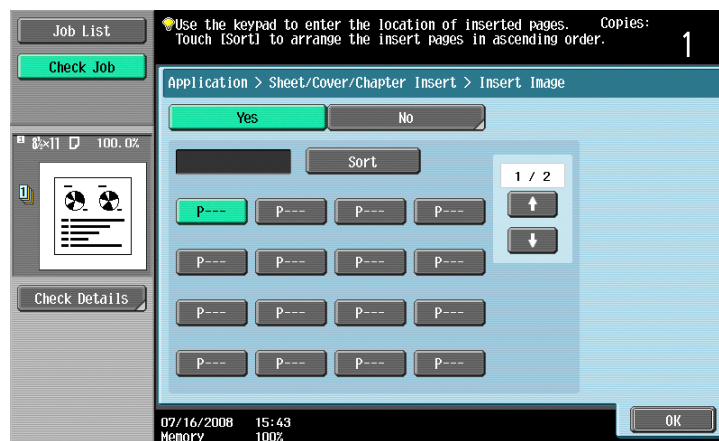

- There are two Insert Image screens. Touch [↑] and [↓] to display a different screen.
- The inserted original is added after the specified page.
- To arrange the page numbers in order, starting with the lowest number, touch [Sort].
- To remove a page number that has been specified, touch the button for the page to be removed, and then press the [C] (clear) key.
- If the original scanned from the original glass has more pages than the number of pages specified in the Insert Image screen, the extra pages of the insertion original are printed at the end of the original.
- If the original scanned from the original glass has fewer pages than the number of pages specified in the Insert Image screen, the missing insertion pages are not printed.
- If the same page number is specified twice, two insertion original pages are added at the specified location.
- If the specified page number is greater than the total number of pages in the main original, the corresponding insertion original page is added at the end of the original copy.

- 5 Touch [OK], and then touch [OK] in the next screen that appears.
- 6 Specify any other desired copy settings.
- 7 Using the keypad, type in the desired number of copies.

- 8 Press the [Start] key.
Scanning begins.

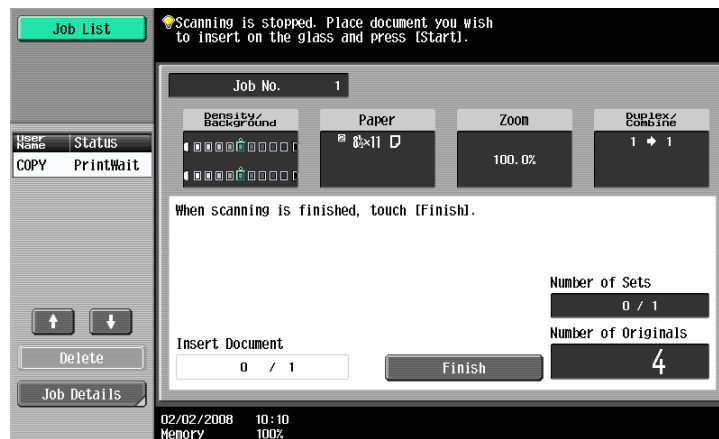

- 9 Place the original to be inserted on the original glass.
– For details on positioning the original, refer to ["Feeding the original" on page 2-6](#).
- 10 Press the [Start] key.
Scanning begins.
- 11 Touch [Finish].

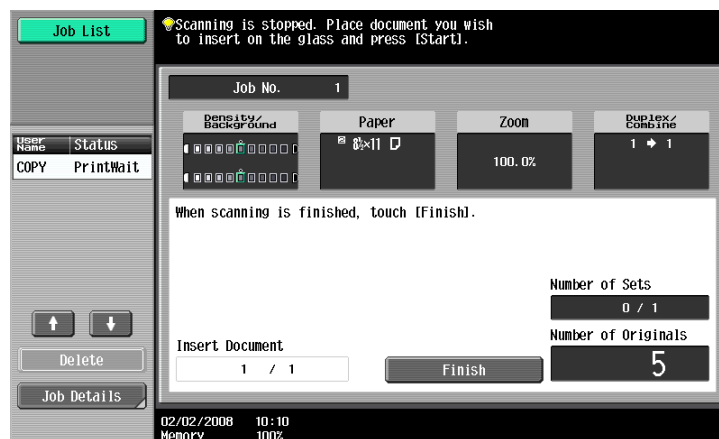

- To insert a multi-page original, repeat steps 9 and 10 until all pages of the insertion original are scanned in the order that they are to be inserted.

- 12 Press the [Start] key.

7.5 Specifying pages to be printed on the front side ("Chapters" function)

When making double-sided copies, the pages specified as the first page of a chapter can be printed on the front side of the paper. If the original was arranged so that the specified page would be printed on the back side of a page, the page is left blank and the specified page is printed on the front side of the next page. In addition, the specified page can be printed on different paper.



Detail

A maximum of 30 pages can be specified to be printed on the front side of the paper within an original of up to 999 pages.

In double-sided originals, one double-sided page is considered to be two pages (one for the front and one for the back).

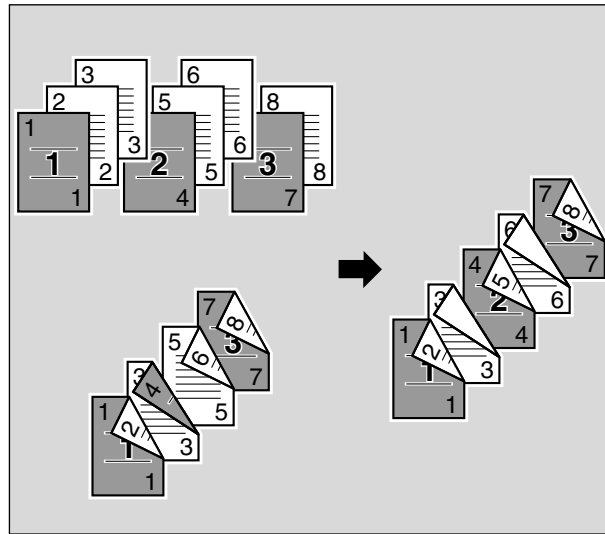

Note

Make sure that the paper loaded for the first page of the chapter and for the copy have the same size and orientation.

- 1 Position the original to be copied.
 - For details on positioning the original, refer to ["Feeding the original" on page 2-6](#).
 - For an original that exceeds 100 pages, refer to ["Scanning the original in separate batches \("Separate Scan" setting\)" on page 2-8](#).

- 2 Touch [Application], and then touch [Sheet/Cover/Chapter Insert].
 - To cancel changes to the settings for all Application functions, press the [Reset] key. All changes to the settings are canceled.

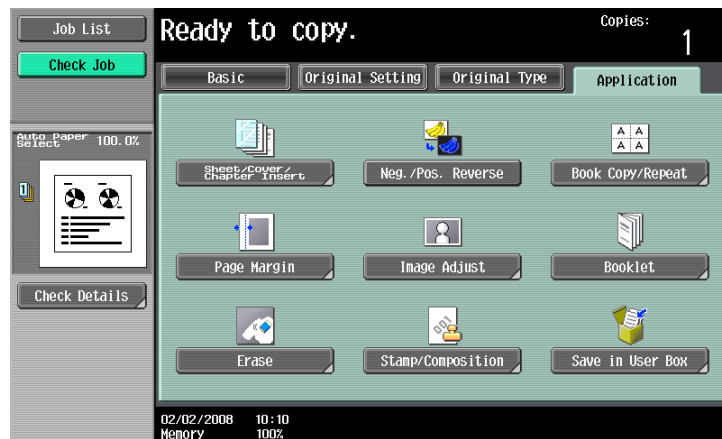

The Sheet/Cover/Chapter Insert screen appears.

- 3 Touch [Chapters].

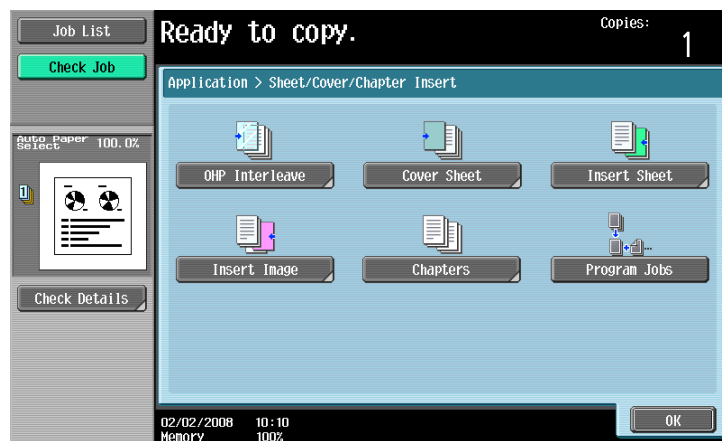

The Chapter screen (for editing) appears.

- 4 Using the keypad, specify the first page of the chapters.

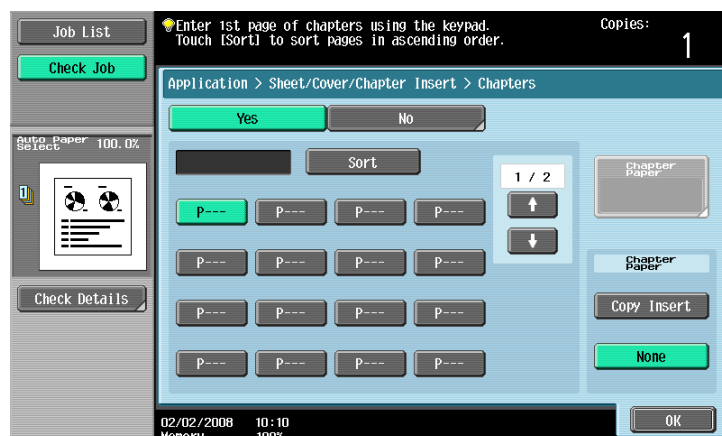

- There are two Chapter screens. Touch [↑] and [↓] to display a different screen.
- To arrange the page numbers in order, starting with the lowest number, touch [Sort].
- To remove a page number that has been specified, touch the button for the page to be removed, and then press the [C] (clear) key.
- Under "Original > Copy", select "1-Sided > 2-Sided".
- If the same page number is entered multiple times, copying is not possible. Delete repeated page numbers.

- If the specified page number is greater than the number of pages in the original, that page number is ignored.

5 Under "Chapter Paper", touch [Copy Insert] or [None].

- If "None" is selected, all pages of the copy are printed on the same paper.
- To cancel the setting and select the default, press the [Reset] key.
- To cancel the "Chapters" function, touch [No].

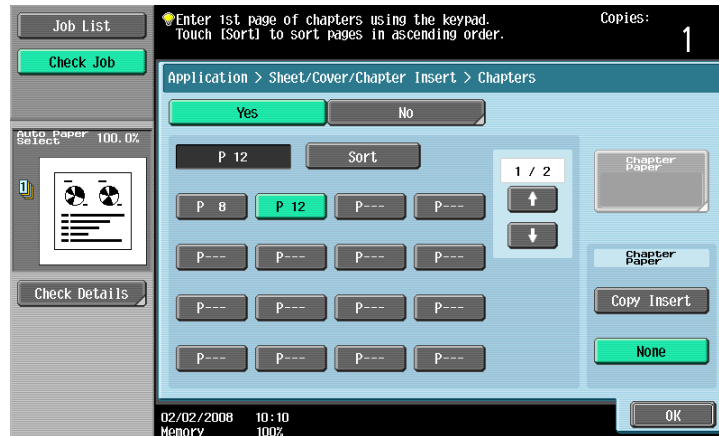

- If "Copy Insert" is selected, [Chapter Paper] appears. Touch [Chapter Paper], select the paper to be used for the first page of the chapter, and then touch [OK].

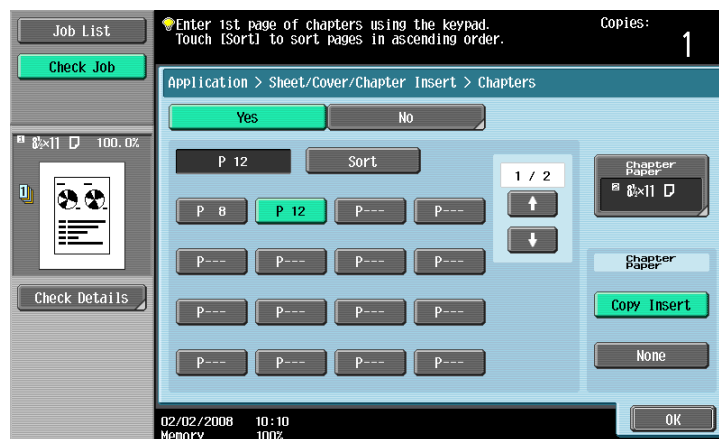

6 Touch [OK], and then touch [OK] in the next screen that appears.

7 Specify any other desired copy settings.

8 Using the keypad, type in the desired number of copies.

9 Press the [Start] key.

7.6 Scanning originals with different settings and printing copies all together ("Program Jobs" function)

Loaded original pages can be scanned with different settings and their copies can be printed together. Different Zoom or Paper settings can be specified for a part of the original or Finishing settings or a numbering function can be set after the entire original is scanned, and then all copies can be printed together.

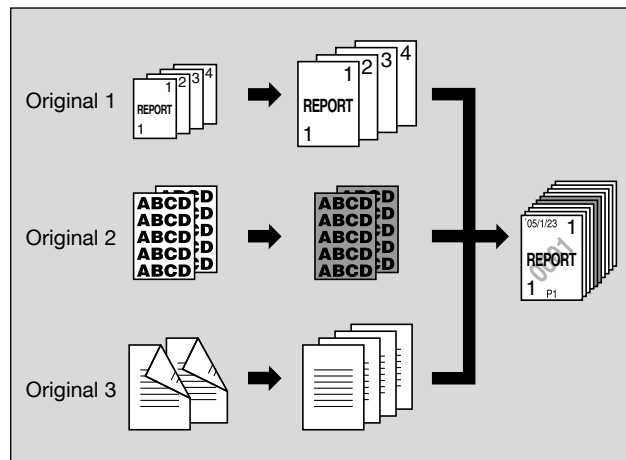

Note

100 original batches can be set.

The "Group" Finishing setting is not available when programming jobs. Instead, select "Sort".

- 1 Position the original to be copied.
 - For details on positioning the original, refer to "[Feeding the original](#)" on page 2-6.
 - When saving scanned data in a user box, some scanned data may be lost if more than 10,000 pages are saved in the box.
- 2 Touch [Application], and then touch [Sheet/Cover/Chapter Insert].
 - To cancel changes to the settings for all Application functions, press the [Reset] key. All changes to the settings are canceled.

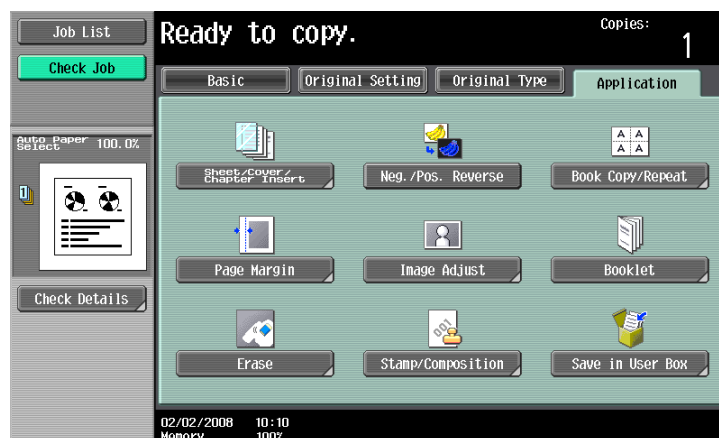

The Sheet/Cover/Chapter Insert screen appears.

- 3 Touch [Program Jobs], and then touch [OK].

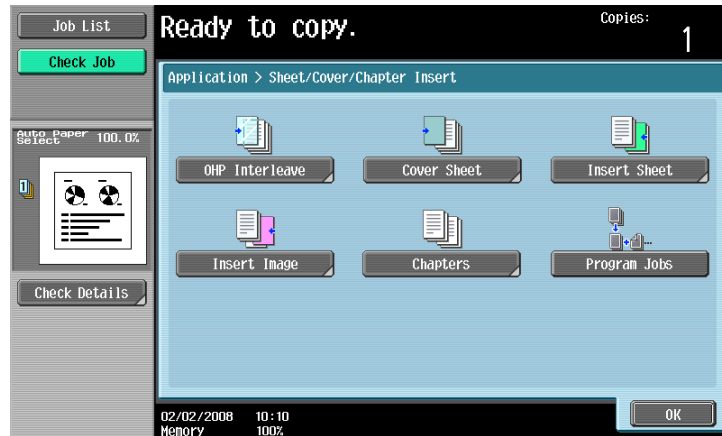

- 4 Select the desired copy settings, and then press the [Start] key.
 – To print a single copy to be checked, press the [Proof Copy] key.
 Scanning begins.

- 5 Touch [Fix], and then touch [OK].



- If the original was loaded on the original glass, touch [Finish] in the screen that appears, requesting confirmation that scanning is finished.
- If "Retry" was selected, touch [Change Setting] to change the copy settings.

- 6 Position the next original, and then touch [Change Setting].

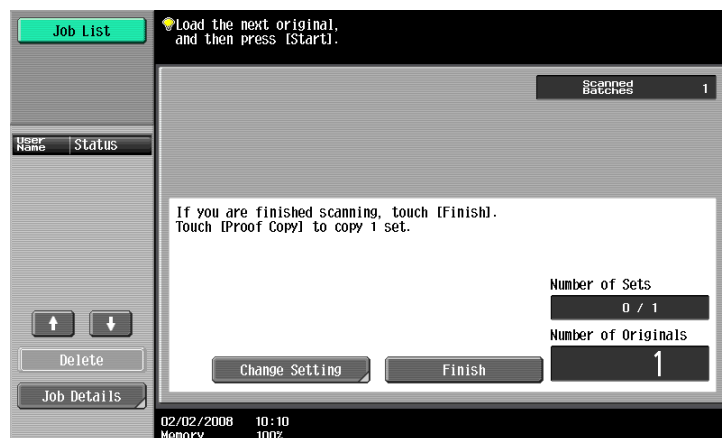

- 7 Select the desired copy settings, and then press the [Start] key.

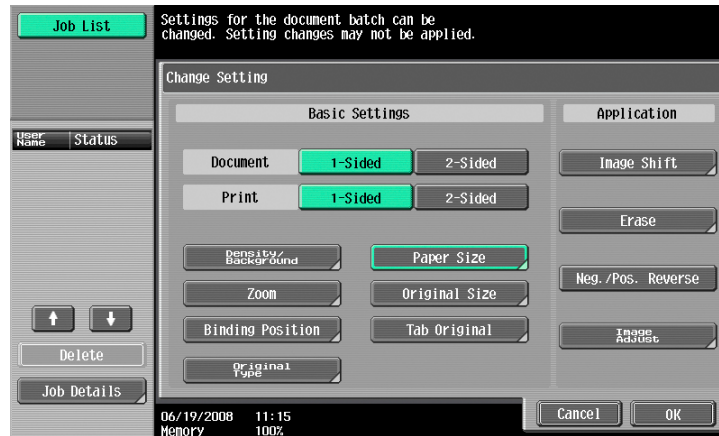

- To print a single copy to be checked, press the [Proof Copy] key.
- Repeat steps 5 to 7 until all originals have been scanned. The amount of memory available can be checked beside "Memory" in the lower-left corner of the screen. In addition, the number of original batches can be checked beside "Scanned Batches".
- When the memory is full, a message appears. Select whether to delete the last part of the data and scan it again, delete the last part of the data and print, or delete all of the original data.
- To cancel changes to the settings, touch [Cancel].

Scanning begins. After scanning is finished, touch [Fix], and then touch [OK].

? Is there more information about the settings?

→ Refer to the appropriate section.

- 8 After all original pages have been scanned, touch [Finish].

A message appears, requesting confirmation that scanning is finished.

- 9 Touch [Yes], and then touch [OK].

- If "No" was selected, touch [Change Setting] to change the copy settings.

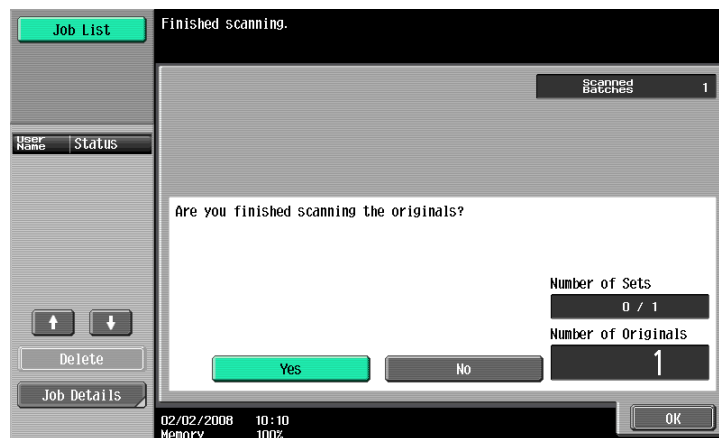

10 Specify any other desired copy settings.

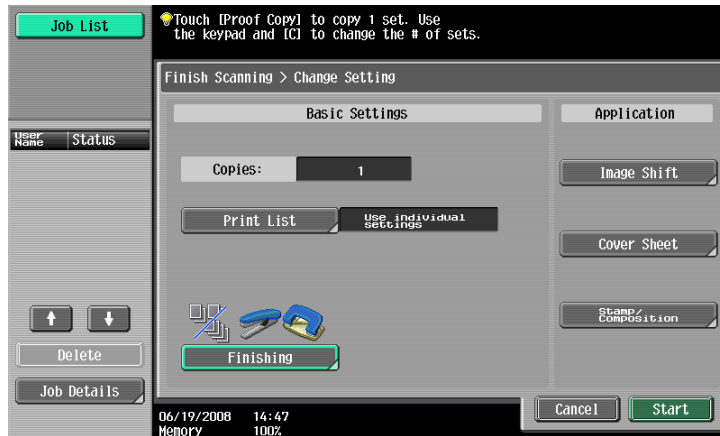

- Touch [Print List], and then specify the printing method for the entire scanned original.

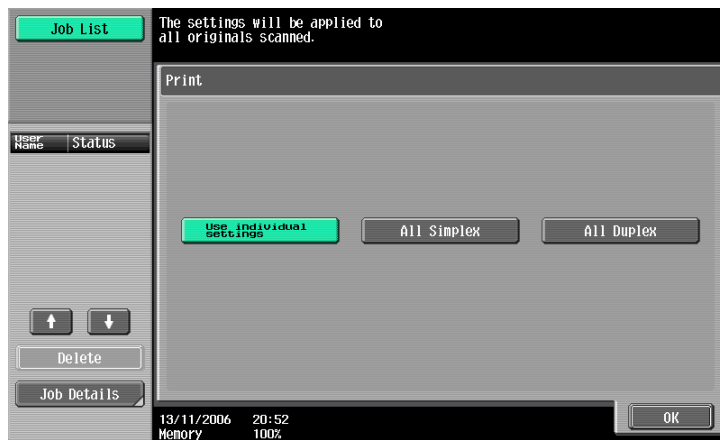

- ? Is there more information about the settings?
→ Refer to the appropriate section.

11 Using the keypad, type in the desired number of copies.

12 Touch [Start] or press the [Start] key.

- If [Cancel] is touched, a message appears, requesting confirmation to delete the data. To stop printing, touch [Yes], and then touch [OK].

7.7 Reversing black-and-white gradation of the original ("Neg./Pos. Reverse" function)

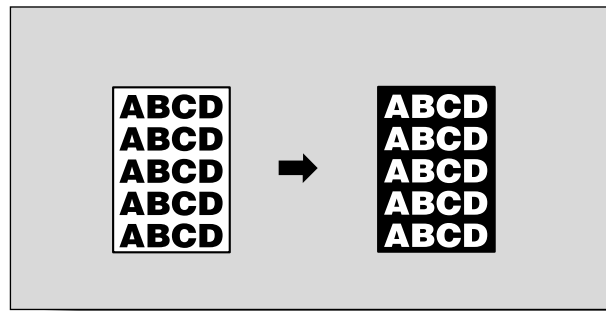

- 1 Position the original to be copied.
 - For details on positioning the original, refer to ["Feeding the original" on page 2-6](#).
- 2 Touch [Application].
 - To cancel changes to the settings for all Application functions, press the [Reset] key. All changes to the settings are canceled.

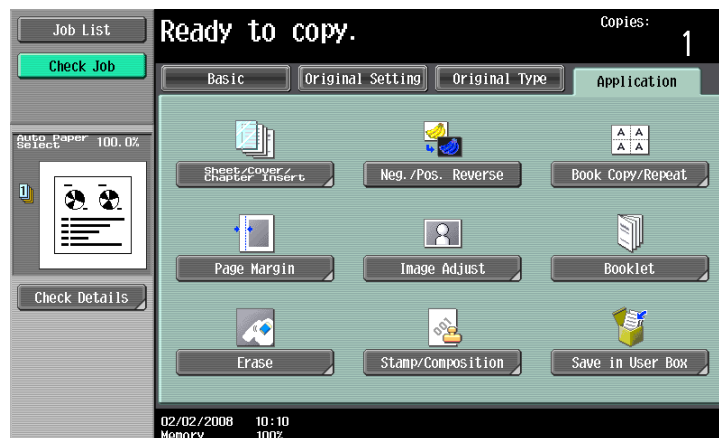

- 3 Touch [Neg./Pos. Reverse].

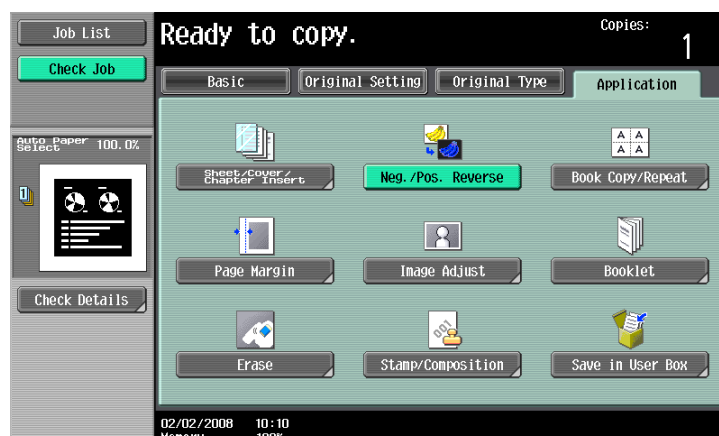

- ? To cancel the "Neg./Pos. Reverse" function
- Touch [Neg./Pos. Reverse] again.

- 4 Specify any other desired copy settings.
- 5 Using the keypad, type in the desired number of copies.

- 6 Press the [Start] key.

7.8 Producing separate copies of each page in a page spread ("Book Copy" function)

An open book or catalog can be copied with the left and right pages on separate sheets of paper. The following copy methods are available, and there are settings for adding front and back covers.

Setting	Description
Book Spread	Both pages of the page spread are printed on the same page.
Separation	Separate copies of each page in the page spread are printed in the original page order. The original is scanned to fit the size of paper that will be used.
Front Cover	The front cover and separate copies of each page in the page spreads are printed in the original page order.
Front and Back Cover	The front cover, separate copies of each page in the page spreads and the back cover are printed in the original page order.

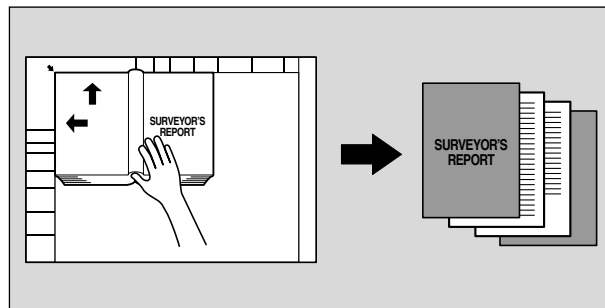

- ✓ Place the original on the original glass. Be sure to keep the ADF open throughout the scanning job.
- 1 Place the pages on the original glass, starting with the first page.
 - For details on positioning the original, refer to **"Feeding the original"** on page 2-6.
 - If "Front and Back Cover" was selected, the front cover is scanned before the back cover, and then all page spreads are scanned in order.

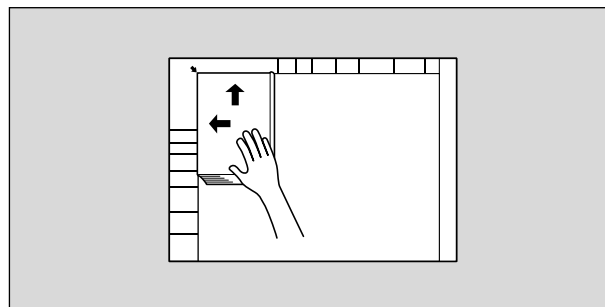

- ? How are the front and back covers copied?
 - Scan the front cover, then the back cover, and then scan the remainder of the original.

- 2 Load the paper to be used into the desired paper tray.

- 3 Touch [Application], and then touch [Book Copy/Repeat].
- To cancel changes to the settings for all Application functions, press the [Reset] key. All changes to the settings are canceled.

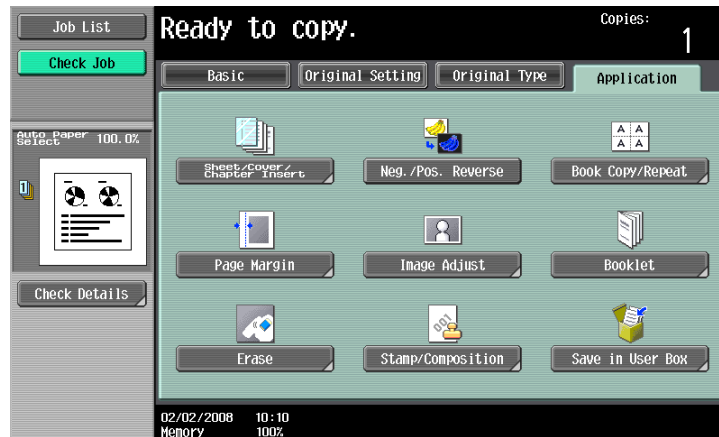

The Book Copy/Repeat screen appears.

- 4 Touch [Book Copy].

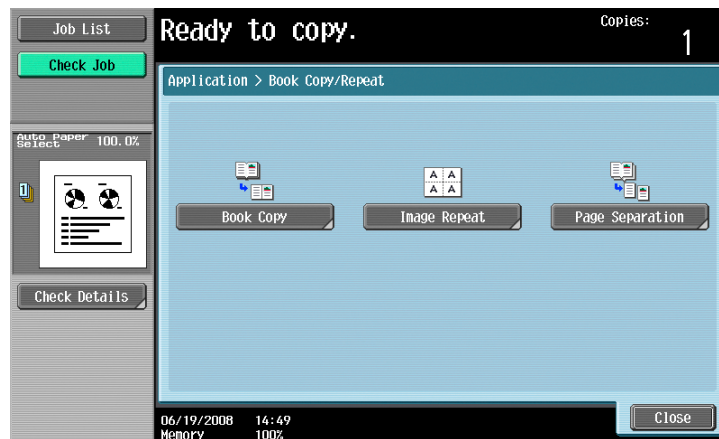

The Book Copy screen appears.

- 5 Touch the button for the desired setting.

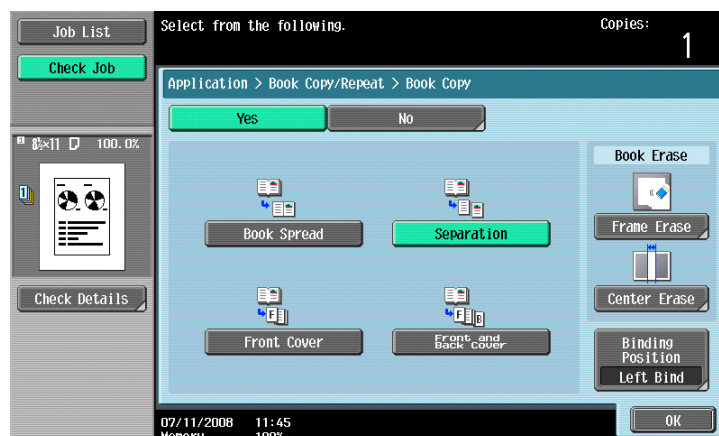

- If "Separation", "Front Cover" or "Front and Back Cover" is selected, [Binding Position] appears. Select the binding position of the original.
- If desired, specify a Book Erase function. Touch the button for the erasing method, touch [-] and [+] to specify the width of the area to be erased, and then touch "OK".
- Touch [←→] on the Frame Erase screen/Center Erase screen to switch between the integer and the fraction, specify the width to be erased, and then touch [OK].

- If a decimal value is displayed in the Frame Erase screen/Center Erase screen, use the keypad to type in the setting. For details on switching between decimal and fraction values, refer to "[System Settings](#)" on page 11-15.
- If a decimal value is displayed in the screen and the specified value is outside the allowable range, the message "Input Error" appears. Type a value within the allowable range. If the value was incorrectly entered, press the [C] (clear) key to erase the value, and then specify the correct value.
- To cancel the "Book Copy" function, touch [No].

Frame Erase screen

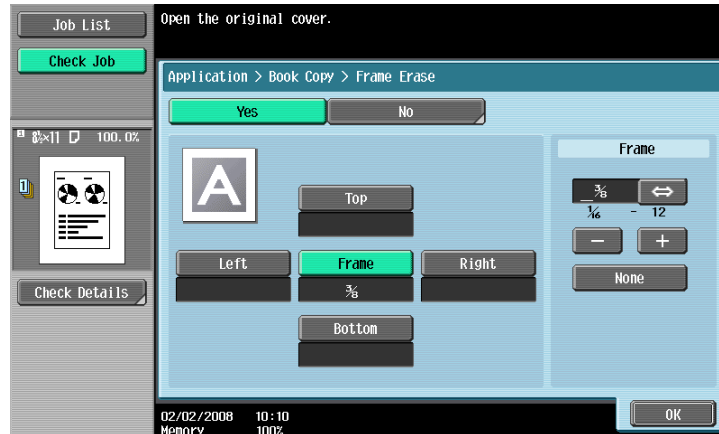

Center Erase screen



- ? What do the Book Erase functions do?
 - The shadow of the book binding and the shadow of the book edges can be erased from the copies. The "Frame Erase" and "Center Erase" functions can be used together.
- ? How are settings specified for the "Frame Erase" and "Center Erase" functions.
 - Refer to "[Erasing black marks along borders \("Erase" function\)](#)" on page 7-46. In addition, if the "Frame Erase" or "Center Erase" function in the Application screen is previously specified, [Frame Erase] or [Center Erase] under "Book Erase" appears highlighted.

- 6 Touch [OK], and then touch [Close].

- 7 In the Basic screen, touch [Paper], and then select the paper tray loaded with the paper.

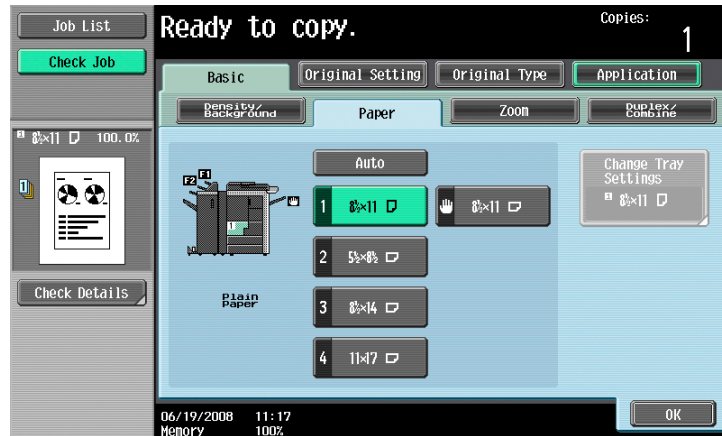

- 8 Specify any other desired copy settings.
- To cancel the setting and select the default, press the [Reset] key.
- 9 Using the keypad, type in the desired number of copies.
- 10 Press the [Start] key.
- For details on positioning the original, refer to ["Scanning a multi-page original from the original glass" on page 2-11](#).
 - Position the next page and repeat step 10 until all pages of the original are scanned.
- Scanning begins.
 If "Book Spread" or "Separation" is selected, printing begins.
 If "Front Cover" or "Front and Back Cover" is selected, continue with step 11.
- 11 After all original pages have been scanned, touch [Finish].
- If "Front and Back Cover" was selected, the back cover is scanned after the front cover, and then all page spreads are scanned in order.

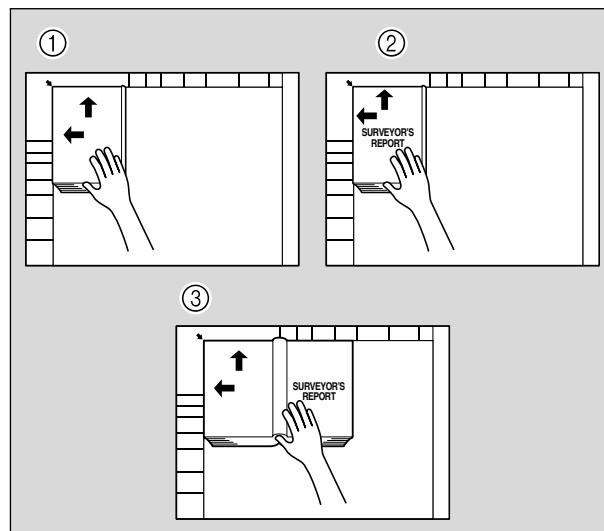

- If "Front Cover" was selected, all page spreads are scanned in order after the front cover.

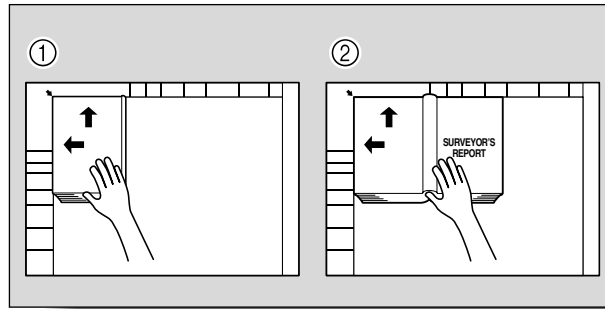

12 Press the [Start] key.

7.9 Tiling copy images ("Image Repeat" function)

An original image can be repeatedly printed on a single sheet of paper.

The possible number of repeating images is automatically selected based on the size of the loaded original, the specified paper size and the zoom ratio.

The following repeating formats and settings are available.

Setting	Description
With Margin	Multiple copies are printed of the entire image within the specified area. The area around the image appears as a margin.
Without Margin	Multiple copies of the selected area of the image are printed to fill the paper; however, a part of the image may be cut off.
2/4/8 Repeat	A fixed number of copies of the selected image area are printed in the paper. The number of repeating copies can be set to 2, 4 or 8 times. However, any part of the image that does not fit within its specific section of the paper is cut off.

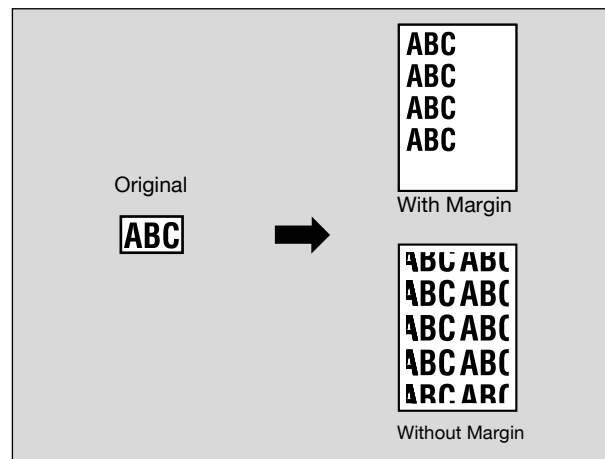

- 1 Position the original to be copied.
 - For details on positioning the original, refer to ["Feeding the original" on page 2-6](#).
- 2 Load the paper to be used into the desired paper tray.
- 3 Touch [Application], and then touch [Book Copy/Repeat].
 - To cancel changes to the settings for all Application functions, press the [Reset] key. All changes to the settings are canceled.

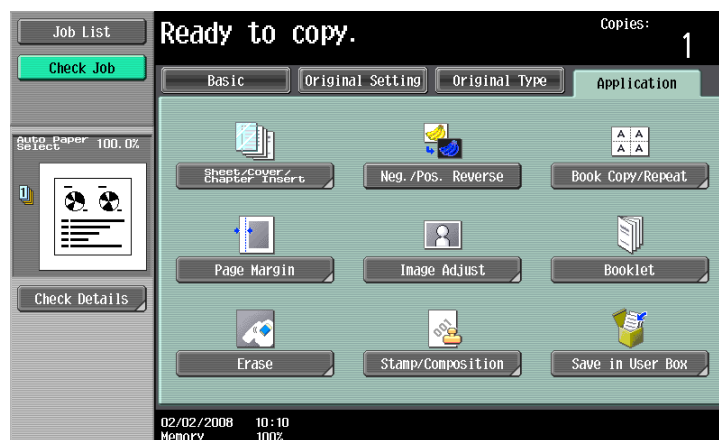

The Book Copy/Repeat screen appears.

4 Touch [Image Repeat].

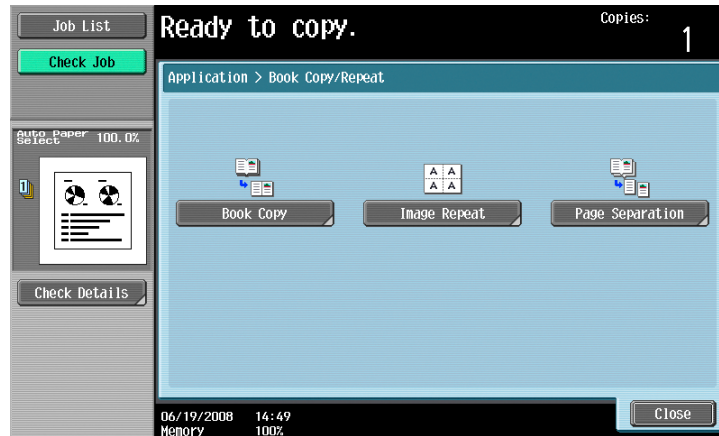

The Image Repeat screen appears.

- 5 Under "Layout", touch [With Margin] or [Without Margin], or touch [2/4/8 Repeat].
- To cancel the "Image Repeat" function, touch [No].

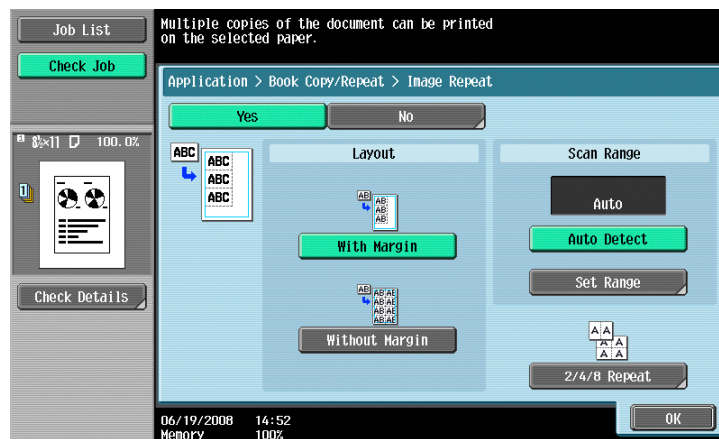

- Touching [2/4/8 Repeat] displays the 2/4/8 Repeat screen, where the number of repeats and the interval can be selected.
- When selecting [2 Repeat], touch [2 Repeat Detail Settings] to specify Image Direction and Repeat Interval Settings.

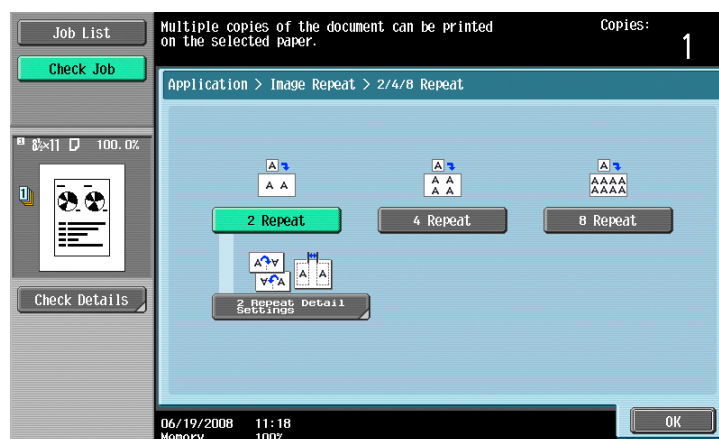



- 6 Check the scanning size under "Scan Range", touch [OK], and then touch [Close] in the next screen that appears.
- If the original size does not appear under "Scan Range" or to specify the scanning area, touch [Set Range], and then specify the scanning area from any of the screens.
 - To cancel changes to the settings, touch [Cancel].

Set Range screen



Custom Size screen

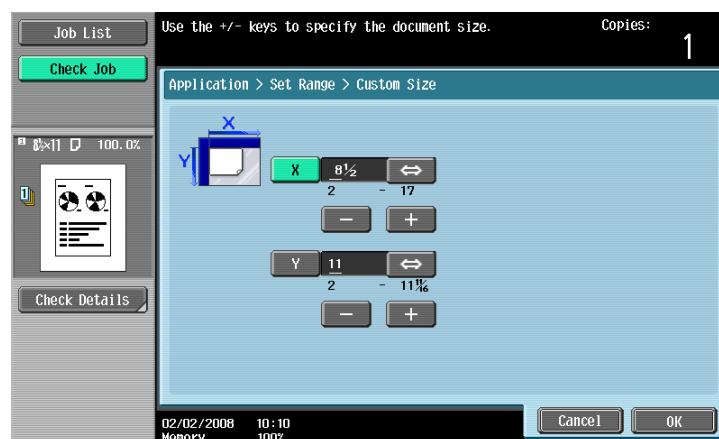

- ? Can sizes in metrics be displayed?
→ Touch [↑] or [↓] to display a different list of sizes.
- ? Can any size be specified?
→ Any size can be specified from the Custom Size screen. Touch [X] or [Y], touch [<-->] to switch between the integer and the fraction, and then touch [-] and [+] to specify the size of the document. If a decimal value is displayed in the screen, press the [C] (clear) key, and then use the keypad to

type in the setting. For details on switching between decimal and fraction values, refer to "[System Settings](#)" on page 11-15.

If a decimal value is displayed in the screen and the specified value is outside the allowable range, the message "Input Error" appears. Type a value within the allowable range. If the value was incorrectly entered, press the [C] (clear) key to erase the value, and then specify the correct value.

- 7 In the Basic screen, touch [Paper], and then select the paper tray loaded with the paper.

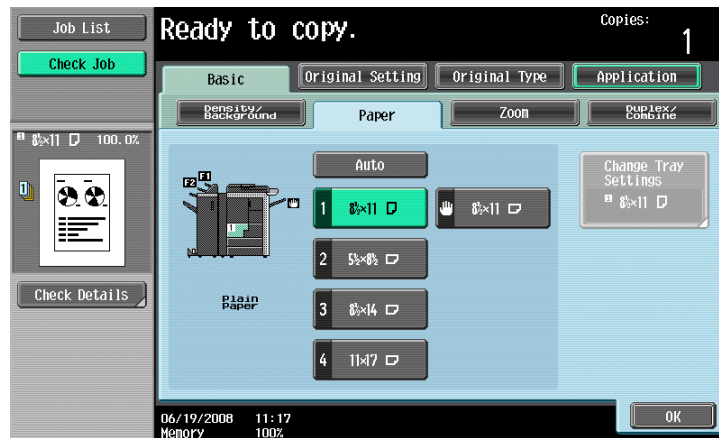

- If settings were specified in the 2/4/8 Repeat screen, touch [Zoom] in the Basic screen, and then specify the zoom ratio setting.

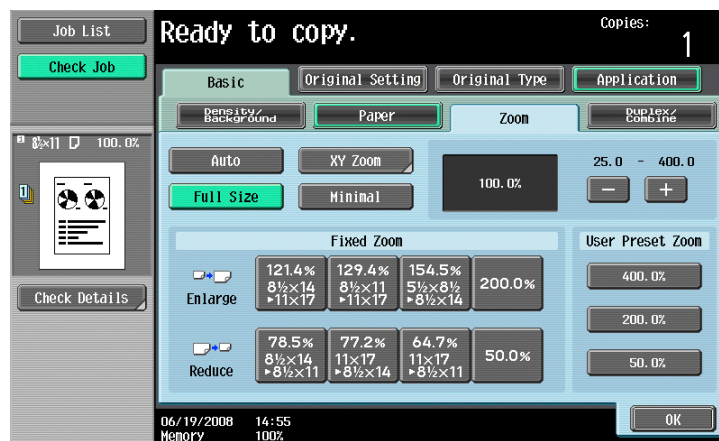





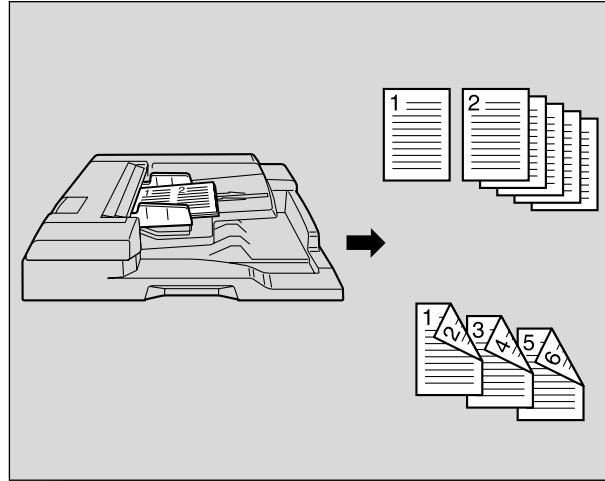

- 8 Specify any other desired copy settings.
- To cancel the setting and select the default, press the [Reset] key.
- 9 Using the keypad, type in the desired number of copies.
- 10 Press the [Start] key.

7.10 Dividing Spread Image into Right and Left Pages using ADF ("Page Separation" function)

A page spread image scanned from the ADF can be divided into two separate images of right and left pages.

A page spread image can be divided with the left and right halves copied onto separate pages. With single-sided copying, the two halves are printed on two separate pages. With double-sided copying, the two halves are printed on the front and back sides of a single page.



- 1 Load the original in the ADF.
 - For details on positioning the original, refer to **"Feeding the original" on page 2-6.**
 - For an original that exceeds 80 pages, refer to **"Scanning the original in separate batches ("Separate Scan" setting)" on page 2-8.**
- 2 Load paper of size A4 , B5 , and 8-1/2 x 11  into the desired paper tray.
 - Available paper sizes are A4 , B5 , and 8-1/2 x 11 . Auto Paper Select will not function.
- 3 Touch [Paper].



- 4 Touch the desired tray key to select the tray loaded with A4, B5, and 8-1/2 × 11 paper.

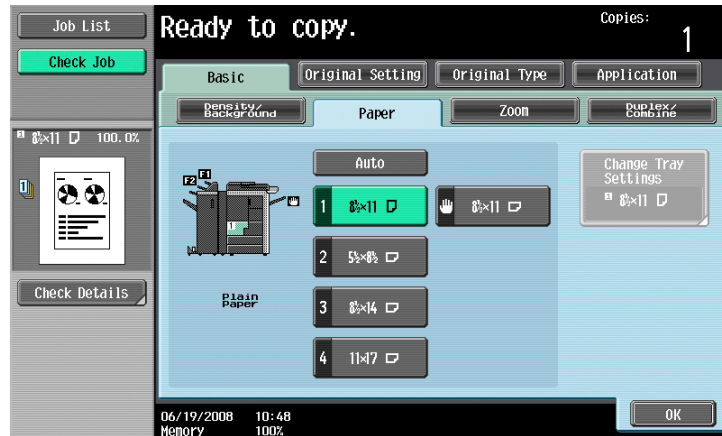

- 5 Touch [Application], and then touch [Book Copy/Repeat].
- To cancel changes to the settings for all Application functions, press the Reset key, All changes to the settings are canceled.



The Book Copy/Repeat screen appears.

- 6 Touch [Page Separation].

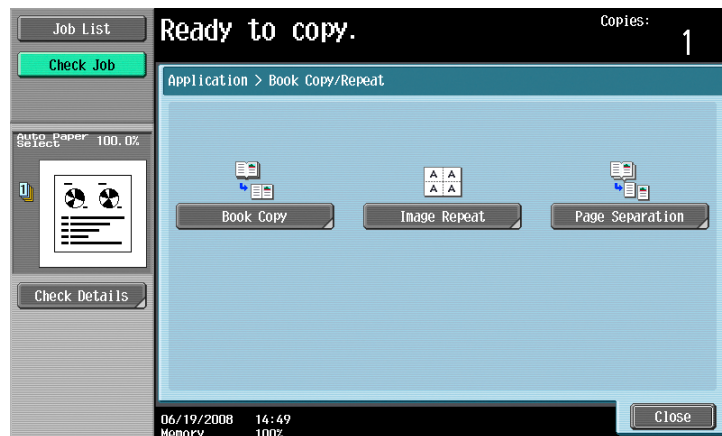

The Page Separation screen appears.

- 7 Select the binding position of the spread original.

- For the spread original to read from the left page to the right page, touch [Left Bind] to highlight it. On the contrary, if the spread original reads from the right page to the left page, touch [Right Bind].

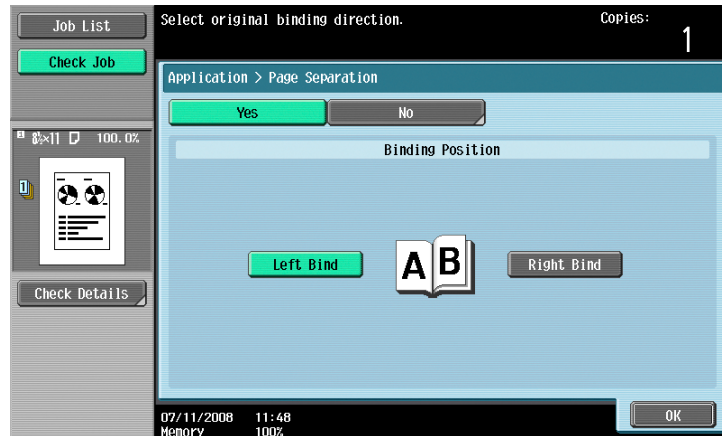

- 8 Touch [OK], and then touch [Close].
- 9 In the Basic screen, touch Paper, and then select the paper tray loaded with the paper.
- 10 Specify any other desired copy settings.
 - Auto Zoom will not function. The magnification can be changed as desired.
 - To cancel the setting and select the default press the [Reset] key.
- 11 Using the keypad, type in the desired number of copies.
- 12 Press the [Start] key.

7.11 Adding a binding margin to copies ("Page Margin" function)

Copies can be printed with a binding margin so that the pages can easily be filed. When making double-sided copies, the image orientation can be adjusted by specifying the position of the binding margin. In addition, the image orientation can be adjusted without creating a binding margin.

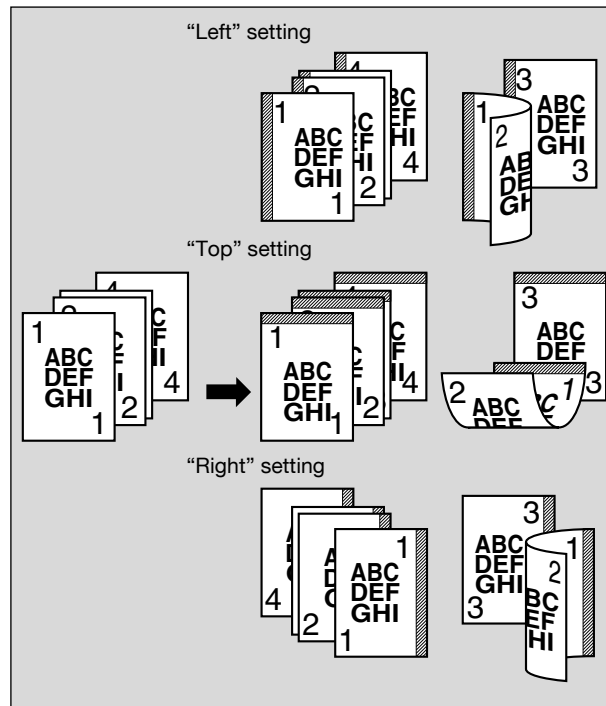

Detail

If the positions of the staples or punched holes are different from the binding position, the positions of the staples or punched holes are given priority.

- 1 Position the original to be copied.
 - For details on positioning the original, refer to "[Feeding the original](#)" on page 2-6.
- 2 Touch [Application], and then touch [Page Margin].
 - To cancel changes to the settings for all Application functions, press the [Reset] key. All changes to the settings are canceled.

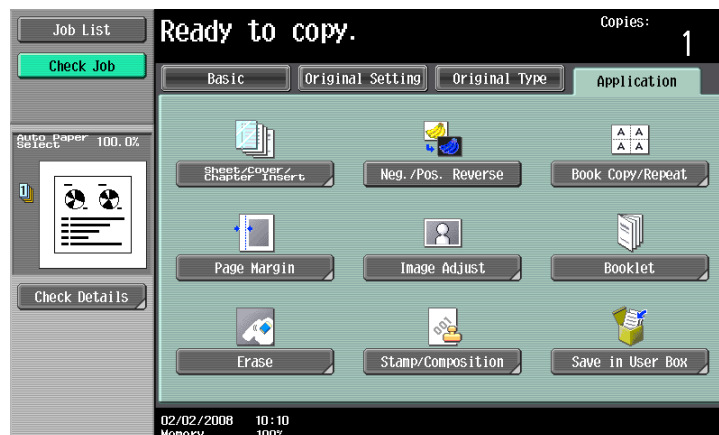

The Page Margin screen appears.

3 Select the position of the binding margin.

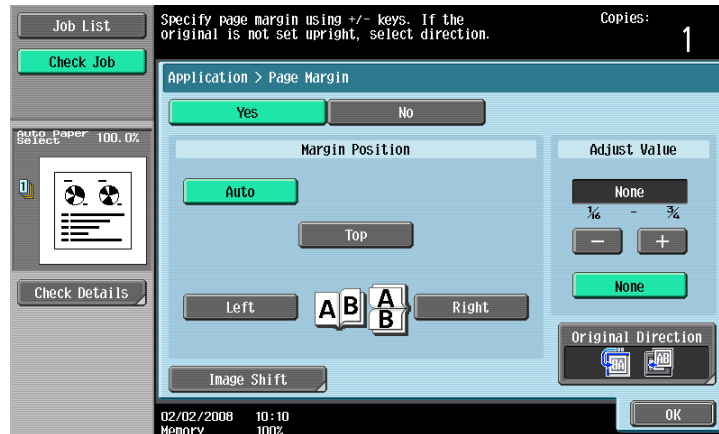

- To cancel the setting and select the default, press the [Reset] key.
- To cancel the "Page Margin" function, touch [No].
- If "Auto" is selected, the binding margin is set at the top or at the left.
- If "Auto" is selected for the binding position, load the original with the top toward the back of the machine. If the original is loaded in any other orientation, the correct position will not be selected.

? What happens when "Auto" is selected?

- The factory default setting is "Auto". Touch [Auto] to automatically determine the binding position according to the orientation of the loaded original. If the original length is 11-11/16 inch or less, a binding position along the long side of the paper is selected. If the original length is more than 11-11/16 inch, a binding position along the short side of the paper is selected.

4 Touch [-] or [+] to specify the binding margin width.

- If "None" is selected, the binding margin width is set to 0 inch. When making double-sided copies, the image orientation can be adjusted without creating a binding margin.
- If a decimal value is displayed in the screen, use the keypad to type in the setting. For details on switching between decimal and fraction values, refer to ["System Settings" on page 11-15](#).
- If a decimal value is displayed in the screen and the specified value is outside the allowable range, the message "Input Error" appears.
Type a value within the allowable range. If the value was incorrectly entered, press the [C] (clear) key to erase the value, and then specify the correct value.

? How can the entered margin position be corrected?

- Without changing the margin width, change the margin position.

5 If necessary, touch [Image Shift].

The Image Shift screen appears.

6 Adjust the position of the image, and then touch [OK].

- Touch [Left], [Right], [Top] or [Bottom] to select the direction to be adjusted, and then use the keypad or touch [-] and [+] to specify the adjustment amount.
- To cancel the shift, touch [No Shift].

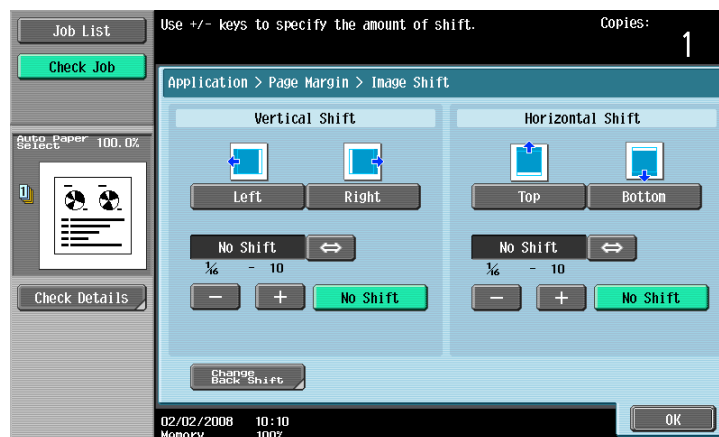

- To adjust the position of the image on the back side of the paper when printing double-sided copies, touch [Change Back Shift].

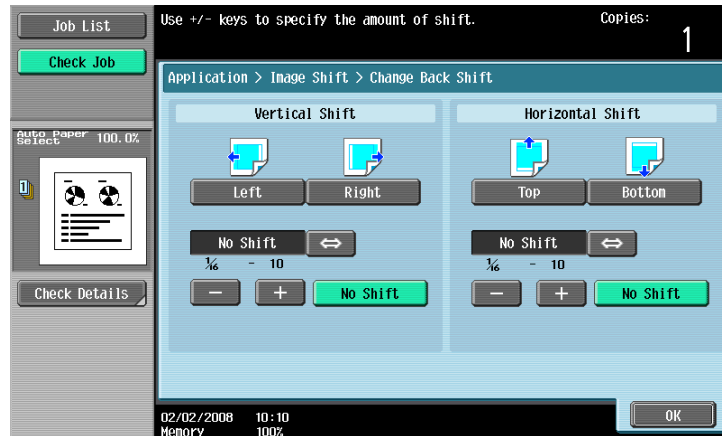

- 7 If desired, touch [Original Direction], and then select the setting appropriate for the original.
 - For details on specifying the original orientation, refer to ["Selecting the original orientation \(Original Direction settings\)" on page 2-22.](#)
- 8 Touch [OK].
- 9 Specify any other desired copy settings.
- 10 Using the keypad, type in the desired number of copies.
- 11 Press the [Start] key.

7.12 Adjusting the image to fit the paper ("Image Adjust" settings)

Use this function to make a copy adjusting the position of printed image.

The Centering function centers the original image on copy paper.

Setting	Description
Centering	The image is centered in the paper without being enlarged.
Full Scan	The full image is scanned without trimming to create margins. Even if text is printed to the edges of the original, it can be copied without being cut off.

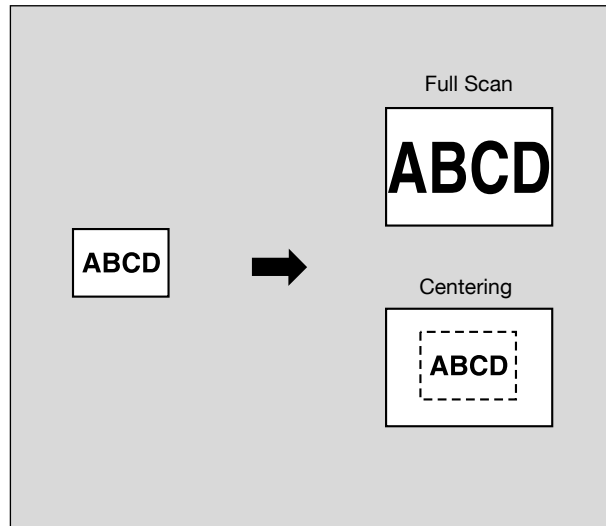

Detail

Normally, images are trimmed by 3 mm at the top, 4 mm at the bottom, and 2 mm on each side (left/right) from the paper size.

If [Full Scan] is selected, images are not trimmed but copied to the edge of the sheet.

- 1 Position the original to be copied.
 - For details on positioning the original, refer to ["Feeding the original" on page 2-6](#).
- 2 Touch [Application], and then touch [Image Adjust].
 - To cancel changes to the settings for all Application functions, press the [Reset] key. All changes to the settings are canceled.

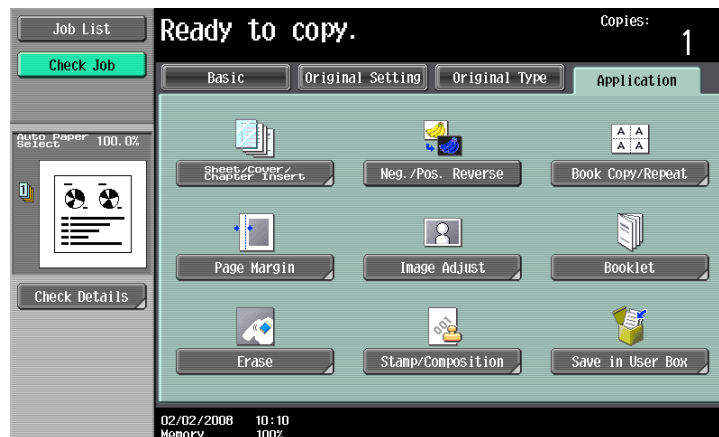

The Image Adjust screen appears.

- 3 Select the image adjusting method.

- To cancel the "Setting", touch [No].

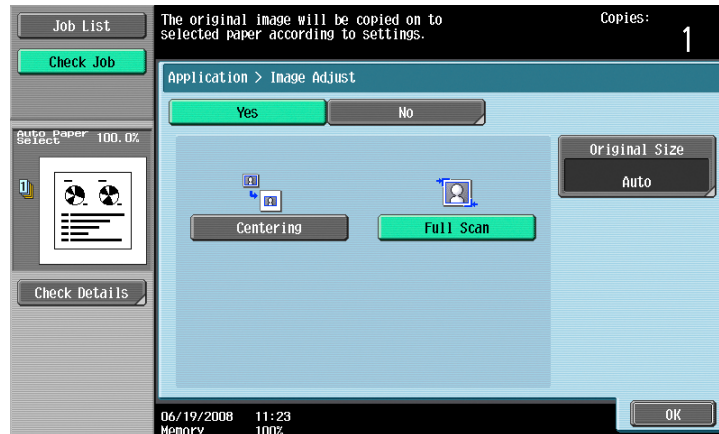

4 Check the original size, and then touch [OK].

- If the original size cannot be detected automatically or to specify the original size, touch [Original Size], and then specify the original size from any of the screens.

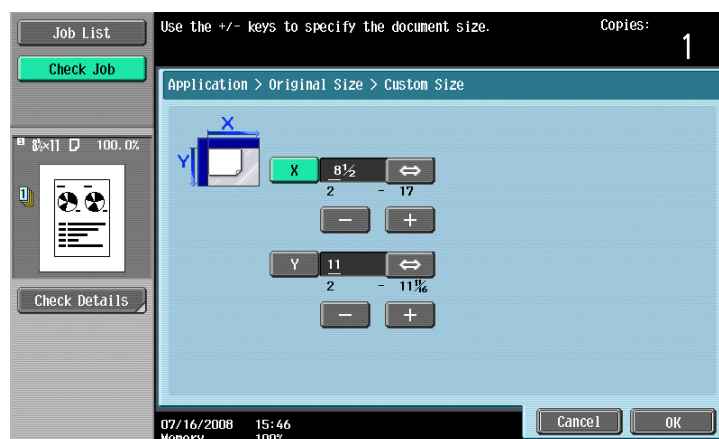

- Touch [↑] or [↓] to display a different list of standard sizes.
- To specify a custom size, touch [Custom Size] to display the Custom Size screen. Touch [X] or [Y] to select the dimension, and use the keypad to specify the desired value. (To enter a value, press the [C] (clear) key, and then use the keypad to type in the new value.)
- If a value outside the allowable range is specified, the message "Input Error" appears. If "Input Error" appeared or if the value was incorrectly entered, press the [C] (clear) key, and then specify the correct value.

5 Specify any other desired copy settings.

- To cancel the setting and select the default, press the [Reset] key.

6 Using the keypad, type in the desired number of copies.

- 7 Press the [Start] key.

7.13 Copying with the page layout of a booklet ("Booklet" function)

The page order of the scanned original is automatically arranged to produce double-sided copies in a page layout for center binding, such as for a magazine. Stapling is possible only when optional saddle stitcher on the finisher is installed.

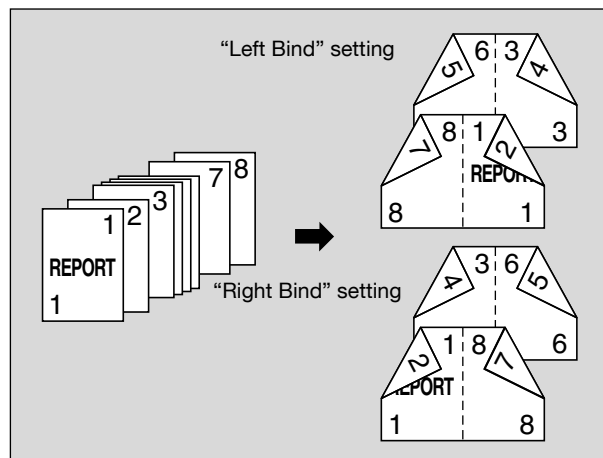

Detail

Generally, a multiple of 4 original pages is required with a single-sided original, and a multiple of 2 original pages is required with a double-sided original. If there are not enough pages, blank pages are automatically added at the end.

For details on stapling, refer to "[Binding copies at the center \("Center Staple & Fold" setting\)](#)" on [page 2-67](#).

For an original that exceeds 100 pages, refer to "[Scanning the original in separate batches \("Separate Scan" setting\)](#)" on [page 2-8](#).

The width of the binding margin is automatically specified.

- 1 Position the original to be copied.
 - For details on positioning the original, refer to "[Feeding the original](#)" on [page 2-6](#).
- 2 Touch [Application], and then touch [Booklet].
 - To cancel changes to the settings for all Application functions, press the [Reset] key. All changes to the settings are canceled.

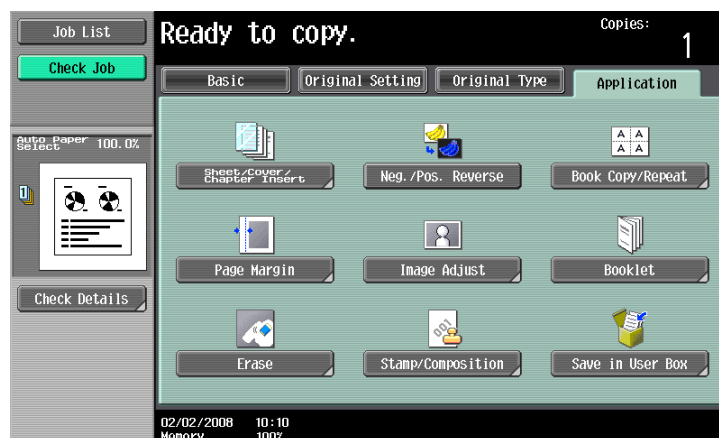

3 Touch [Left Bind] or [Right Bind].

- If the original contains only pages in the landscape orientation, they will be bound at the top, regardless of which setting is selected.
- To cancel the setting and select the default, press the [Reset] key.
- To cancel the "Booklet" function, touch [No].

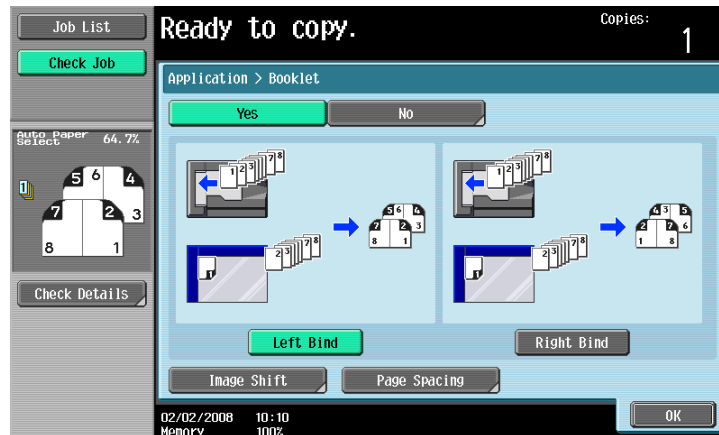

- To adjust the image position widthwise and lengthwise as desired, touch [Image Shift], specify the shift amount, then touch [OK].
- For details of shift amount setting, refer to ["Adding a binding margin to copies \("Page Margin" function\)" on page 7-36.](#)

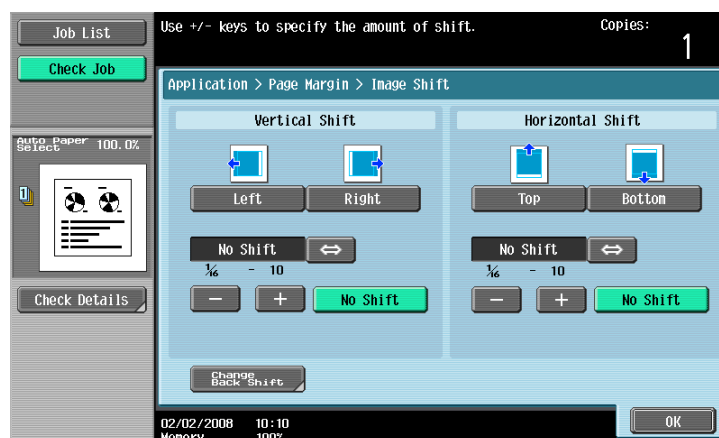

- To make the specified amount of blank space in the center between the two images on a page, touch [Page Spacing]. Select [Front/Back] to make the same amount of blank space, or [Front Side]/[Back Side] to specify the different amount for each, then use [-], [+], or control panel keypad to enter the desired amount. Touch [OK] to complete the setting.

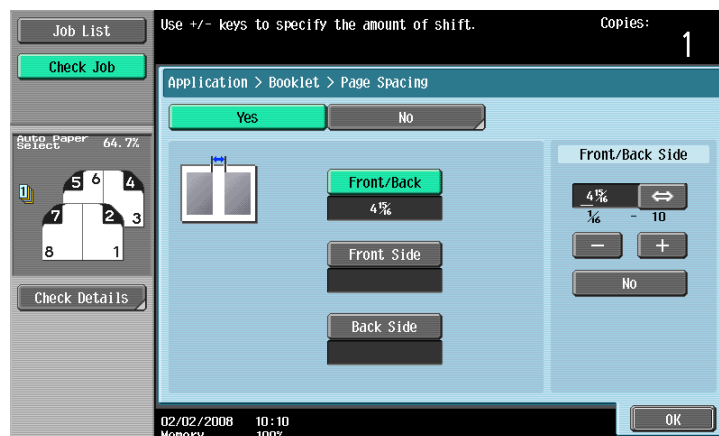

4 Touch [OK].

- 5 Specify any other desired copy settings.
- 6 Using the keypad, type in the desired number of copies.
- 7 Press the [Start] key.

7.14 Erasing specified area of copies (Erase)

When the original is scanned from the original glass, black copy marks may be produced along borders and center line, and also around punch holes.

Use this function to eliminate them from the copies and lower the toner consumption at the same time.

The following three settings are provided for the Erase function. These are compatible with each other.

Setting	Description
Frame Erase	This function erases black marks along the borders of printed sheets which tend to be created when using the original glass to scan thick original such as a book. Use this function also for the original already having black marks along borders. Refer to "Erasing black marks along borders ("Erase" function)" on page 7-46
Center Erase	This function erases black marks along the center fold of printed sheets which tend to be created when using the original glass to scan thick original such as a book. Use this function also for the original already having black marks along the center fold. Refer to "Erasing black marks along center fold ("Center Erase" function)" on page 7-47
Non-Image Area Erase	This function detects the original size placed on the original glass and erases outside area of the original. Refer to "Erasing outside areas of the original ("Non-Image Area Erase" function)" on page 7-50

Frame Erase

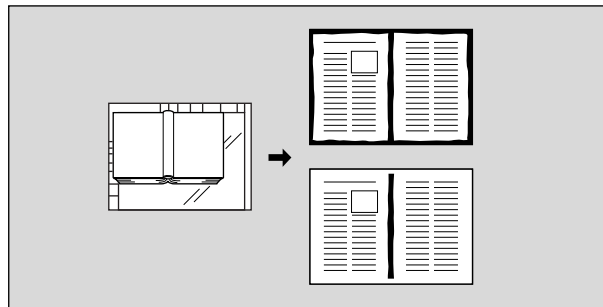

Center Erase

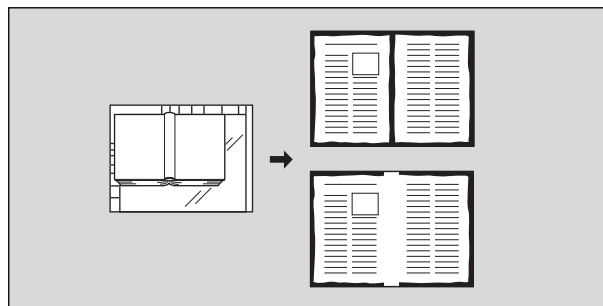

Non-Image Area Erase

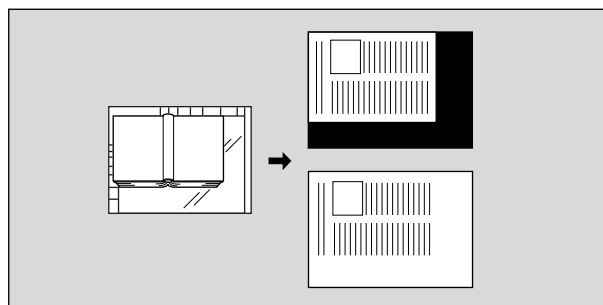

7.14.1 Erasing black marks along borders ("Erase" function)

Copies can be produced by erasing unwanted areas around the original, such as the transmission information on received faxes and the shadows of punched holes.

With frame erasing, the same width can be erased along all four sides of the original or a different width can be erased along each side of the original.

- 1 Position the original to be copied.
 - For details on positioning the original, refer to ["Feeding the original" on page 2-6](#).
- 2 Touch [Application], and then touch [Erase].
 - To cancel changes to the settings for all Application functions, press the [Reset] key. All changes to the settings are canceled.

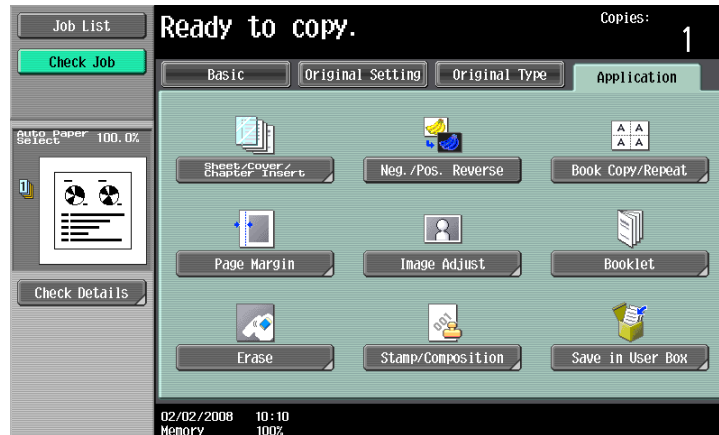

The Erase screen appears.

- 3 Touch [Frame Erase].

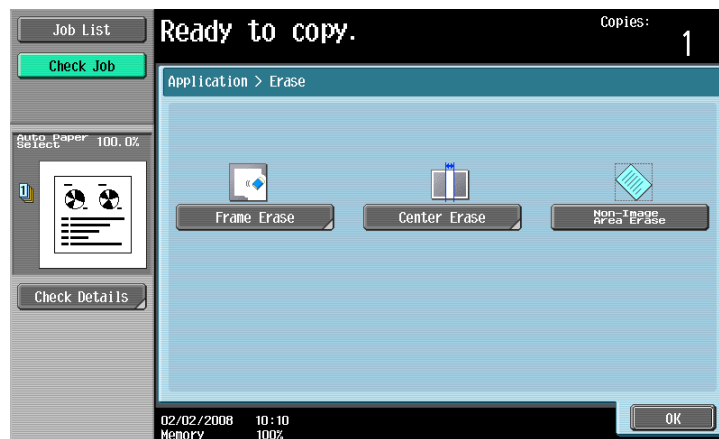

The Frame Erase screen appears.

- 4 Touch the button for the desired position to be erased.



- To cancel the setting and select the default, press the [Reset] key.
- To cancel the "Frame Erase" function, touch [No].

? What happens when [Frame] is selected?

→ The same width is erased on all four sides of the original. The factory default setting is "Frame".

? Can the settings be combined?

→ "Frame" cannot be combined with the other settings ("Top", "Left", "Right" or "Bottom").

- 5 Touch [<->] to switch between the integer and the fraction, and then touch [-] and [+] to specify the width to be erased.

- To specify a different width to be erased depending on the position, specify different settings for "Top", "Left", "Right", and "Bottom".
- When using the keypad to specify the settings, press the [C] (clear) key, and then specify the setting.
- If a decimal value is displayed in the screen, press the [C] (clear) key, and then use the keypad to type in the setting. For details on switching between decimal and fraction values, refer to "[System Settings](#)" on page 11-15.
- If a decimal value is displayed in the screen and the specified value is outside the allowable range, the message "Input Error" appears.
Type a value within the allowable range. If the value was incorrectly entered, press the [C] (clear) key to erase the value, and then specify the correct value.

- 6 Touch [OK].

- 7 Specify any other desired copy settings.

- 8 Using the keypad, type in the desired number of copies.

- 9 Press the [Start] key.

7.14.2 Erasing black marks along center fold ("Center Erase" function)

This function erases black marks along the center fold of printed sheets which tend to be created when using the original glass to scan thick original such as a book.
Use this function also for the original already having black marks along the center fold.

With frame erasing, the same width can be erased along all four sides of the original or a different width can be erased along each side of the original.

- 1 Position the original to be copied.

- For details on positioning the original, refer to "[Feeding the original](#)" on page 2-6.

- 2 Touch [Application], and then touch [Erase].
 - To cancel changes to the settings for all Application functions, press the [Reset] key. All changes to the settings are canceled.

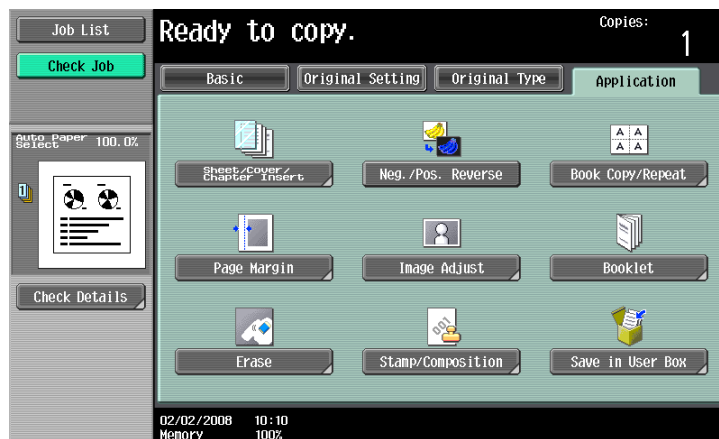

The Erase screen appears.

- 3 Touch [Center Erase].

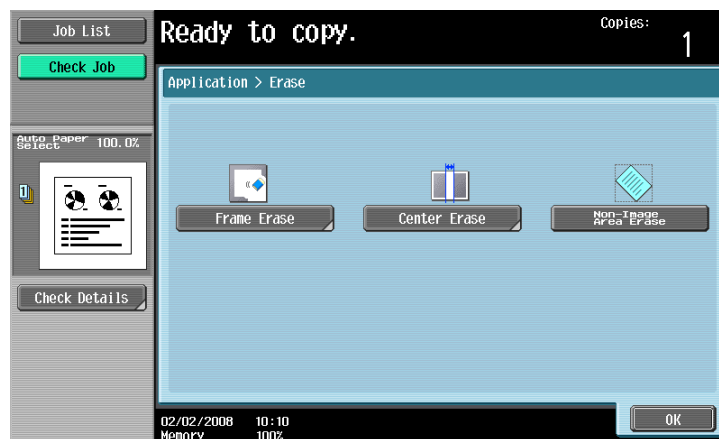

The Center Erase screen appears.

- 4 Touch [<->] to switch between the integer and the fraction, and then touch [-] and [+] to specify the width to be erased.



- When using the keypad to specify the settings, press the [C] (clear) key, and then specify the setting.
 - To cancel the setting and select the default, press the [Reset] key.
 - To cancel the "Center Erase" function, touch [No].
- ? What happens when a value outside of the allowable range is specified?
- The message "Input error" appears. If "Input error" appears or if the erased width was incorrectly entered, press the [C] (clear) key in the keypad, and then specify the correct value.

- 5 Touch [OK].
- 6 Specify any other desired copy settings.
- 7 Using the keypad, type in the desired number of copies.
- 8 Press the [Start] key.

7.14.3 Erasing outside areas of the original ("Non-Image Area Erase" function)

This function detects the original size placed on the original glass and erases outside areas of the original.

- 1 Position the original to be copied.
 - For details on positioning the original, refer to **"Feeding the original" on page 2-6**.
- 2 Touch [Application], and then touch [Erase].
 - To cancel changes to the settings for all Application functions, press the [Reset] key. All changes to the settings are canceled.

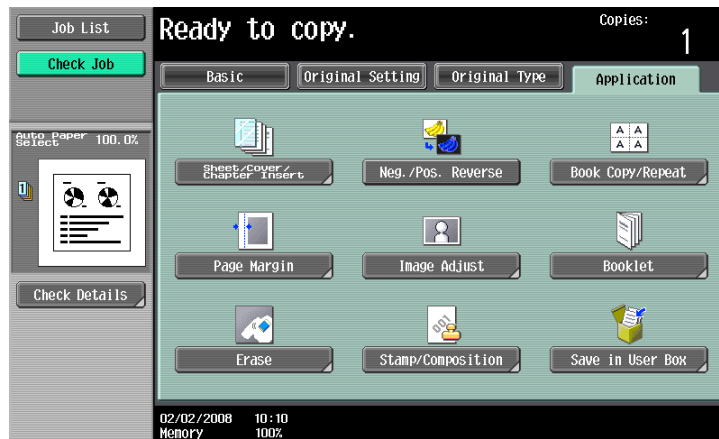

The Erase screen appears.

- 3 Touch [Non-Image Area Erase], then touch [OK].

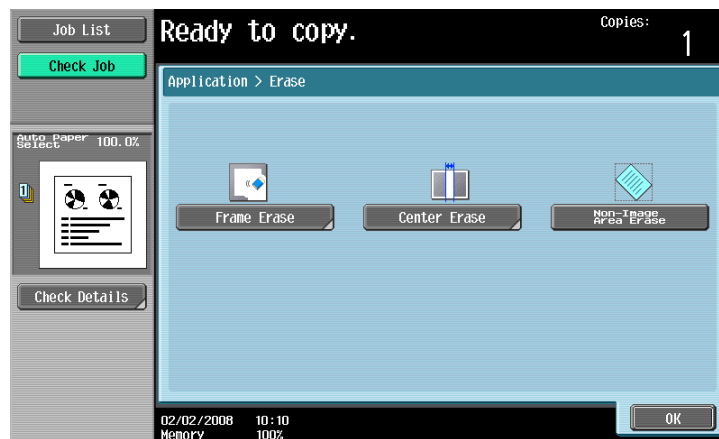

- To cancel the setting and select the default, press the [Reset] key.
- To cancel the "Non-Image Area Erase" function, touch the key again.

- 4 Specify any other desired copy settings.
- 5 Using the keypad, type in the desired number of copies.
- 6 Press the [Start] key.

7.15 Printing the date/time or page number on copies (Stamp/Composition functions)

The date/time or page number can be added to copies at the specified location, or a distribution number can be added when multiple copies are made.

The following Stamp/Composition functions are available and can be combined.

Function	Description
Date/Time	Select a format and print the date or time on the specified pages.
Page Number	Select a format and print page numbers starting with the specified page number.
Stamp	<ul style="list-style-type: none"> Preset Stamp Print copies with previously stored preset stamps overlapping pages. Registered Stamp Print copies with a stamp registered with the Copy Protection Utility overlapping pages.
Stamp Repeat	Print copies with text (such as registered stamps, preset stamps or the date) repeating throughout the page.
Overlay	Copies can be printed with the contents of the first original page overlapped by (as an overlay image) the remaining original pages.
Registered Overlay	A previously scanned image can be stored on the HDD (Register Overlay Image) and recalled when needed to printed overlapping a document (Recall Overlay Image).
Header/Footer	The date and time or a distribution number can be printed on each page. This function is available only when specified by the administrator.
Distribution Control Number	Print four-digit distribution number to fill the background of each copied set.
Watermark	Print the desired letter type selected from preset watermarks in the center of printed page background.

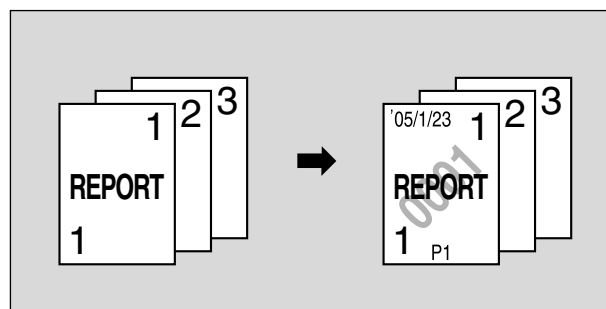

Detail

The [Registered Overlay] key appears only when the machine is equipped with in HDD.

To use Header/Footer function, a header/footer should be registered in advance from Administrator mode.

For details on registering headers/footers, refer to "[Specifying headers/footers](#)" on page 11-56.



Detail

For details on printing a date/time stamp, refer to [page 7-52](#).

For details on printing a page number stamp, refer to [page 7-55](#).

For details on printing a stamp, refer to [page 7-58](#).

For details on printing a repeating stamp, refer to [page 7-61](#).

For details on printing an overlay, refer to [page 7-65](#).

For details on printing a registered overlay, refer to [page 7-67](#).

For details on printing a header/footer, refer to [page 7-71](#).

For details on printing a distribution control number, refer to [page 7-73](#).

For details on printing a watermark, refer to [page 7-75](#).

7.15.1 Printing the date/time ("Date/Time" function)

- 1 Position the original to be copied.
 - For details on positioning the original, refer to ["Feeding the original" on page 2-6](#).
- 2 Touch [Application], and then touch [Stamp/Composition].
 - To cancel changes to the settings for all Application functions, press the [Reset] key. All changes to the settings are canceled.

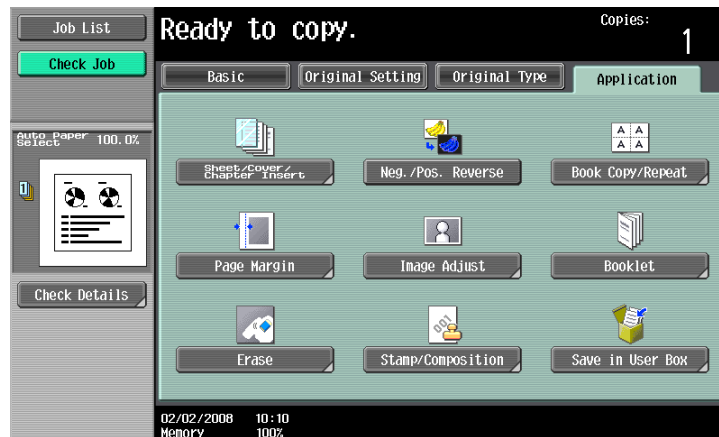

The Stamp/Composition screen appears.

- 3 Touch [Date/Time].

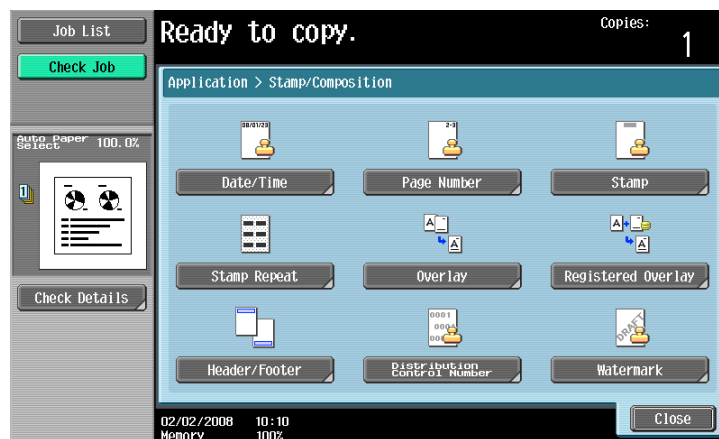

The Date/Time screen appears.

- 4 Touch buttons under "Date Format", "Time Format" and "Pages" to specify the various settings.

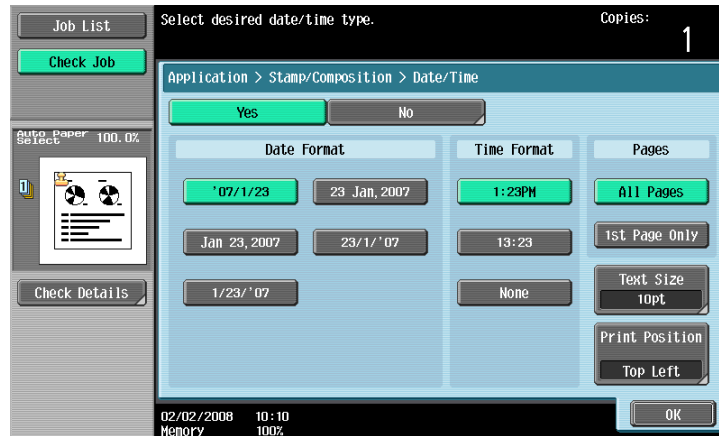

- To cancel the "Date/Time" function, touch [No].
- To print the date/time only on the first page, touch [1st Page Only].
- The stamp will not be printed on blank pages inserted using the "Cover Sheet", "Insert Sheet" and "Chapters" functions.

? Can the time be omitted?

→ If "None" is selected, the time is not printed.

- 5 Touch [Print Position], and then select the printing position.



- To make fine adjustments to the printing position, touch [Adjust Position]. Select the desired direction under "Left & Right Adjustment" or "Top & Bottom Adjustment", touch [] to switch between the integer and the fraction, touch [-] and [+] to specify the adjustment amount, and then touch [OK].
- If a decimal value is displayed in the screen, press the [C] (clear) key, and then use the keypad to type in the adjustment amount. For details on switching between decimal and fraction values, refer to ["System Settings" on page 11-15](#).

- If a decimal value is displayed in the screen and the specified value is outside the allowable range, the message "Input Error" appears.
Type a value within the allowable range. If the value was incorrectly entered, press the [C] (clear) key to erase the value, and then specify the correct value.

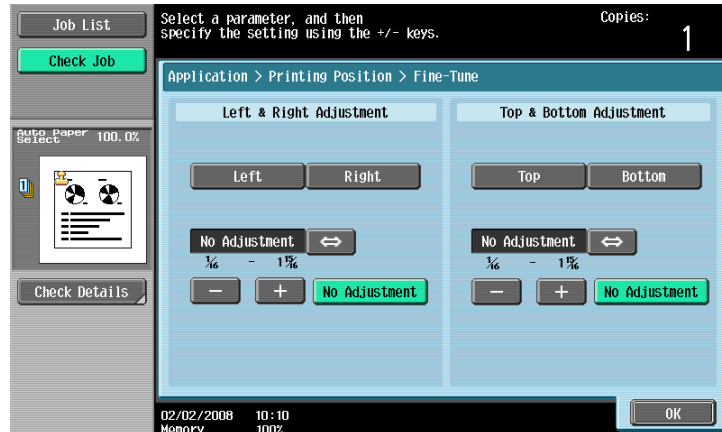

- ? What are the limits on the adjustment amount?
→ The print position can be finely adjusted in 1/16 inch increments.
- ? Can no adjustments be made?
→ To make no left/right or up/down adjustments, touch [No Adjustment].

6 If necessary, specify the other settings.

- To specify the text size, touch [Text Size], and then select the size. The factory default is 10 pt.

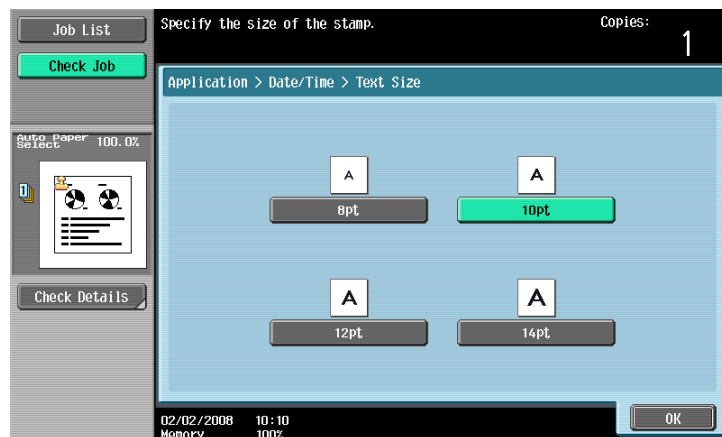

- 7 Touch [OK], and then touch [Close] in the next screen that appears.
- 8 Specify any other desired copy settings.
 - To cancel the setting and select the default, press the [Reset] key.
- 9 Using the keypad, type in the desired number of copies.
- 10 Press the [Start] key.

7.15.2 Printing the page number ("Page Number" function)

- 1 Position the original to be copied.
 - For details on positioning the original, refer to "Feeding the original" on page 2-6.
- 2 Touch [Application], and then touch [Stamp/Composition].
 - To cancel changes to the settings for all Application functions, press the [Reset] key. All changes to the settings are canceled.

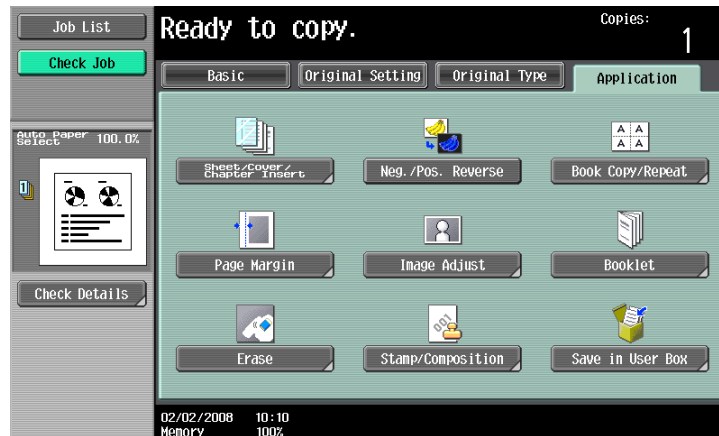

The Stamp/Composition screen appears.

- 3 Touch [Page Number].

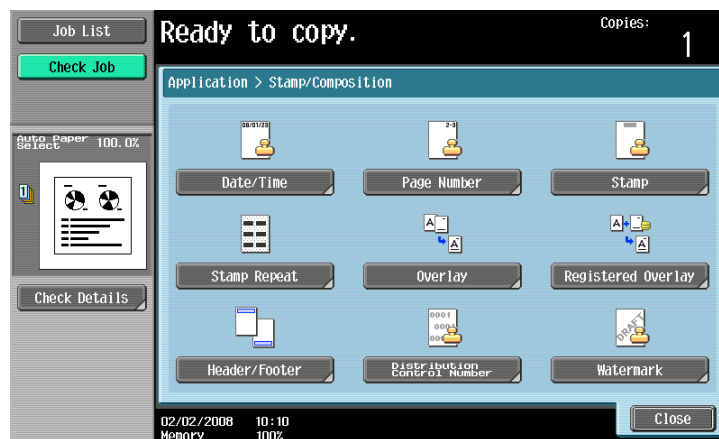

The Page Number screen appears.

- 4 Using the keypad, type in the starting page number for printing.

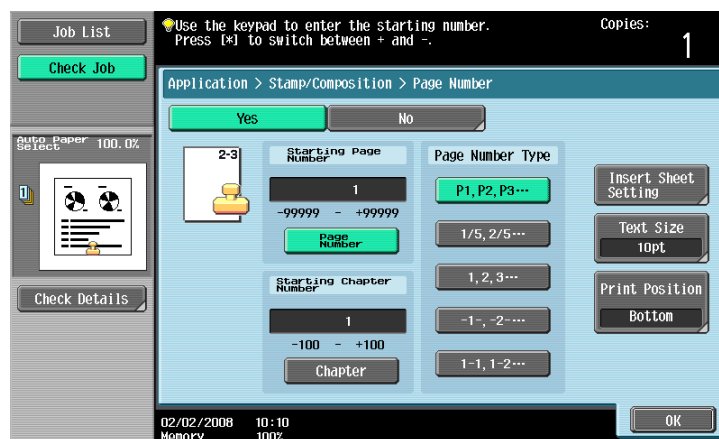

- If desired, touch [Chapter], and then use the keypad to type in the chapter number. The entered chapter number is printed if "1-1, 1-2...." is selected under "Page Number Type".

- The setting for "Page Number" can be set to a number between -99999 and 99999, and the setting for "Chapter" can be set to a number between -100 and 100.
- When specifying a setting for "Starting Page Number", switch the number between positive and negative by pressing the [\times] key.
- If a negative value is specified, the numbers are not printed until the numbering reaches 1. For example, if "-1" was specified, the numbers are printed starting with "1" on the third copied page.
- To print multiple chapters, specify the first page of each chapter using the "Chapters" function. For details, refer to ["Specifying pages to be printed on the front side \("Chapters" function\)" on page 7-15](#).
- To cancel the "Page Number" function, touch [No].

5 Select a setting under "Page Number Type".

6 Touch [Print Position], and then select the printing position.

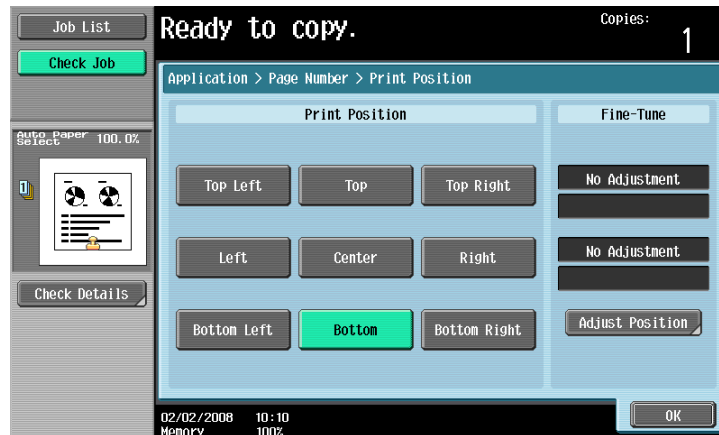

- To make fine adjustments to the printing position, touch [Adjust Position]. Select the desired direction under "Left & Right Adjustment" or "Top & Bottom Adjustment", touch [] to switch between the integer and the fraction, touch [-] and [+] to specify the adjustment amount, and then touch [OK].
- If a decimal value is displayed in the screen, press the [C] (clear) key, and then use the keypad to type in the adjustment amount. For details on switching between decimal and fraction values, refer to ["System Settings" on page 11-15](#).
- If a decimal value is displayed in the screen and the specified value is outside the allowable range, the message "Input Error" appears. Type a value within the allowable range. If the value was incorrectly entered, press the [C] (clear) key to erase the value, and then specify the correct value.

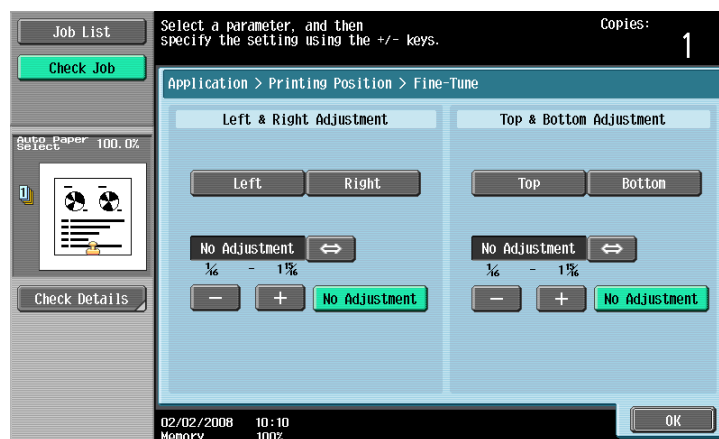

- ? What are the limits on the adjustment amount?
→ The print position can be finely adjusted in 1/16 inch increments.
- ? Can no adjustment be made?
→ To make no left/right or up/down adjustments, touch [No Adjustment].

7 If necessary, specify the other settings.

- To also specify settings for the "Cover Sheet", "Insert Sheet" and "Chapters" Application functions, touch [Insert Sheet Setting], and then select the settings for the pages to be printed.



- Blank pages inserted using the "Cover Sheet", "Insert Sheet" and "Chapters" functions are only counted, but page numbers are not printed on them.
- If "Print on Back Cover Only" or "Do Not Print Page Number" is selected under "Cover Sheet", page numbers are printed starting with "2" in single-sided copies and starting with "3" in double-sided copies.
- If "Do Not Print #" is selected, inserted pages are only counted, but page numbers are not printed on them. If "Skip the Page(s)" is selected, inserted pages are not counted and page numbers are not printed on them.
- To specify the text size, touch [Text Size], and then select the size. The factory default is 10 pt.

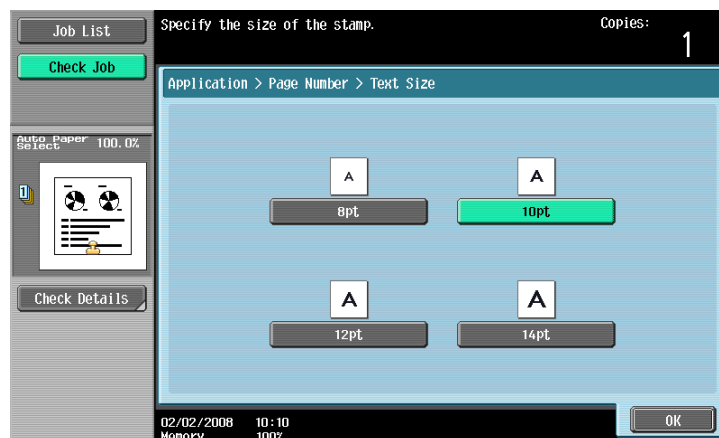

- 8 Touch [OK], and then touch [Close] in the next screen that appears.
- 9 Specify any other desired copy settings.
 - To cancel the setting and select the default, press the [Reset] key.
- 10 Using the keypad, type in the desired number of copies.
- 11 Press the [Start] key.

7.15.3 Printing previously registered stamps ("Stamp" function)

- 1 Position the original to be copied.
 - Use the Copy Protection Utility to register a registered stamp. For details on registering stamps, refer to the manual of the Copy Protection Utility.
 - For details on positioning the original, refer to **"Feeding the original" on page 2-6**.
- 2 Touch [Application], and then touch [Stamp/Composition].
 - To cancel changes to the settings for all Application functions, press the [Reset] key. All changes to the settings are canceled.

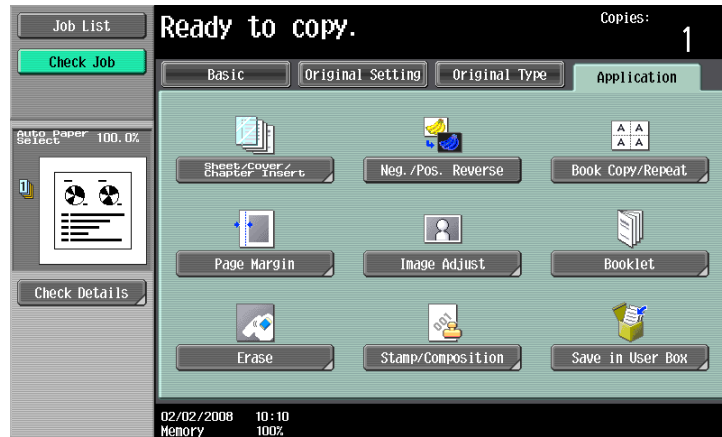

The Stamp/Composition screen appears.

- 3 Touch [Stamp].
 - To cancel the "Stamp" function, touch [No].

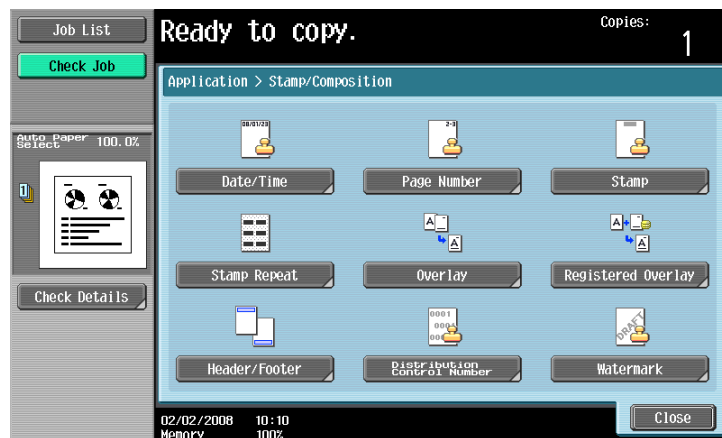

The Stamp screen appears.

- 4 Select the desired stamp under "Stamp Type/Preset Stamps" or "Stamp Type/Registered Stamps".

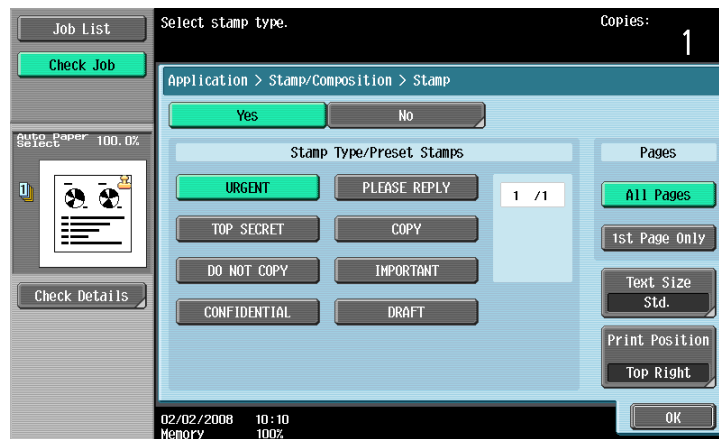

- Touch [↑] or [↓] to display a different list of preset or registered stamps.
- Only one stamp can be selected.

- 5 Select the desired setting under "Pages".

- To print the stamp only on the front cover, touch [1st Page Only].
- The stamp will not be printed on blank pages inserted using the "Cover Sheet", "Insert Sheet" and "Chapters" functions.

- 6 Touch [Print Position], and then select the printing position.

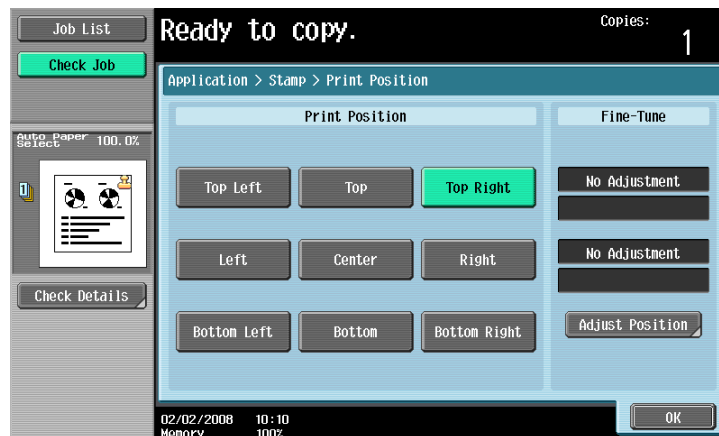

- To make fine adjustments to the printing position, touch [Adjust Position]. Select the desired direction under "Left & Right Adjustment" or "Top & Bottom Adjustment", touch [] to switch between the integer and the fraction, touch [-] and [+] to specify the adjustment amount, and then touch [OK].
- If a decimal value is displayed in the screen, press the [C] (clear) key, and then use the keypad to type in the adjustment amount. For details on switching between decimal and fraction values, refer to ["System Settings" on page 11-15](#).

- If a decimal value is displayed in the screen and the specified value is outside the allowable range, the message "Input Error" appears.
Type a value within the allowable range. If the value was incorrectly entered, press the [C] (clear) key to erase the value, and then specify the correct value.

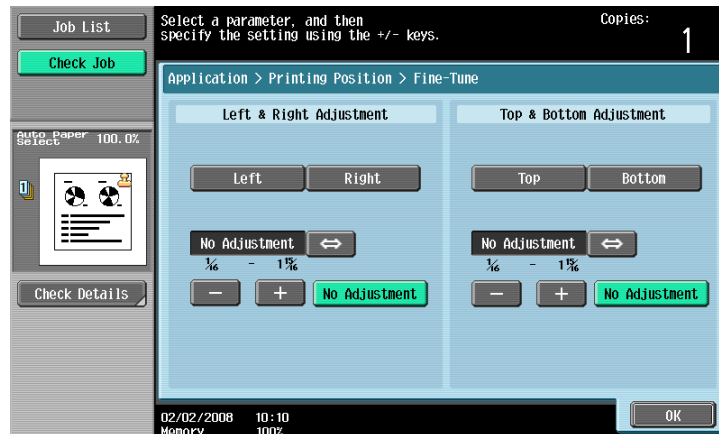

- ? What are the limits on the adjustment amount?
→ The print position can be finely adjusted in 1/16 inch increments.
- ? Can no adjustments be made?
→ To make no left/right or up/down adjustments, touch [No Adjustment].

7 Select the desired settings for "Text Size".

- As the factory default, the following setting is selected.
Text Size: Std.

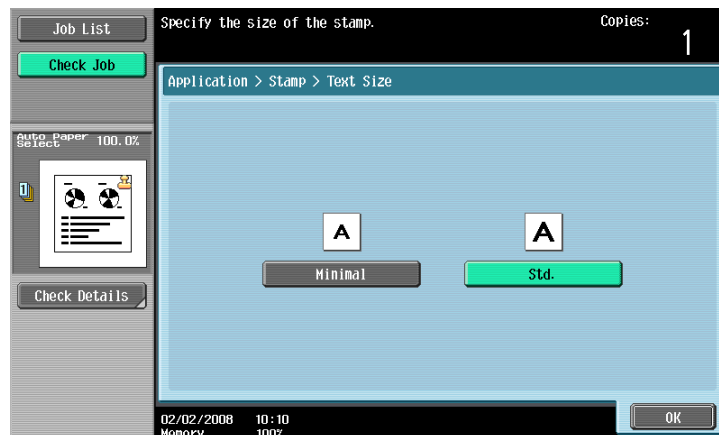

- 8 Touch [OK], and then touch [Close] in the next screen that appears.
- 9 Specify any other desired copy settings.
- 10 Using the keypad, type in the desired number of copies.
- 11 Press the [Start] key.

7.15.4 Printing repeating stamps ("Stamp Repeat" function)

- 1 Position the original to be copied.
 - For details on positioning the original, refer to "Feeding the original" on page 2-6.
- 2 Touch [Application], and then touch [Stamp/Composition].
 - To cancel all settings for the Application functions, press the [Reset] key.

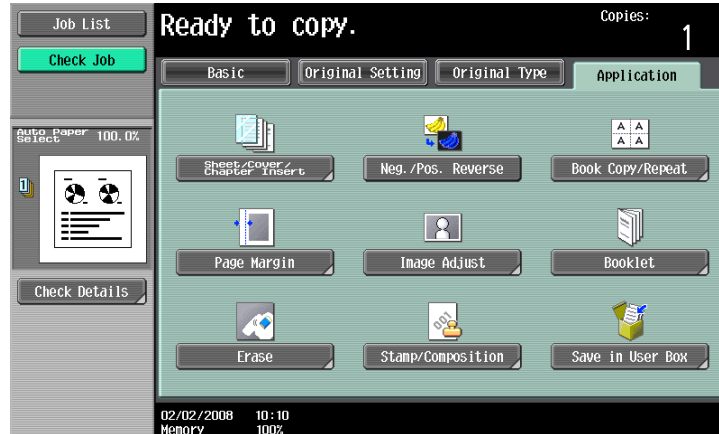

The Stamp/Composition screen appears.

- 3 Touch [Stamp Repeat].

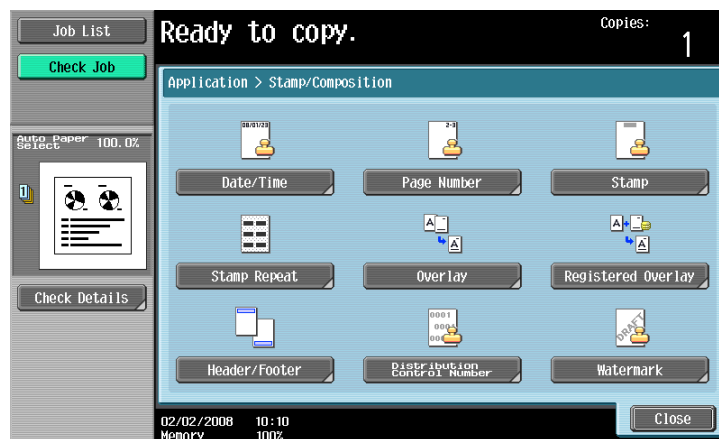

The Stamp Repeat screen appears.

- 4 Select the desired type of repeating stamp.
 - To cancel the "Stamp Repeat" function, touch [No].

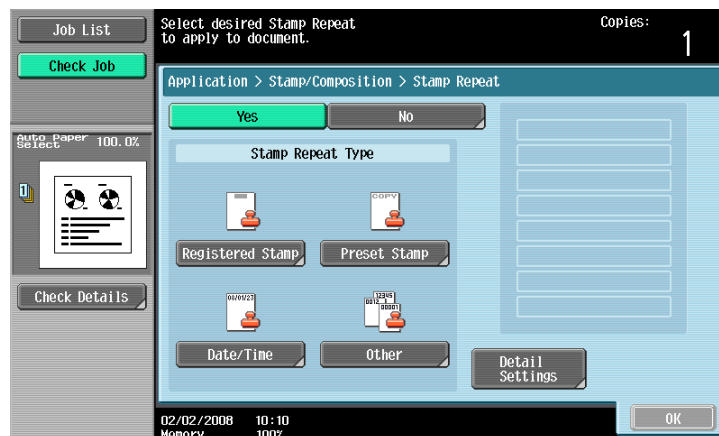

- Touch [Registered Stamp] or [Preset Stamp] to display a screen containing buttons for the available stamps. Touch the button for the desired stamp, and then touch [OK].

- Use the Copy Protection Utility to register a registered stamp. For details on registering stamps, refer to the manual of the Copy Protection Utility.
- The selected repeating stamp formats appear in a column at the center of the screen. Up to eight text lines can be combined.
- Multiple registered stamps or preset stamps cannot be selected.

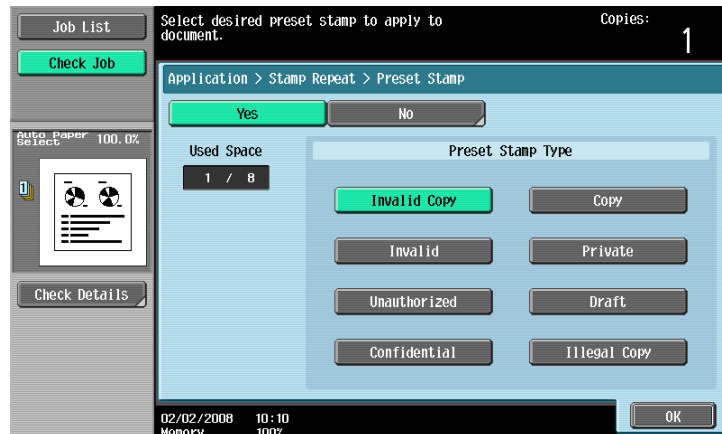

- Touching [Date/Time] displays the Stamp Repeat > Date/Time screen. Select the desired settings under "Date Type" and "Time Type", and then touch [OK].
- The repeating stamp date and time that is printed is the date and time when the original is scanned.

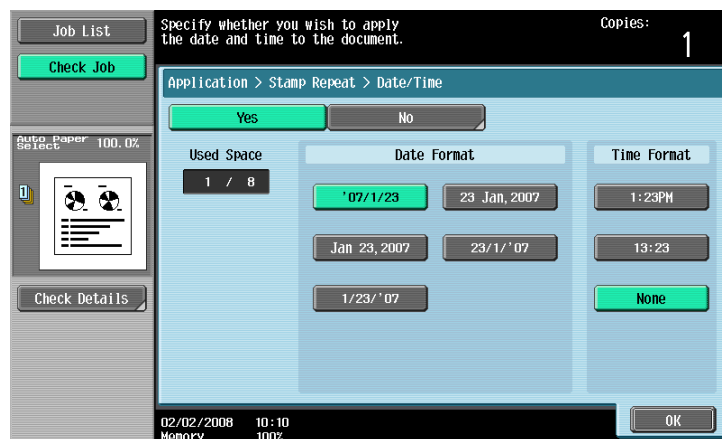

- Touching [Other] displays a screen for specifying settings for other stamps. Touch the button for the desired stamp, and then touch [OK].
- To cancel the changes to the settings in each repeating stamp settings screen, touch [No].
- To print the copy job number, touch [Yes] under "Job Number".
- To print the serial number of this machine, touch [Yes] under "Serial Number". For details on specifying settings for the serial number, contact your service representative.
- To print the copy distribution number, touch [Yes] under "Distribution Control Number". A distribution number between 1 and 99,999,999 can be specified.

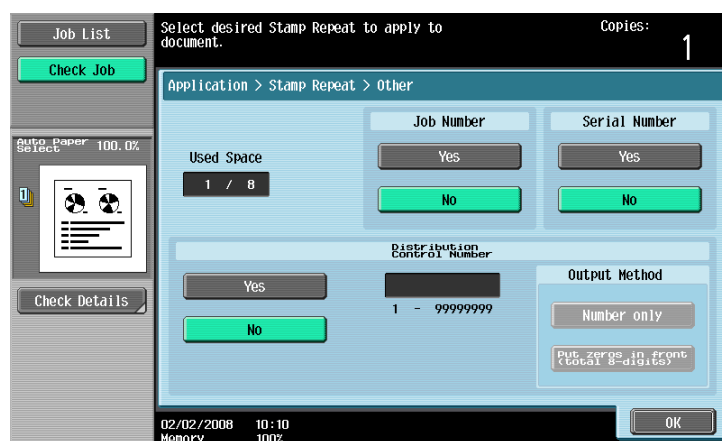

- If desired, touch [Detail Settings], and then change the repeating stamp settings. Touch the desired button in the Detail Settings screen, and then change the setting in the screen that appears.

- As the factory default, the following settings are selected. Density: Std.; Text Size: Std.

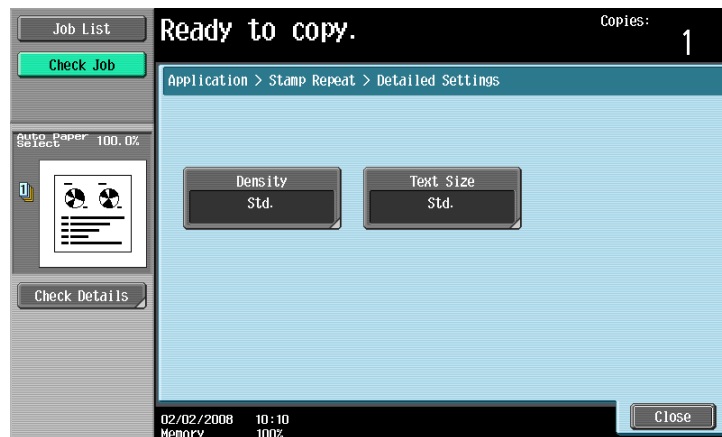

Density screen

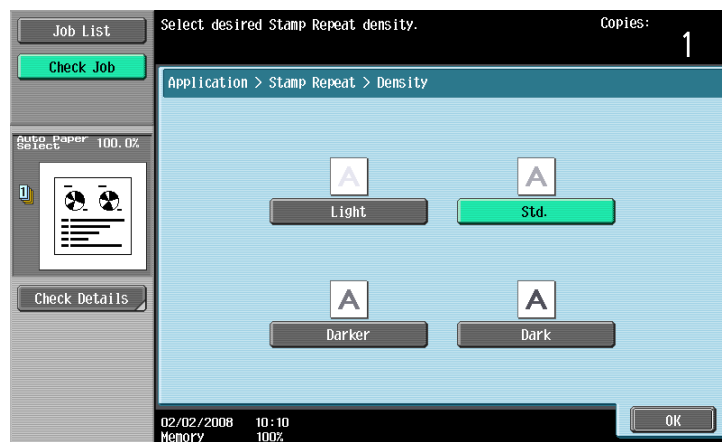

Text Size screen

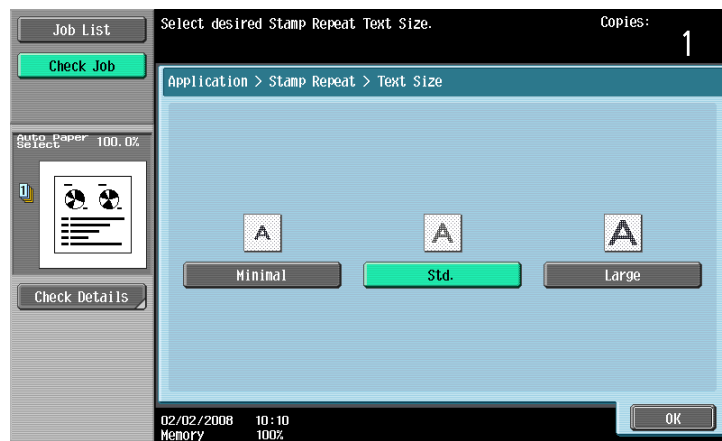

- If desired, touch [Change Pos./Delete], and then change the arrangement of the text.

- To change the arrangement order, touch [Change Position], select the repeating stamp text to be moved, and then touch either [Up] or [Down].

Change Position screen

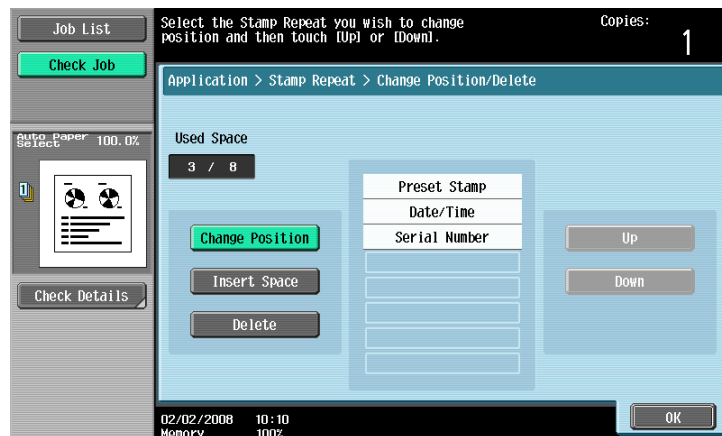

- To add a space to the repeating stamp, touch [Insert Space]. Touch either [Up] or [Down] to move the round mark that appeared beside the specified repeating stamp type, and then touch [Insert].

Insert Space screen

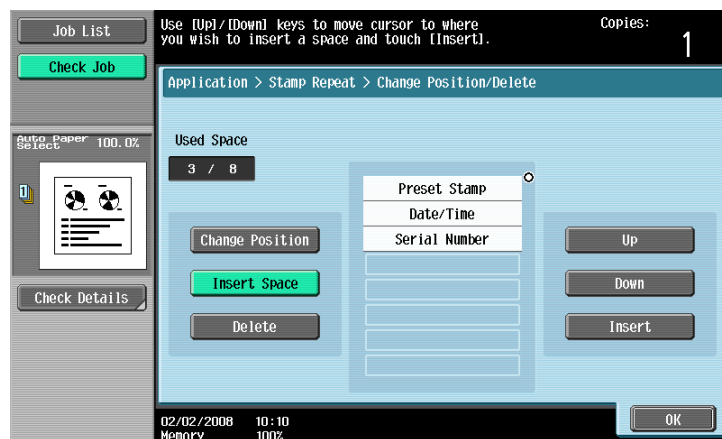

- To delete the repeating stamp text, touch [Delete], and then touch the button for the repeating stamp text to be deleted.

Delete screen

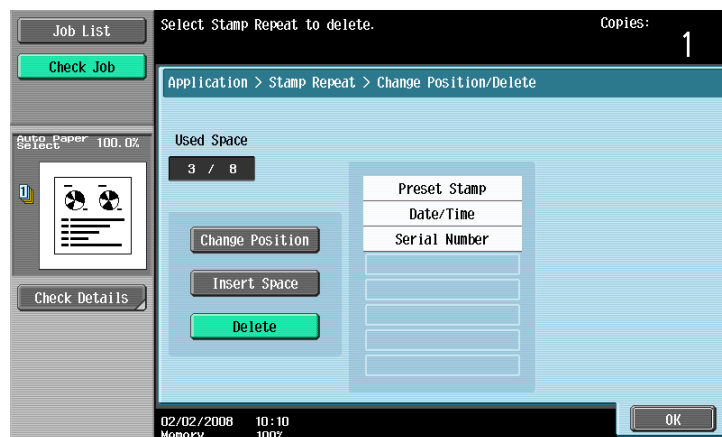

- 5 Touch [OK], and then touch [Close].
- 6 Specify any other desired copy settings.
- 7 Using the keypad, type in the desired number of copies.
- 8 Press the [Start] key.

7.15.5 Printing the image scanned first overlapped by the remaining original pages ("Overlay" function)

Copies can be printed with the contents of the first scanned original page overlapped by the remaining original pages.

In addition, a scanned original can be stored as a registered overlay and recalled and used later.

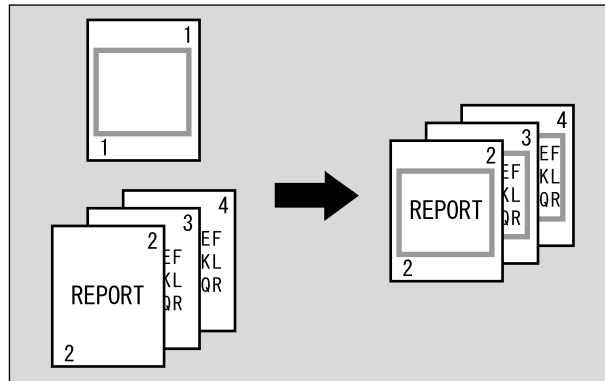

- 1 Position the original for the overlay.
- 2 Touch [Application], and then touch [Stamp/Composition].

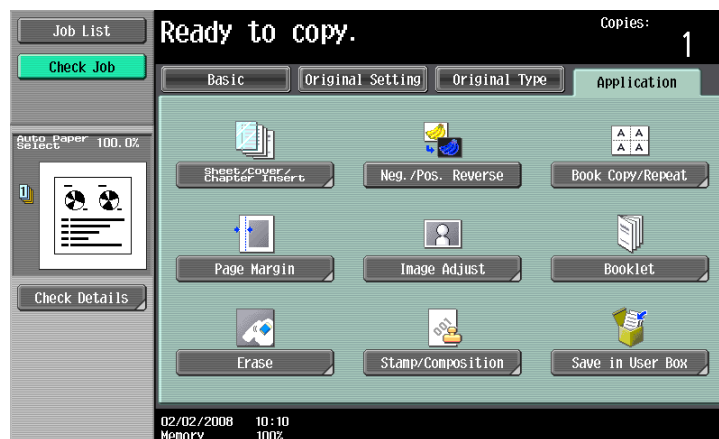

The Stamp/Composition screen appears.

- 3 Touch [Overlay].
 - To cancel the "Overlay" function, touch [No].
 The Overlay screen appears.
- 4 Select the desired settings for "Pages".

- To print the overlay image only on the first copied page, touch [1st Page Only] under "Pages".

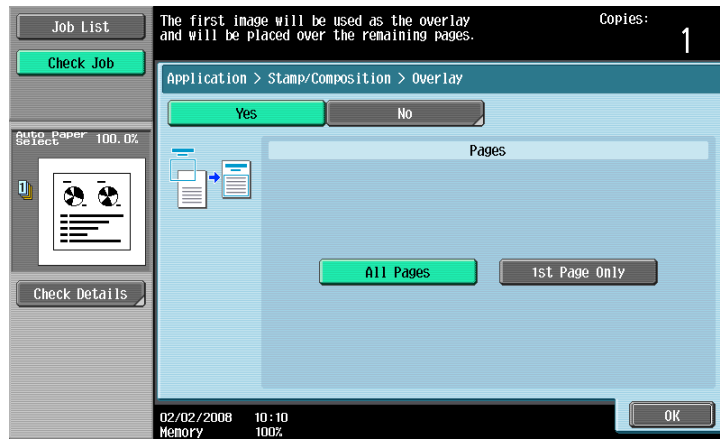

- 5 Touch [Close].
- 6 Specify any other desired copy settings.
- 7 Using the keypad, type in the desired number of copies.
- 8 Press the [Start] key.

7.15.6 Saving a scanned image as a registered overlay ("Registered Overlay" function)

- 1 Position the original to be stored as overlaying image.
- 2 Touch [Application], and then touch [Stamp/Composition].

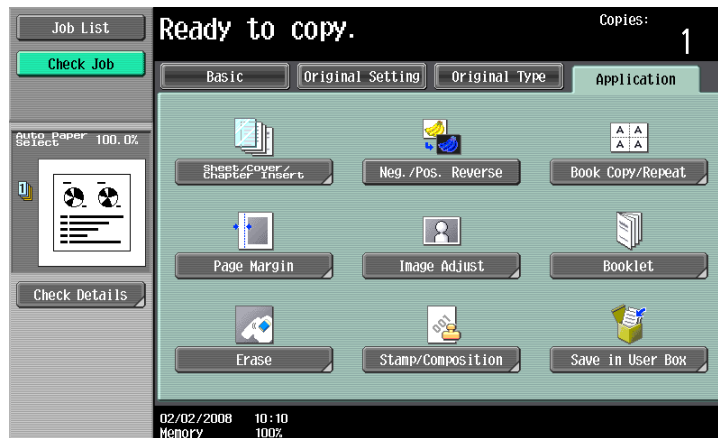

The Stamp/Composition screen appears.

- 3 Touch [Registered Overlay].

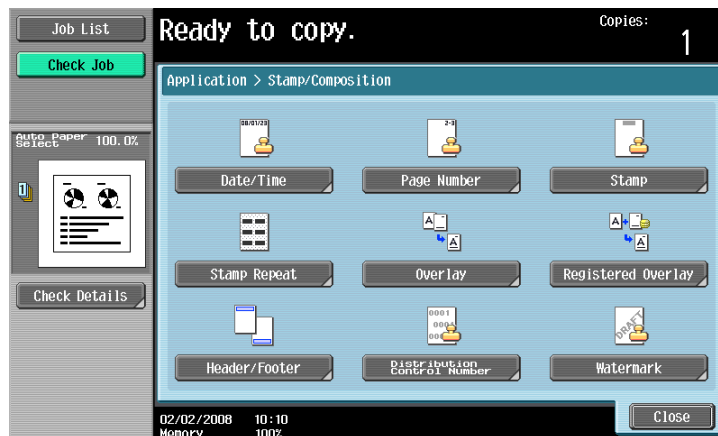

The Registered Overlay screen appears.

- 4 Touch [Register Overlay Image].
 - To cancel the Registered Overlay function, touch [No].

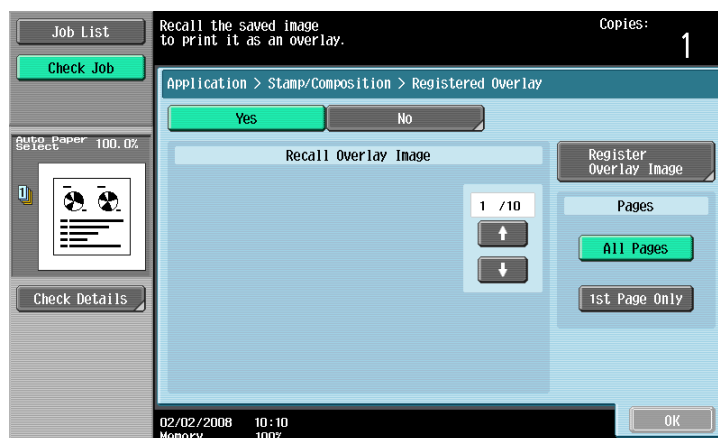

The Register Overlay Image screen appears.

5 Touch [New].

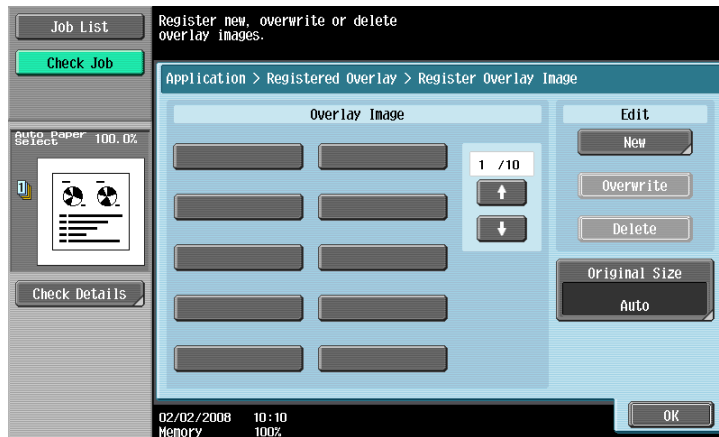

- To overwrite the registered overlay with the new image, select a registered overlay, and then touch [Overwrite].
- To delete a registered overlay, select a registered overlay, and then touch [Delete].
- After touching the button for the registered overlay, the date that the overlay was registered appears.



The Image Name Registration screen appears.

6 Type in the image name, and then touch [OK].

- Touch the buttons in the keyboard that appears in the screen to type. For details on typing in text, refer to ["Entering text" on page 14-2](#).



7 Check the original size of [Original Size], and then touch [OK].

- If the original size cannot be detected automatically or to specify the original size, touch [Original Size], and then specify the original size from any of the screens. To cancel changes to the settings, touch [Cancel].



- 8 Touch [OK], and then touch [Close].



- 9 Specify any other desired copy settings.
- 10 Press the [Start] key.
- 11 The original is scanned, then saved as a registered overlay.

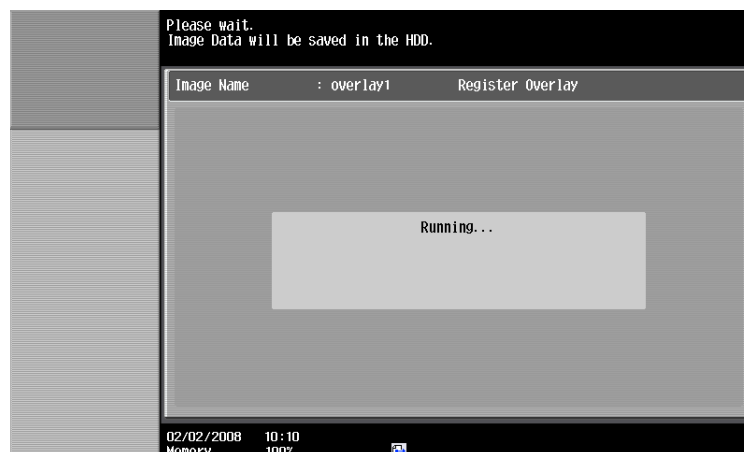

Note

With the "Restrict User Access" parameter in Administrator mode, changes to a registered overlay without administrator permission can be prevented.

7.15.7 Using a registered overlay ("Registered Overlay" function)

- 1 Position the original for overlay.
- 2 Touch [Application], and then touch [Stamp/Composition].

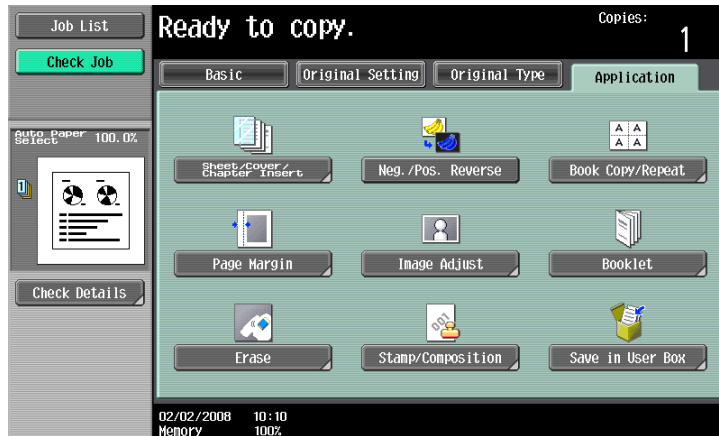

The Stamp/Composition screen appears.

- 3 Touch [Registered Overlay].

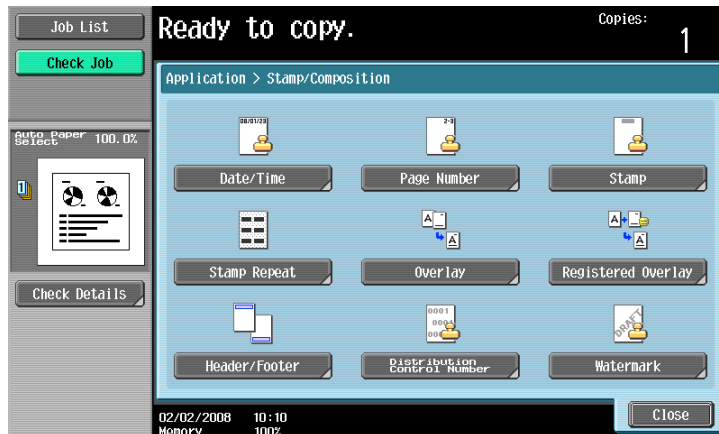

The Registered Overlay screen appears.

- 4 Touch the button for the "Registered Overlay" to be used, and then touch [OK].
 - To cancel the "Registered Overlay" function, touch [OK].
 - After touching the button for the registered overlay, the date that the overlay was registered appears.
 - To print the overlay image only on the first copied page, touch [1st Page Only] under "Pages".



- 5 Touch [OK] and then touch [Close] in the next screen that appears.
- 6 Specify any other desired copy settings.
- 7 Using the keypad, type in the desired number of copies.
- 8 Press the [Start] key.

7.15.8 Printing a header/footer ("Header/Footer" function)

- ✓ In order to use headers/footers, a header/footer must be registered in advance from Administrator mode. For details on registering headers/footers, refer to ["Specifying headers/footers" on page 11-56](#).

- 1 Position the original to be copied.
 - For details on positioning the original, refer to ["Feeding the original" on page 2-6](#).
- 2 Touch [Application], and then touch [Stamp/Composition].

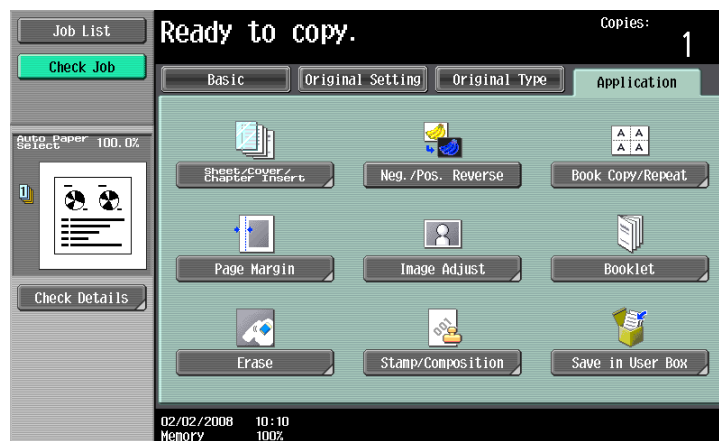

- 3 Touch [Header/Footer].
 - To cancel changes to the settings for all Application functions, press the [Reset] key. All changes to the settings are canceled.
 - If no header/footer is registered in Administrator mode, [Header/Footer] does not appear.

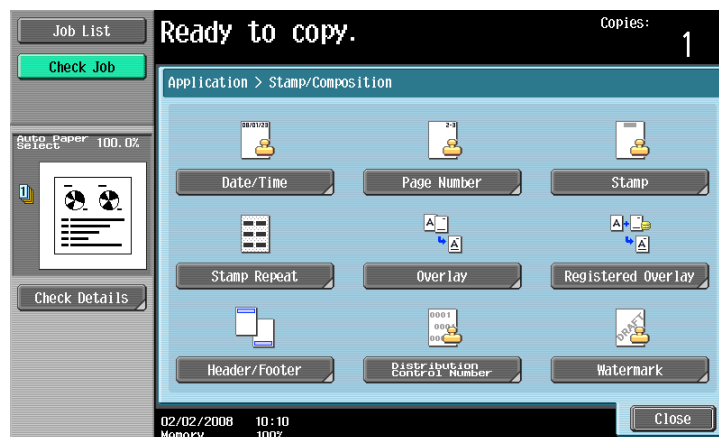

The Header/Footer screen appears.

- 4 Under "Recall Header/Footer", touch the button of the header/footer to be used, and then touch [OK].

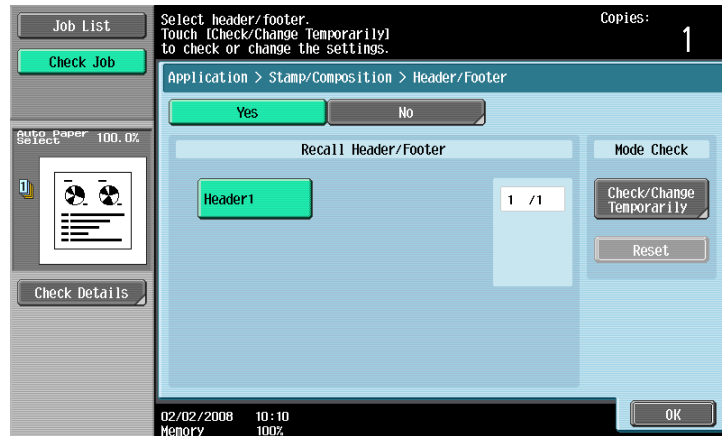

- To check or temporarily change the header/footer settings, touch [Check/Change Temporarily].

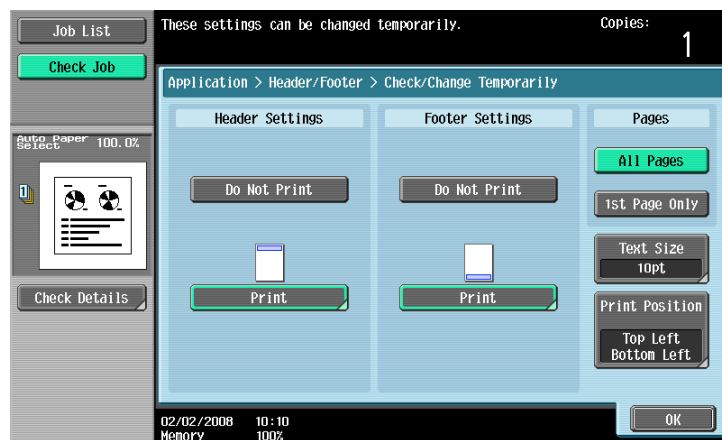

- 5 Touch [OK], and then touch [Close].
- 6 Specify any other desired copy settings.
- 7 Using the keypad, type in the desired number of copies.
- 8 Press the [Start] key.

7.15.9 Printing the distribution control number ("Distribution Control Number" function)

- 1 Position the original to be copied.
 - For details on positioning the original, refer to "Feeding the original" on page 2-6.
- 2 Touch [Application], and then touch [Stamp/Composition].
 - To cancel changes to the settings for all Application functions, press the [Reset] key. All changes to the settings are canceled.

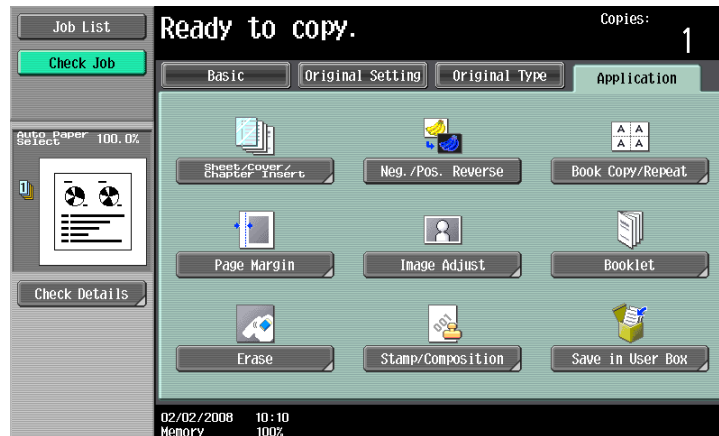

The Stamp/Composition screen appears.

- 3 Touch [Distribution Control Number].

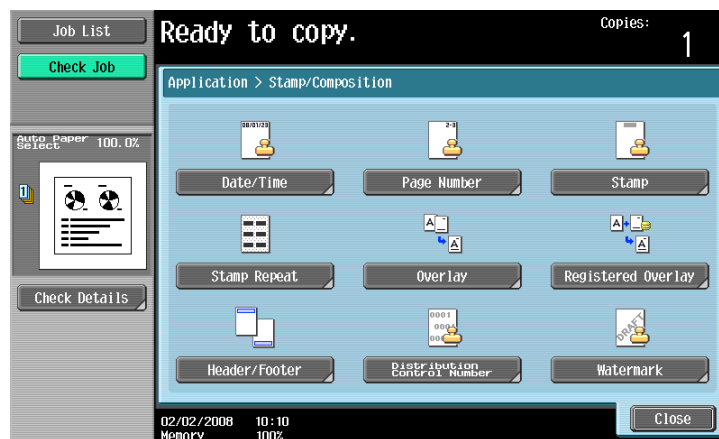

The Distribution Control Number screen appears.

- 4 Using the keypad, type in the starting distribution control number for printing.
 - To cancel the Distribution Control Number function, touch [No].

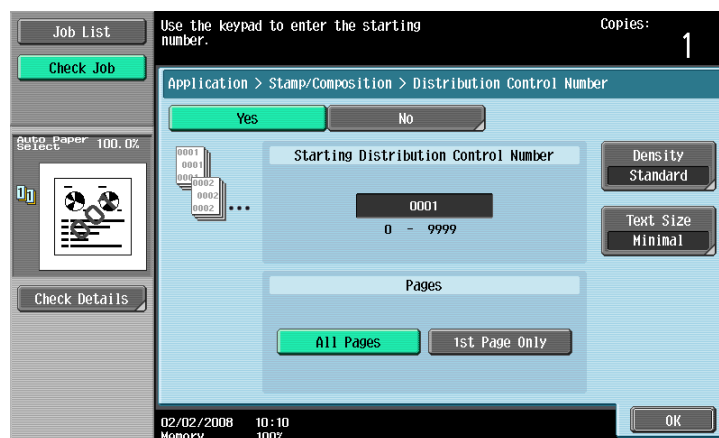

- 5 Select the desired setting under "Pages".
 - To print the distribution control number only on the first page, touch [1st Page Only].
 - The distribution control number will not be printed on blank pages inserted using "Cover Sheet", "Insert Sheet", and "Chapters" functions.
- 6 If necessary, specify the other settings.
 - As the factory default, the following settings are selected.
Density: Standard, Text Size: Standard
 - To specify the density, touch [Density], and then select the desired density.

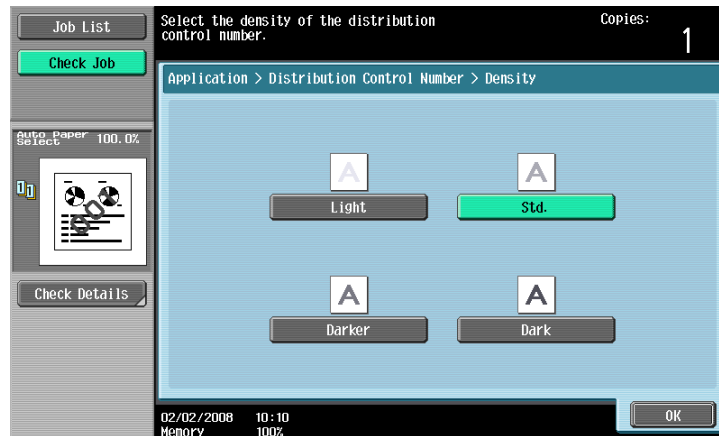

- To specify the text size, touch [Text Size], and then select the desired size.



- 7 Touch [OK], and then touch [Close].
- 8 Specify any other desired copy settings.
- 9 Using the keypad, type in the desired number of copies.
- 10 Press the [Start] key.

7.15.10 Printing the watermark onto copies ("Watermark" function)

- 1 Position the original to be copied.
 - For details on positioning the original, refer to **"Feeding the original" on page 2-6**.
- 2 Touch [Application], and then touch [Stamp/Composition].
 - To cancel changes to the settings for all Application functions, press the [Reset] key. All changes to the settings are canceled.

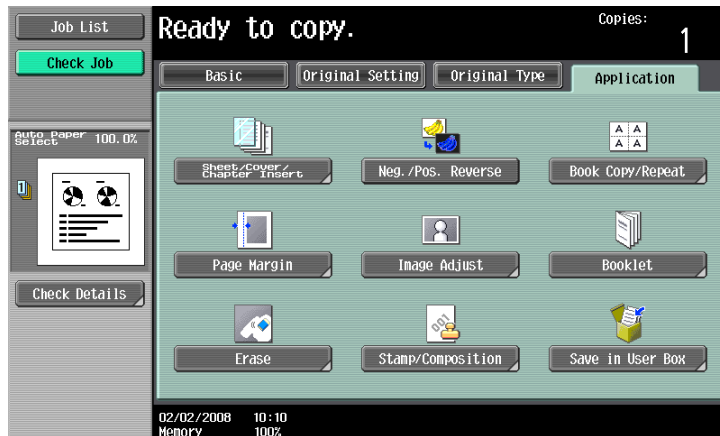

The Stamp/Composition screen appears.

- 3 Touch [Watermark].

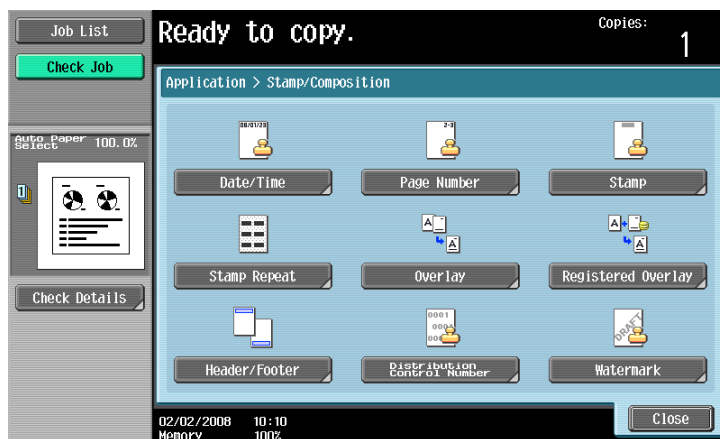

The Watermark screen appears.

- 4 Select the desired watermark.
 - To cancel the Watermark function, touch [No].

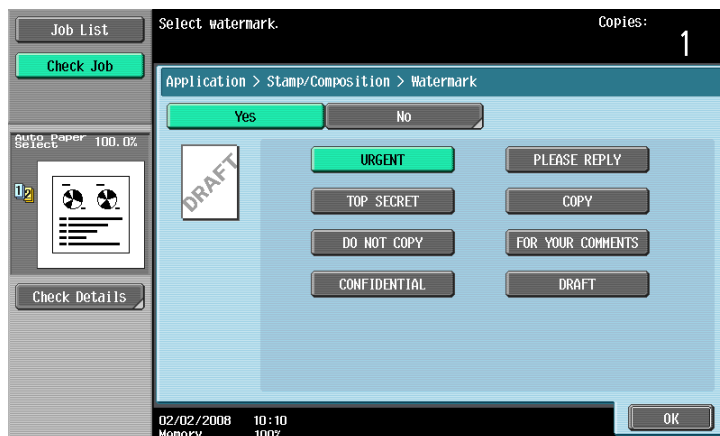

- 5 Touch [OK], and then touch [Close].
- 6 Specify any other desired copy settings.
- 7 Using the keypad, type in the desired number of copies.
- 8 Press the [Start] key.

7.16 Saving the scanned original in a user box ("Save in User Box" function)

A scanned original can be saved in a user box. Documents saved in user boxes can be printed when necessary.



Detail

For details on the user box settings, refer to the User's Guide [Box Operations].

- 1 Position the original to be copied.
- 2 Touch [Application], and then touch [Save in User Box].

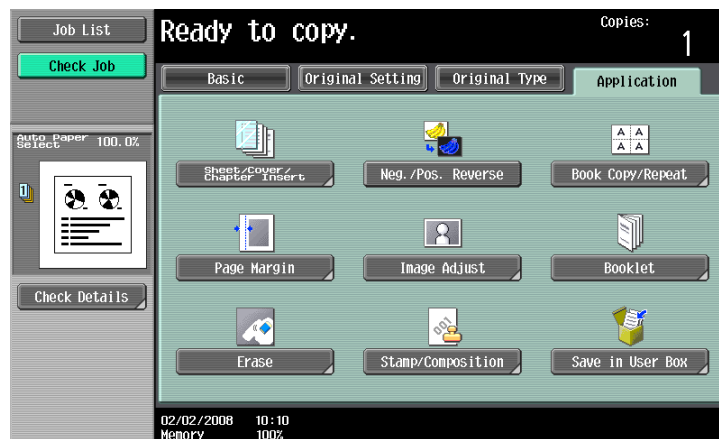

- 3 Touch [User Box].

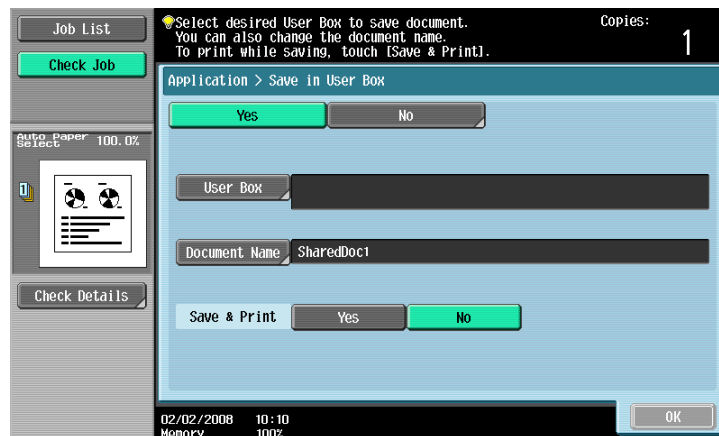

A screen for selecting a user box appears.

- 4 Select the user box where the data is to be saved.
 - Touch the tab containing the desired user box, and then button for the user box.
 - To type in a user box number to specify the user box, touch [Enter User Box No.].

- It is not necessary to enter the password when saving data, even if a password has been specified for the box.

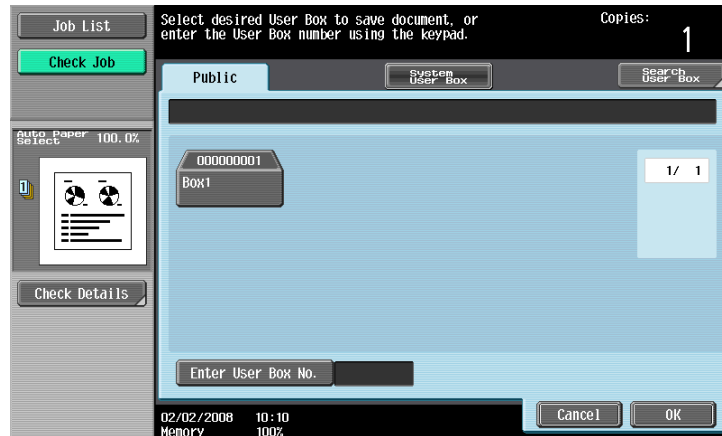

- Touching [Search User Box] displays the Search User Box screen. User boxes can be searched for by the first letter of their name. Touch [etc] or the button that includes the first letter of the user box name to display a list of user boxes starting with the selected letter. A user box can be selected from this screen.



- 5 Touch [OK].
- 6 Check the name of the document to be saved. To change the name that is automatically specified, touch [Document Name].

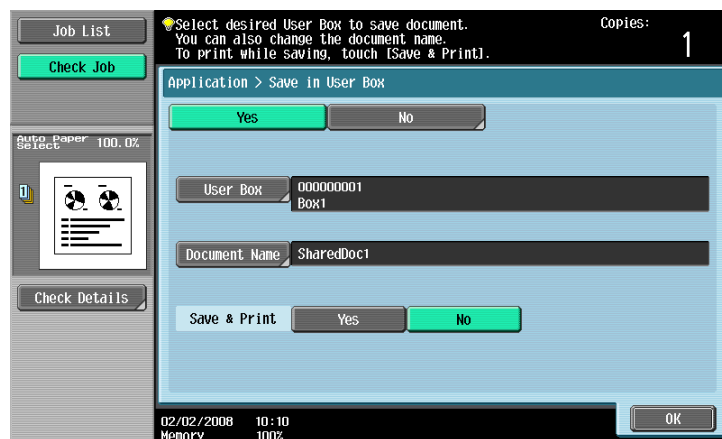

- 7 After typing in the name, touch [OK].
- For details on typing in text, refer to "Entering text" on page 14-2.



- 8 Select whether or not a copy will also be printed when the data is saved. To print a copy, touch [Yes] beside "Save & Print".

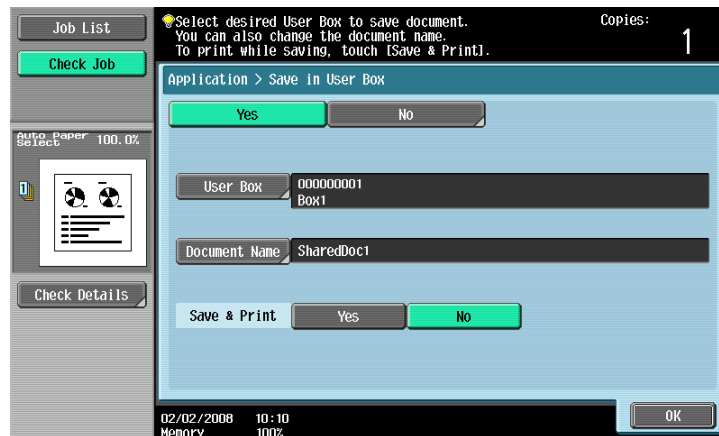

- 9 Touch [OK].
- To cancel the "Save in User Box" function, touch [No].
The Application screen appears again.
- 10 Specify any other desired copy settings.
- 11 Press the [Start] key.
- If [Yes] beside "Page Print" was selected, the scanned original is copied and the document data is saved in the specified user box.
- If [No] beside "Page Print" was selected, the data for the scanned original is saved in the specified user box.



Detail

For details on using documents saved in user boxes, refer to the User's Guide [Box Operations].



**Replacing toner cartridges
and staple cartridges and
emptying hole-punch scrap
box**

8 Replacing toner cartridges and staple cartridges and emptying hole-punch scrap box

8.1 Replacing the toner cartridge

When the toner is about to run out, an advanced warning message similar to the one shown below appears.

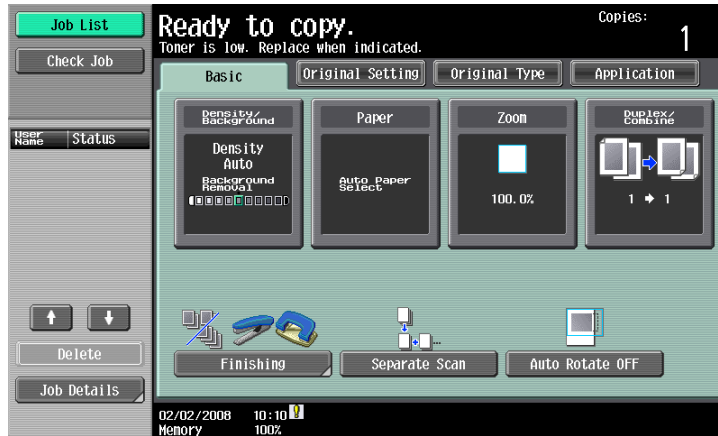

Detail

When the message appears, prepare to replace the toner cartridge according to your maintenance agreement.



Note

After the message appears, the machine stops operating. Replace the toner cartridge according to your maintenance agreement.



Detail

For details on replacing the toner cartridge, refer to ["To replace the toner cartridge" on page 8-3.](#)

Display in Enlarge Display mode

When the toner is about to run out, [!] appears on the screen. Touch [!] to display the following message.

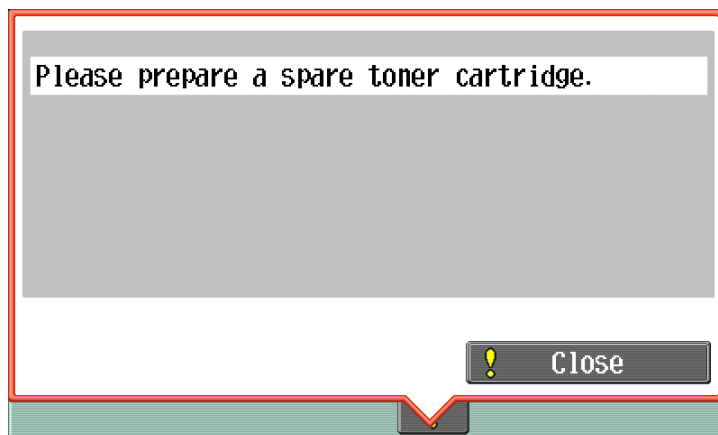

When the toner is empty, the screen shown below appears.

WARNING

Precaution for the empty toner cartridge

If it is thrown into a fire, the toner may ignite and cause a dangerous situation.

- DO NOT THROW toner or the empty toner cartridge into a fire!

CAUTION

Precaution for storing and handling the toner cartridge

If too much of toner is inhaled or toner gets in your eyes, your health may be affected.

- Keep the toner cartridge away from children.
- Be careful not to spill toner inside the machine or get toner on your clothes or hands.
- If your hands become soiled with toner, immediately wash them with soap and water.
- If toner gets in your eyes, immediately flush them with water, and then seek professional medical attention.

8.1.1 To replace the toner cartridge

- ✓ Use the same number toner cartridge as described on the label applied on the upper left side of the toner cartridge cover. Otherwise, machine trouble may occur.

- 1 Open the toner cartridge door.

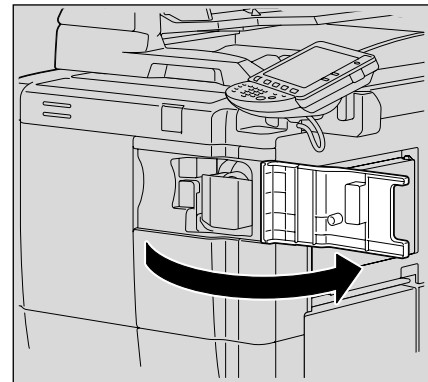

- 2 Pull out the cartridge holder.

- While pulling the toner unit lever toward you, pull the cartridge holder out toward you as far as possible.

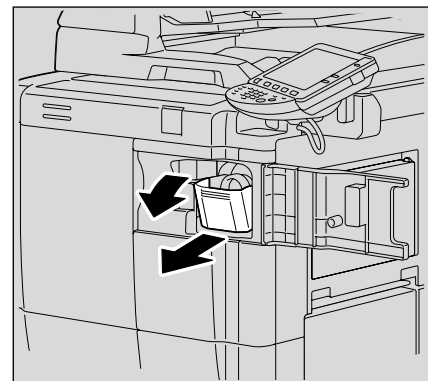

- 3 Withdraw and pull up the used toner cartridge to remove it.

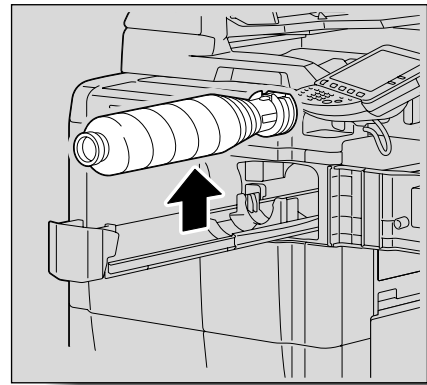

- 4 Remove the new toner cartridge from the box.
 - The toner within the toner cartridge may have become compacted. Be sure to handle steps 5 until the toner is mostly broken up before installing the cartridge.

- 5 Shake the new toner cartridge by turning it over about five times.

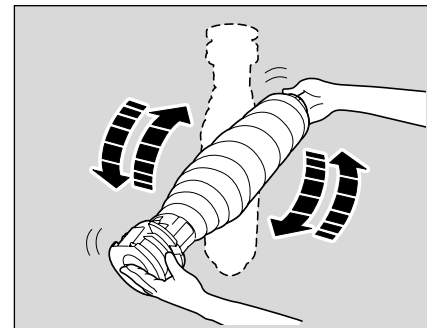

- 6 Remove the cover from the new toner cartridge.

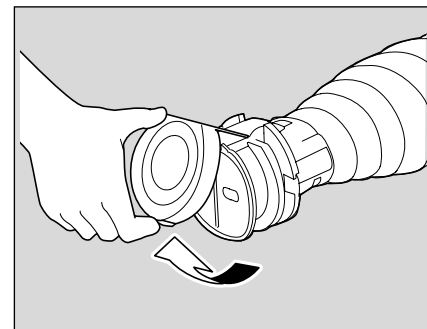

- 7 Set the toner cartridge, making sure that it is correctly oriented.
 - With the label at the end of the toner cartridge facing up, insert the bottom of the cartridge into the slot in the cartridge holder.

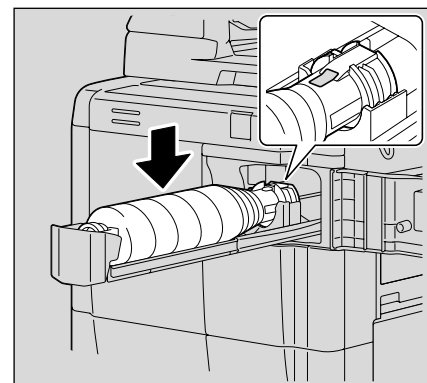

- 8 Return the cartridge holder to its original position

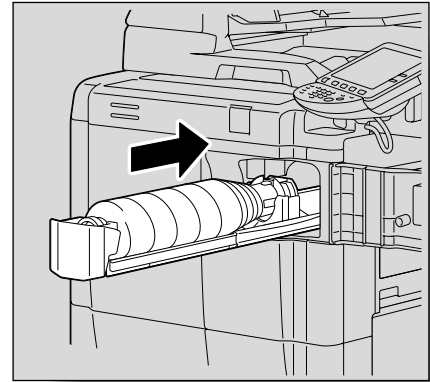

- 9 Close the toner cartridge door.

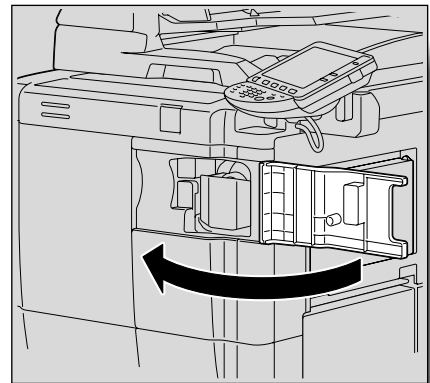

8.2 Replacing the staple cartridge

When the staple cartridge is empty, the message "Replace staple cartridge." appears. Replace the staple cartridge.

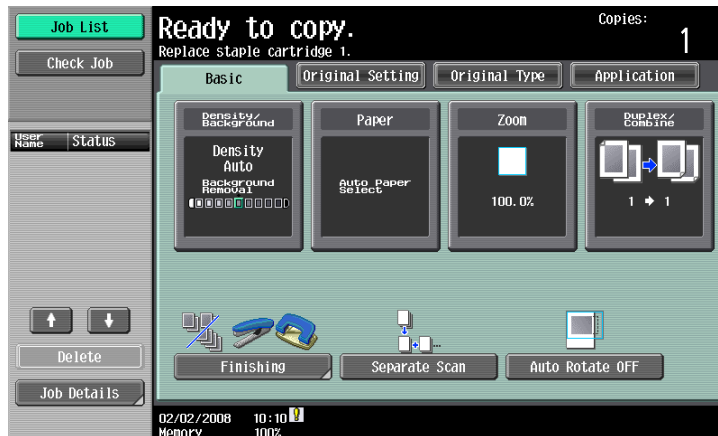

Display in Enlarge Display mode

When staples are about to run out, [!] appears on the screen.



Touch [!] to display the following message.

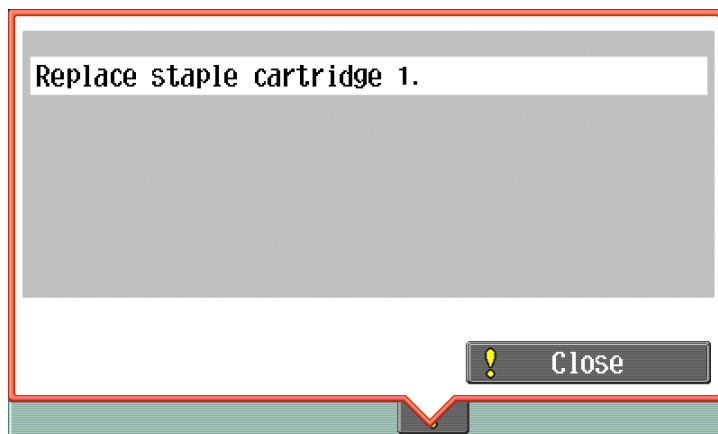

Reminder

Be sure to replace the staple cartridge only after the message appears, otherwise the machine may be damaged.

8.2.1 To replace the staple cartridge in Finisher FS-524

- 1 Open the front door.

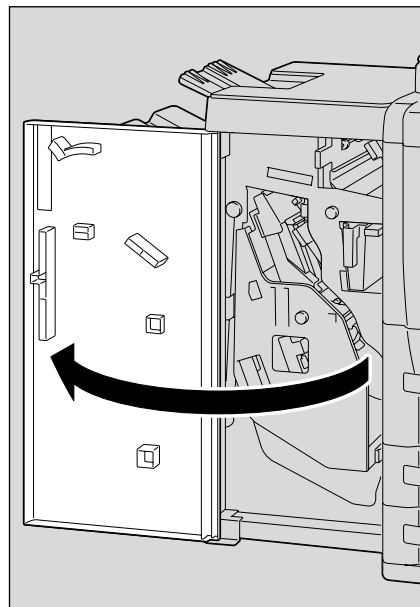

- 2 Grab handle FN7, and then pull out the stacker unit.
 - Slowly pull out the stacker unit as far as possible.

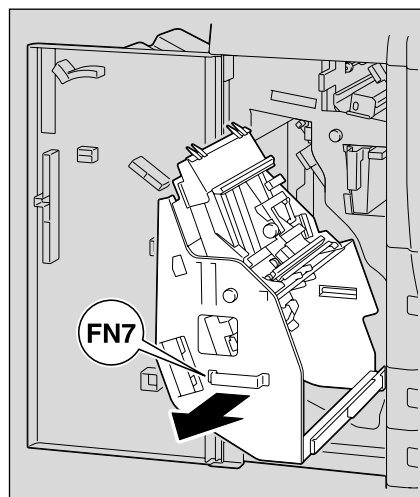

- 3** Remove the staple cartridge holder.
- Hold the lever on the staple cartridge holder, and then pull the holder down to remove it.

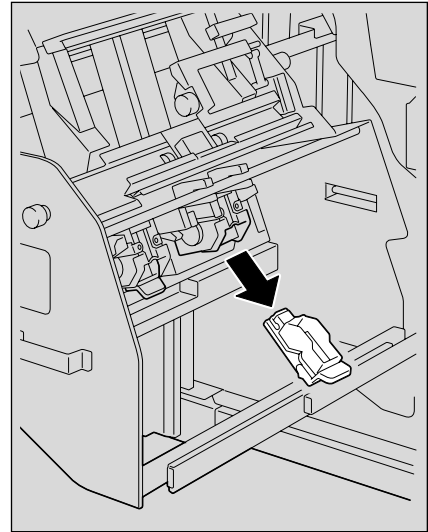

- 4** Remove the empty staple cartridge from the staple cartridge holder.

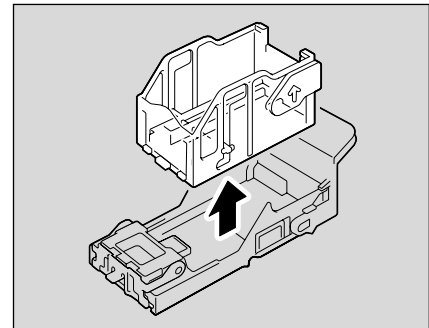

- 5** Load the new staple cartridge into the staple cartridge holder.
- Do not remove the remaining staples, otherwise the machine will not be able to staple after the cartridge is replaced.

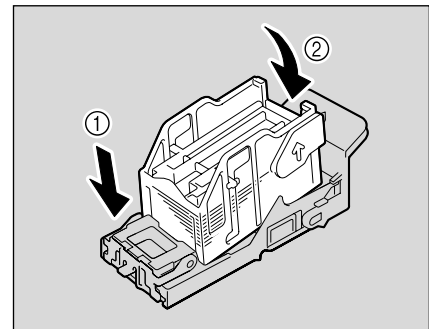

- 6** Install the staple cartridge holder.
- Check that the staple cartridge holder is securely inserted as far as possible.

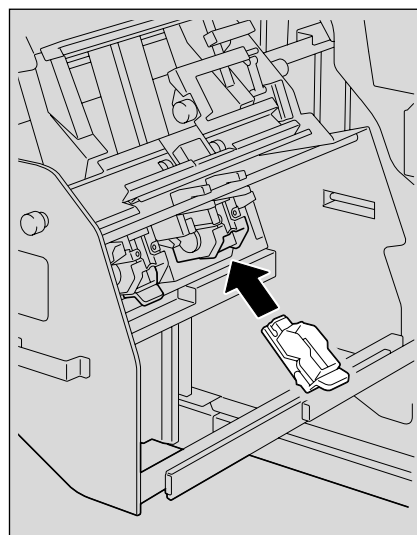

- 7** Return the stacker unit to its original position.

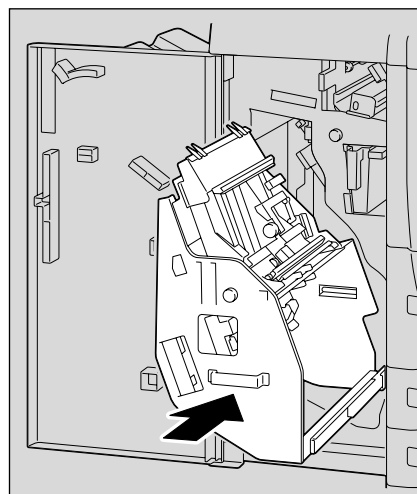

- When returning the stacker unit to its original position, do not grab any part other than handle FN7, otherwise your hand or fingers may be pinched.

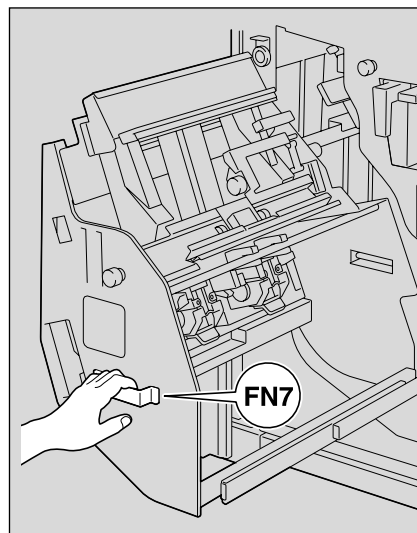

8 Close the front door.

8.2.2 To replace the staple cartridge in Finisher FS-525

- 1 Open the front door.

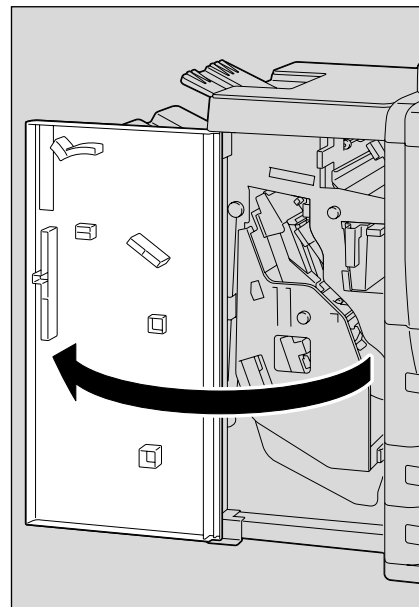

- 2 Grab handle FN7, and then pull out the stacker unit.
 - Slowly pull out the stacker unit as far as possible.

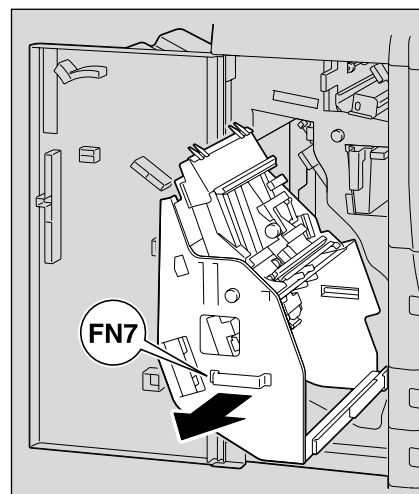

- 3** Remove the staple cartridge holder.
- Hold the lever on the staple cartridge holder to pull it up, and then pull it downward and out to remove it.

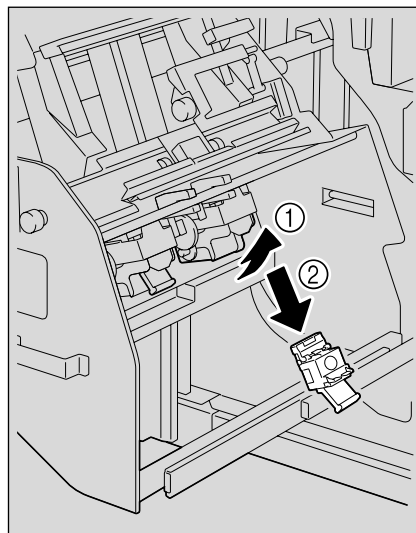

- 4** Push the portion of the staple cartridge holder indicated by "PUSH" to open the cover of the staple cartridge holder.

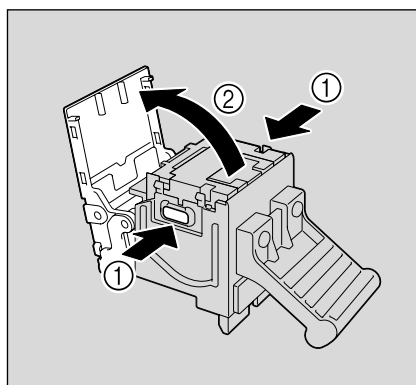

- 5** Remove the empty staple cartridge.

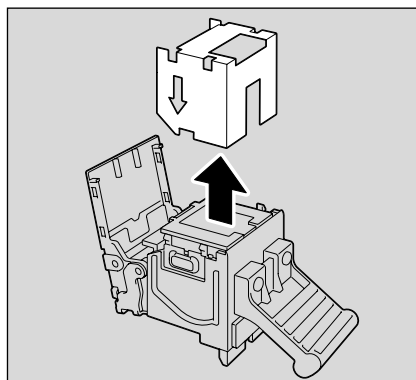

- 6** Load a new staple cartridge.

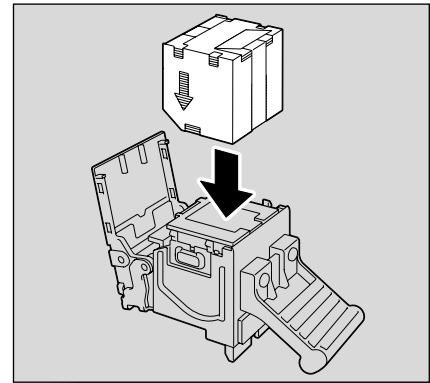

- 7** Remove the tape from the staple cartridge, and then close the cover of the staple cartridge holder.
- Do not remove the remaining staples, otherwise the machine will not be able to staple after the cartridge is replaced.

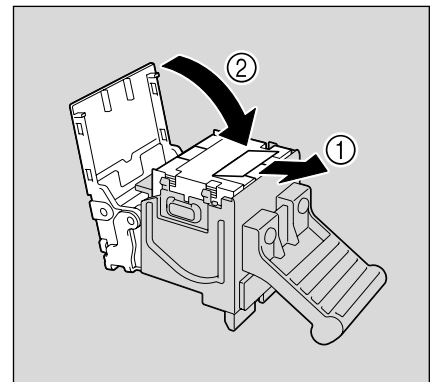

- 8** Install the staple cartridge holder.
- Check that the staple cartridge holder is securely inserted as far as possible.

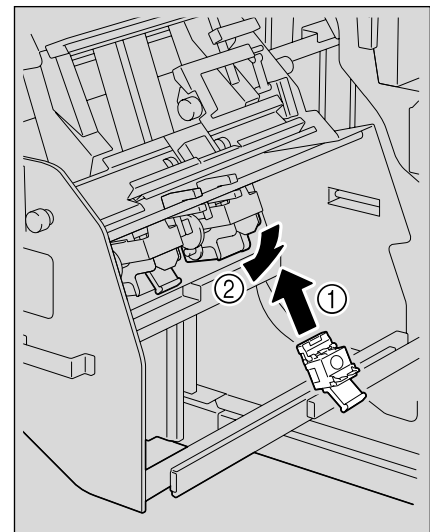

- 9 Return the stacker unit to its original position.

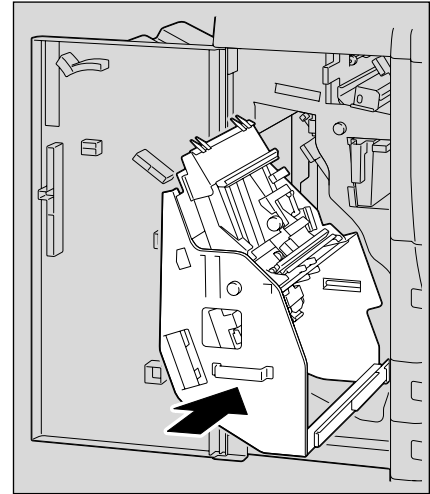

- When returning the stacker unit to its original position, do not grab any part other than handle FN7, otherwise your hand or fingers may be pinched.

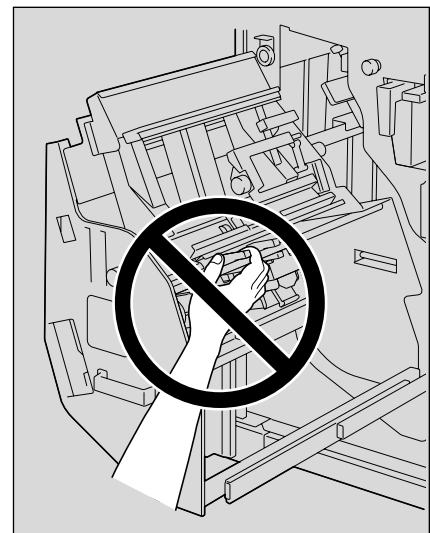
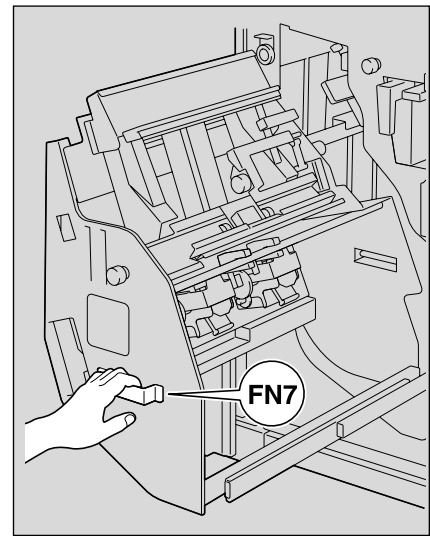

- 10 Close the front door.

8.2.3 To replace the staple cartridge in Finisher FS-610

- 1 Open the front door.

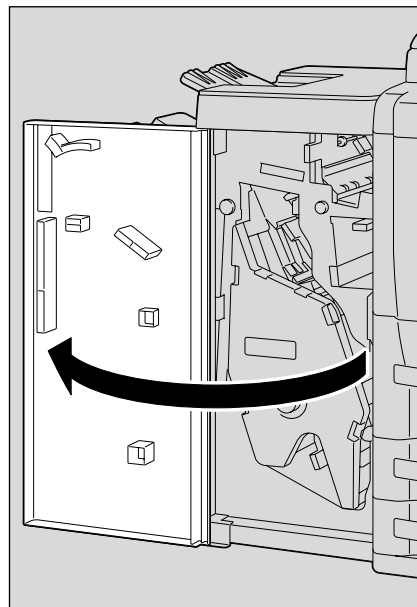

- 2 Grab handle FN6, and then pull out the stacker unit.
 - Slowly pull out the stacker unit as far as possible.

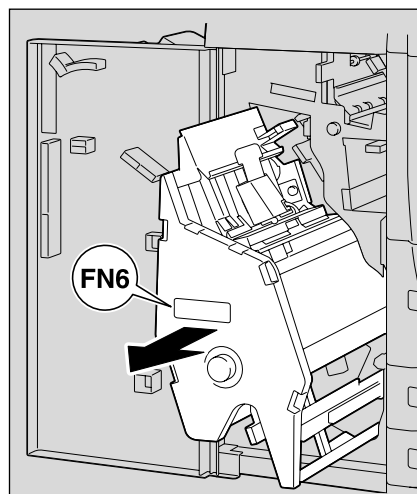

- 3 Remove the staple cartridge holder.
 - Hold the lever on the staple cartridge holder, and then pull the holder up to remove it.

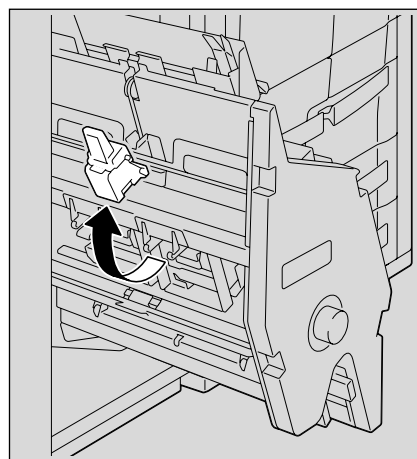

- 4 Remove the empty staple cartridge from the staple cartridge holder.

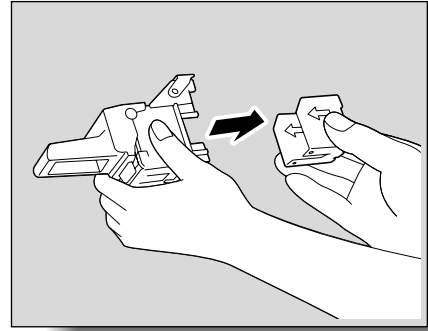

- 5 Load the new staple cartridge into the staple cartridge holder.
- Do not remove the remaining staples, otherwise the machine will not be able to staple after the cartridge is replaced.

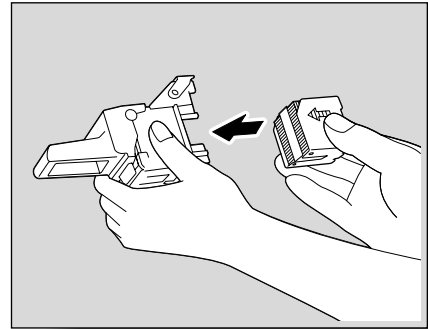

- 6 Slowly peel off the stopper tape.

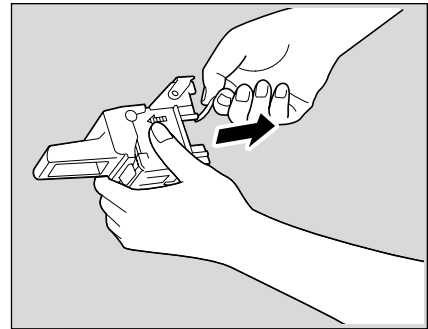

- 7 Install the staple cartridge holder.
- Check that the staple cartridge holder is securely inserted as far as possible.

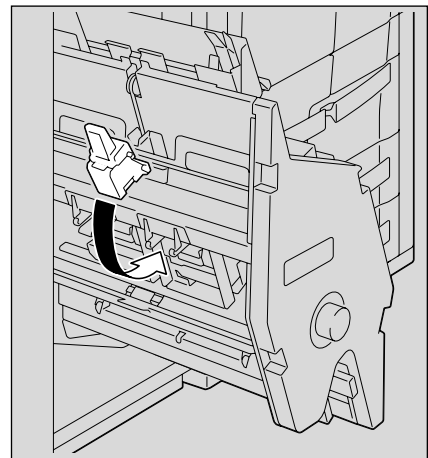

8 Return the stacker unit to its original position.

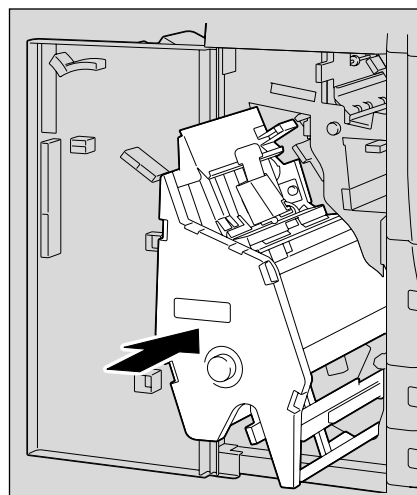

- When returning the stacker unit to its original position, do not grab any part other than handle FN6, otherwise your hand or fingers may be pinched.

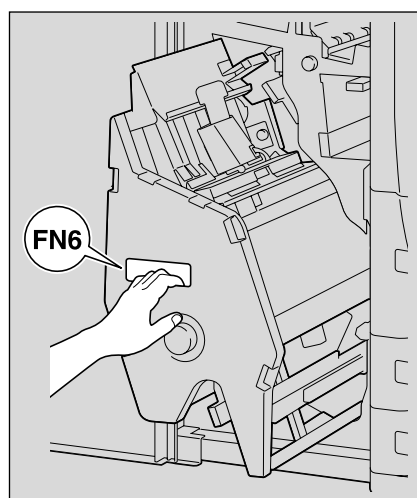

9 Close the front door.

8.3 Emptying hole-punch scrap boxes

If the hole-punch scrap box of the punch kit installed with the finisher becomes full, the message shown below appears (if the box can be emptied by the user).



Note

The setting for emptying the hole-punch scrap box should be specified by the service representative. For details, contact the service representative.

The default setting is "Service". If a message appears, immediately contact the service representative.

<Screen when a Punch setting is selected>

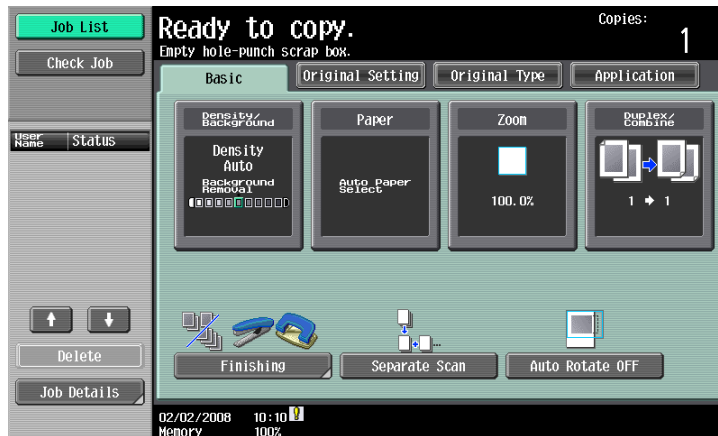

<Screen while a job is being performed>



<Display in Enlarge Display mode>

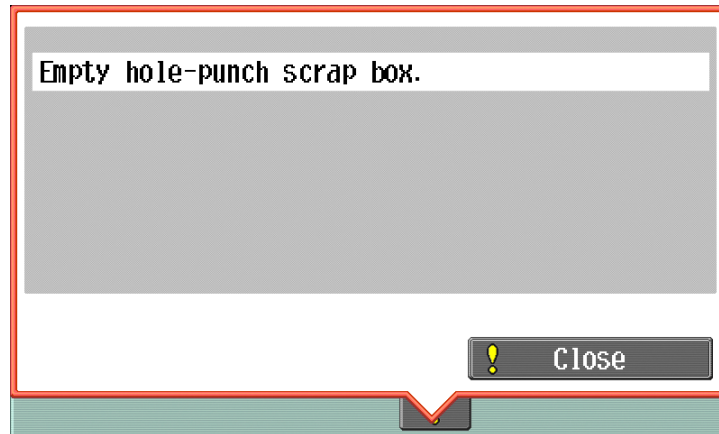

Detail

When performed by user

If the hole-punch scrap box has become full while a job is being performed, the job being performed is paused. To continue the job without canceling the Punch setting, empty the hole-punch scrap box. To cancel the Punch setting and continue the job, touch [Cancel Punching].

When performed by service representative

If the hole-punch scrap box has become full while a job is being performed, the job being performed is paused. To continue the job, touch [Cancel Punching]. However, the continued job is printed without holes being punched.

8.3.1 To empty the hole-punch scrap box of the finisher

Follow the procedure described below to empty the hole-punch scrap box.

- 1 Open the front door.

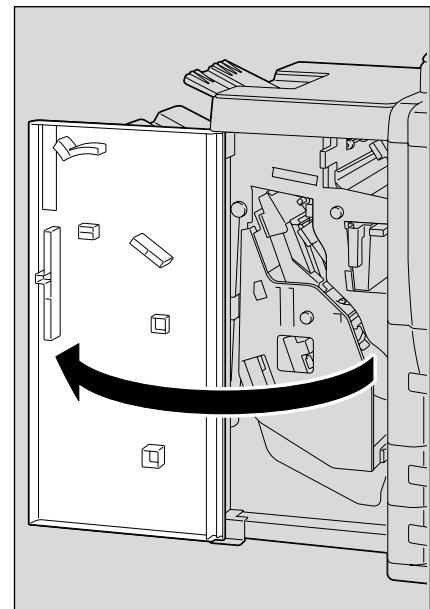

- 2 Pull out the hole-punch scrap box.



- 3 Empty the hole-punch scrap box.

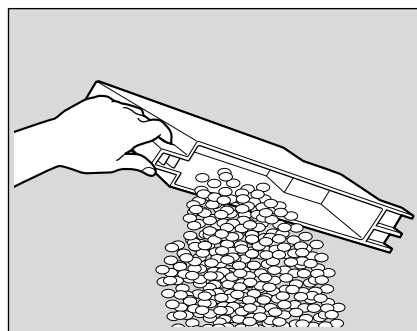

- 4 Insert the hole-punch scrap box into its original position.

- 5 Close the front door.

8.3.2 To empty the hole-punch scrap box of the Z folding unit

Follow the procedure described below to empty the hole-punch scrap box.

- 1 Open the front door.

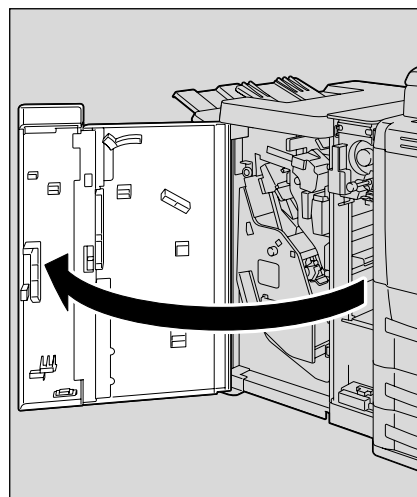

- 2 Pull out the hole-punch scrap box.

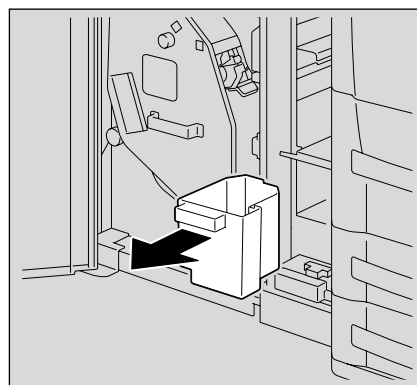

- 3 Empty the hole-punch scrap box.

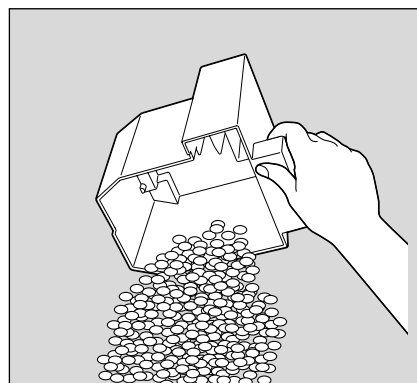

- 4 Insert the hole-punch scrap box into its original position.
- 5 Close the front door.



Care of the machine

9 Care of the machine

9.1 Cleaning

This section describes the procedures for cleaning each part.

Be sure to turn off the main power switch before cleaning it.

9.1.1 Cleaning the left partition glass

Keep the glass clean; otherwise soil marks may be copied, resulting in dark lines on the copies.

Raise the ADF, and clean the left partition glass by wiping it with a soft, dry cloth.



Reminder

Never use solvents, such as benzene or thinner, to clean the left partition glass.

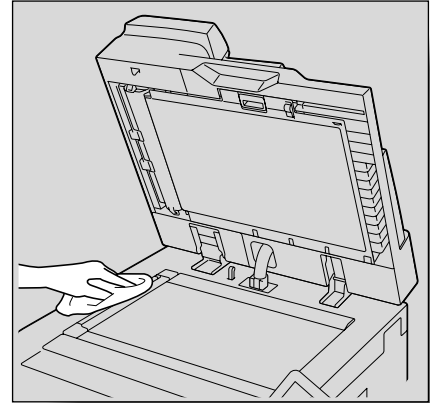

9.1.2 Cleaning the original glass

Keep the glass clean; otherwise spots may be copied.

Raise the ADF, and clean the surface of the original glass by wiping it with a soft, dry cloth.



Reminder

Never use solvents, such as benzene or thinner, to clean the original glass.

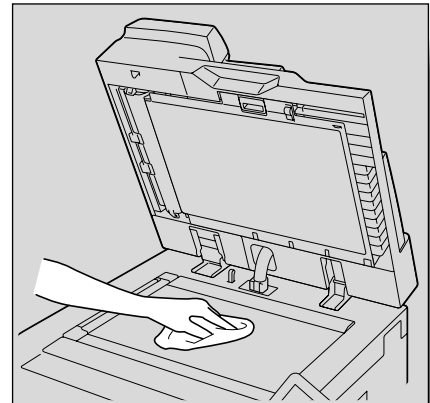

9.1.3 Cleaning the document pad

Keep the pad clean; otherwise spots may be copied.

Raise the ADF, and clean the document pad by wiping it with a soft, dry cloth.



Reminder

Never use solvents, such as benzene or thinner, to clean the document pad.

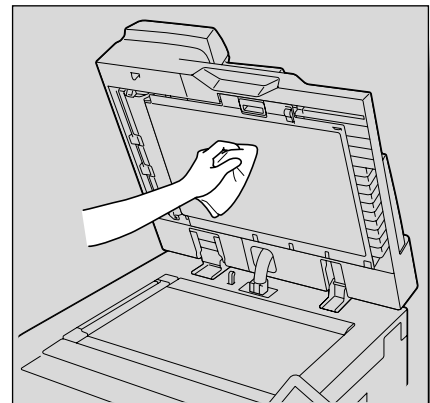

9.1.4 Cleaning the paper take-up roller

Keep the roller clean; otherwise soil marks may be copied, resulting in dark lines on the copies.

Clean the paper take-up rollers by wiping them with a soft, dry cloth.

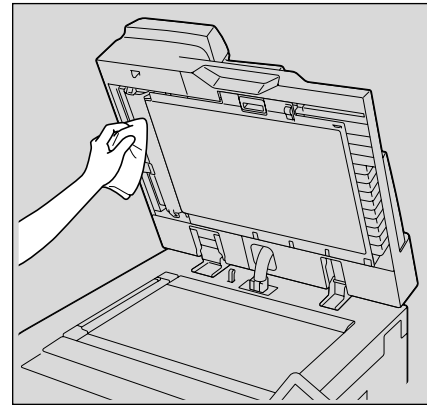

Reminder

Never use solvents, such as benzene or thinner, to clean the paper take-up roller.

9.1.5 Cleaning the main unit

Clean the surface of the main unit by wiping it with a soft cloth dampened with a mild household detergent.

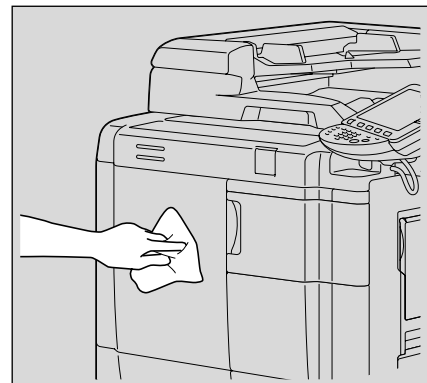

Reminder

Never use solvents, such as benzene or thinner, to clean the main unit.

9.1.6 Cleaning the control panel

Clean the control panel by wiping it with a soft, dry cloth.

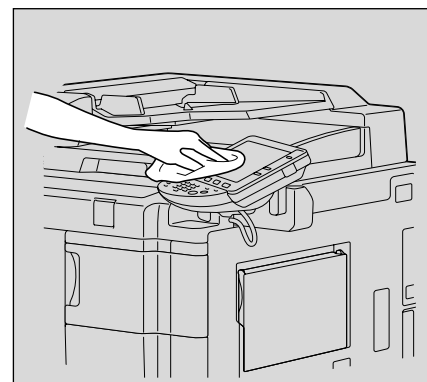

Reminder

Pressing too hard on the control panel or the touch panel may damage them. Never use a mild household detergent, glass cleaner, benzin or thinner to clean the control panel or touch panel.

9.1.7 Care of Authentication Unit (Biometric Type) AU-101



Reminder

Before cleaning the authentication unit, disconnect it from the machine. If a force is applied to the USB port, it may be damaged.

When cleaning the authentication unit, do not allow water to enter the authentication unit, otherwise the system may be damaged.

Never use organic solvents, such as benzene or alcohol, to clean the authentication unit, otherwise it may be damaged.



Note

When disconnecting or connecting the authentication unit, turn off the machine with the main power switch, and then wait at least 10 seconds before turning it on again. The machine may not operate correctly if it is turned on immediately after being turned off.

Hold the plug when plugging and unplugging the USB cable, otherwise the cable may be damaged.

Care of the housing

Frequency: Once a month, or when it is dirty

Wipe the housing with a soft, dry cloth. If the housing cannot be cleaned by wiping it, wash it with a cloth dampened with a mild detergent and wrung out well. After the housing is cleaned, rinse the cloth and wring it out well before wiping off the detergent.

Care of the scanner

Frequency: Once a month, or when it is dirty or covered with fingerprints

Care of the scanner Frequency: Once a month, or when it is dirty or covered with fingerprints Clean the scanner with a soft cloth used to wipe eyeglass lenses. If it is extremely dirty, clean it with an eyeglass lens cleaner.

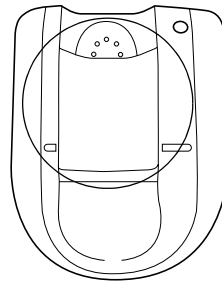

9.1.8 Care of Authentication Unit (IC Card Type) AU-201



Reminder

Before cleaning the authentication unit, disconnect it from the machine. If a force is applied to the USB port, it may be damaged.

When cleaning the authentication unit, do not allow water to enter the authentication unit, otherwise the system may be damaged.

Never use organic solvents, such as benzene or alcohol, to clean the authentication unit, otherwise it may be damaged.



Note

When disconnecting or connecting the authentication unit, turn off the machine with the main power switch, and then wait at least 10 seconds before turning it on again. The machine may not operate correctly if it is turned on immediately after being turned off.

Hold the plug when plugging and unplugging the USB cable, otherwise the cable may be damaged.

Frequency: Once a month, or when it is dirty

Wipe the authentication unit with a soft, dry cloth. If the authentication unit cannot be cleaned by wiping it, wash it with a cloth dampened with a mild detergent and wrung out well. After the authentication unit is cleaned, rinse the cloth and wring it out well before wiping off the detergent.

9.2 Viewing counters (Meter Count)

9.2.1 Viewing counters

The Meter Count screen can be displayed so that the total number of prints since counting started can be viewed.

In addition, the list of counters can be printed.

- 1 Press the [Utility/Counter] key.
- 2 Touch [Meter Count], and then touch [Check Details] in the left panel.



The Meter Count screen appears.

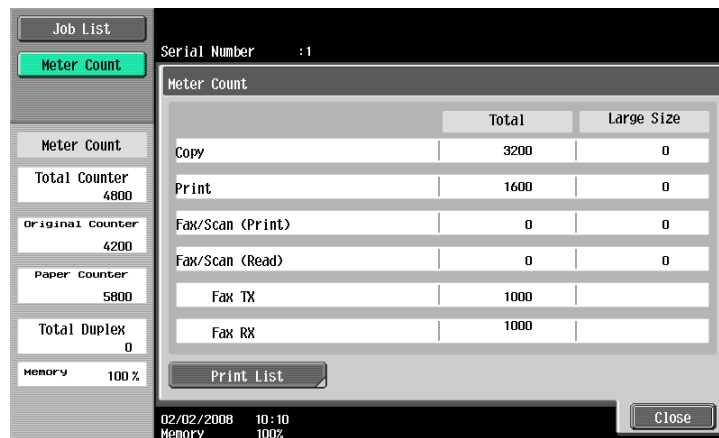

? Can the list of counters be printed?

→ Touch [Print List], select the paper size, and then press the [Start] key.

- 3 Touch [Close], and then touch [Close] in the next screen that appears.

The Basic screen appears again.



Note

The list of counters can be displayed even while the machine is copying or printing.

9.3 When the message "It is time for the scheduled inspection of the device." appears

A periodic maintenance will be required after 250,000 copies for bizhub 751/601.

If the message "It is time for the scheduled inspection of the device." appears, contact your service representative and request a periodic maintenance inspection.

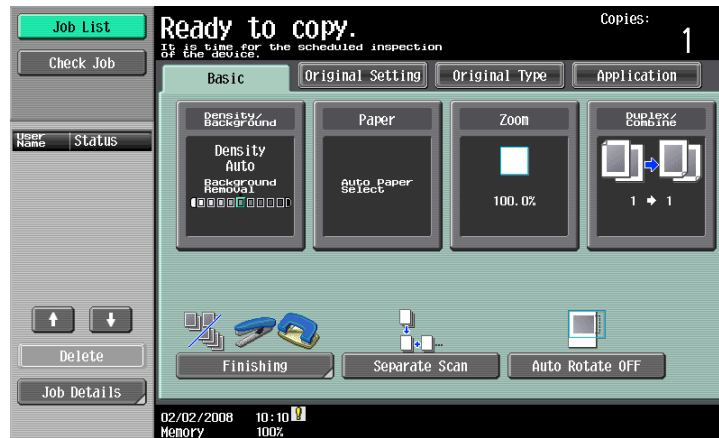

10

Managing jobs

10 Managing jobs

10.1 Overview of Job List screen

10.1.1 Jobs

Specifying the desired copy settings, then pressing the [Start] key queues the copy operation in this machine. This queued operation is called a job. In the same way, operations for making scans and computer printouts are also queued as jobs.

- Jobs that are being performed and the job log can be checked from the Job List screens.
- Jobs are printed starting with the one at the top of the Current Jobs list.
- Jobs are numbered in the order that they were programmed and are queued to be performed (printed).



Note

The job number identifies the job; it does not indicate the printing order. In addition, the job number does not change until the job is deleted.

By using the "Increase Priority" function, the selected job can be moved to the front of the queue so that it is printed first.

10.1.2 Multi-job feature

While one job is being printed, another job can be queued. A total of 250 jobs can be queued.

The number of jobs possible for each operation is listed below.

Operation	Number of jobs
Copy	5
Interrupted copy	1
Scan	5
Print	10
Fax (Quick Memory TX)	1
Fax (Memory TX)	50
Fax (Timer TX)	20
Fax RX	100
Fax (Polling RX)	1
Fax (Polling TX)	1
Sharing	56
Total	250

*The values listed above are for reference and may differ from the actual values depending on other settings.

When one job is finished being printed, the next queued job automatically begins.



Note

Up to 250 jobs, including print jobs, scanner transmission jobs, fax transmission jobs and received fax/save jobs, can be queued.

10.1.3 Job List screens

From the Job List screen, lists of jobs being performed by this machine and the jobs that have been performed in addition to the job details can be viewed, and the job settings can be changed.



Detail

To display the Job List screen, touch [Job List] in the left panel, and then touch [Job Details].

From the Job List screen, the following tabs for the various functions can be displayed.

- Print
Lists print jobs for copying, computer printing, and received faxes.
- Send
Lists fax and scanner transmission jobs.
- Receive
Lists fax transmission jobs.
- Save
Lists jobs for saving documents in user boxes.



Note

As the factory default, the Current Jobs list on the Print tab is displayed in the Job List screen.

The screen for each function listed above can be displayed from any other Job List screen. However, if a different tab is selected while a setting is being changed, that setting is canceled.

A Current Jobs list and a Job History list can be displayed for each function.

- Current Jobs:
Lists jobs that are queued and being performed, allowing you to check the current status of the machine.
- Job History:
Lists jobs that have been completed, including jobs that were not performed due to an error, allowing you to check the history and result of all jobs.

The type of jobs to be displayed can be selected from the Current Jobs list and Job History list. For example, the lists of stored jobs and active jobs can be displayed in the Current Jobs list on the Print tab, and the lists of deleted jobs, completed jobs and all jobs can be displayed in the Job History list. The types of jobs that can be selected differ depending on the selected tab.

The function of each button in the Job List screens is described below.

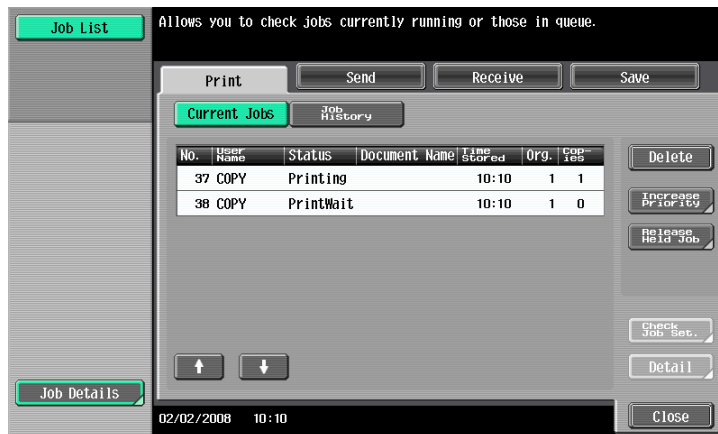

Button name	Description
[Print] button	Touch to display the Print tab of the Job List screen.
[Send] button	Touch to display the Send tab of the Job List screen. For details, refer to the User's Guide [Network Scan/Fax/Network Fax Operations].

Button name		Description
[Receive] button		Touch to display the Receive tab of the Job List screen. For details, refer to the User's Guide [Network Scan/Fax/Network Fax Operations].
[Store] button		Touch to display the Store tab of the Job List screen. For details, refer to the User's Guide [Box Operations].
[Current Jobs] button	A selected button indicates which job list is currently displayed.	Touch to switch from the Job History list to the Current Jobs list. This lists the jobs that are currently being performed and the jobs that are queued (waiting) to be performed.
[Job History] button		Touch to switch from the Current Jobs list to the Job History list. This list the jobs that have been performed.
[Delete] button ^{*1}		A job can be deleted from the Current Jobs list. For details, refer to "Deleting a job" on page 10-6.
[Increase Priority] button (displayed on the Current Jobs list of the Print tab)		The next job to be printed after the current job is finished can be changed. For details, refer to "Increasing printing priority" on page 10-14. The buttons that appear differ depending on the tab or list (Current Jobs or Job History) that is displayed.
[Release Held Job] button (displayed on the Current Jobs list of the Print tab)		Touch to display the list of stored jobs. The settings of a stored job can be changed, or the job can be printed or deleted.
[Check Job Set.] button ^{*1}		The settings for a job in the Current Jobs list can be checked. For details, refer to "Checking job settings" on page 10-7.
[Deleted Jobs] button [Finished Jobs] button [All Jobs] button (displayed on the Job History list of the Print tab)		Touch to select the type of jobs displayed in the Job List screen. Change the display mode by touching the appropriate button.
[Detail] button		Touch to display screens for checking the status, results, error details, user name, queued time, completed time, number of original pages and number of copies for jobs in the Current Jobs and Job History lists. For details, refer to "Checking job details" on page 10-8.
[↑] and [↓] buttons		When there are more jobs than the seven that can be displayed at one time, touch these arrows to display jobs higher or lower in the list (higher or lower in the printing order).
[Close] button		Touch to quit Job List mode and returns to the screen that was displayed before [Job List] was touched.

^{*1}Displayed when the Current Jobs list is displayed.

The following information is listed in the Print tab.

Item Name	Description
No.	Job identification number assigned when the job is queued
User Name	Displays the type (source) of the job. "COPY" is displayed for copy jobs.
Status (Current Jobs list only)	Displays the status of the job
Document Name	Displays the name of the file for print jobs sent from the computer. If user authentication settings have been applied, the names of documents are not displayed for other users. The name of confidential documents is not displayed.
Time Stored	Displays the time that the job was queued.
Org.	Displays the number of pages in the original.
Copies	Displays the number of Copies to be printed. With jobs listed as "Printing" in the Current Jobs list, a count of the number of Copies printed is displayed.
Result (Job History list only)	Displays the result of the operation (Job Complete, Deleted Due To Error, Deleted by User, Reset Modes).

10.1.4 Left panel Job List

The job list or the job status can be displayed in the left panel of the main screen.

- 1 Touch [Job List] in the left panel.
A list of jobs appears in the left panel.

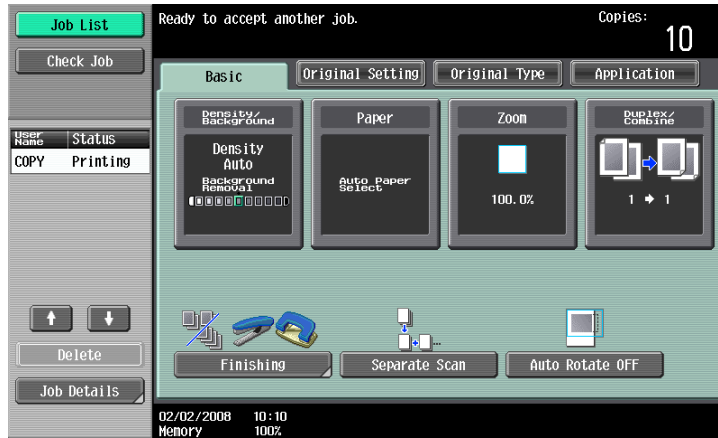

- If the "Job Display Setting" parameter (available from the User Setting screen) is set to "Status Display", the job status is displayed in the left panel.

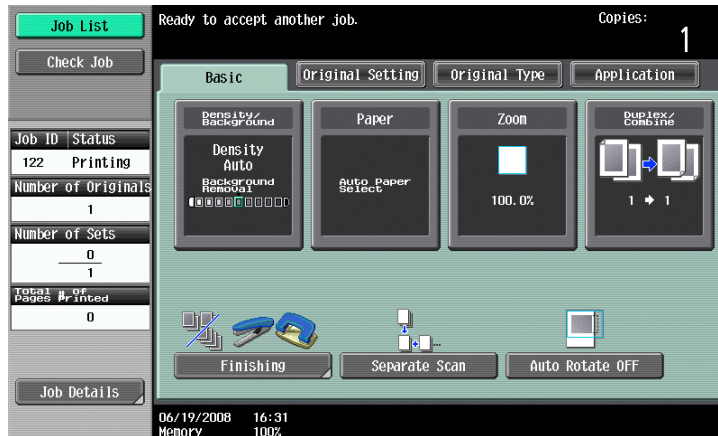

- To display the Job List screen, touch [Job Details].
- To delete a job, select the job from the job list, and then touch [Delete].
- When there are more jobs than the seven that can be displayed at one time, touch [↑] and [↓] to display other jobs.



Detail

As the factory default, the display for the sub display area is that when "Job Display Setting" is set to "List Display".

For details on specifying the default display for the left panel and the display method for the left panel Job List, refer to "Custom Display Settings" on page 11-17.

10.2 Performing operations on jobs

10.2.1 Deleting a job

A queued job or job being printed (job on the Current Jobs list) can be deleted.

- 1 Touch [Job List] in the left panel, and then touch [Job Details].



The Job List screen appears.

- 2 In the Print tab, display the job to be deleted.
 - Jobs on the Job History list cannot be deleted.
- 3 Select the job to be deleted, and then touch [Delete].
 - If the job to be deleted is not displayed, touch [↑] or [↓] until the desired job is displayed.
 - If an incorrect job was selected, select a different job or touch the button for the selected job again to deselect it.

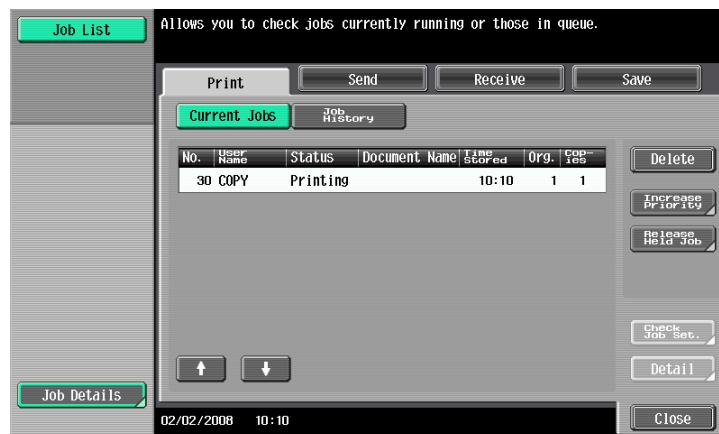

A message requesting confirmation to delete the job appears.

- 4 Check the information that is displayed, touch [Yes] if the correct job is indicated, and then touch [OK].

- To quit deleting the job, touch [No], and then touch [OK].

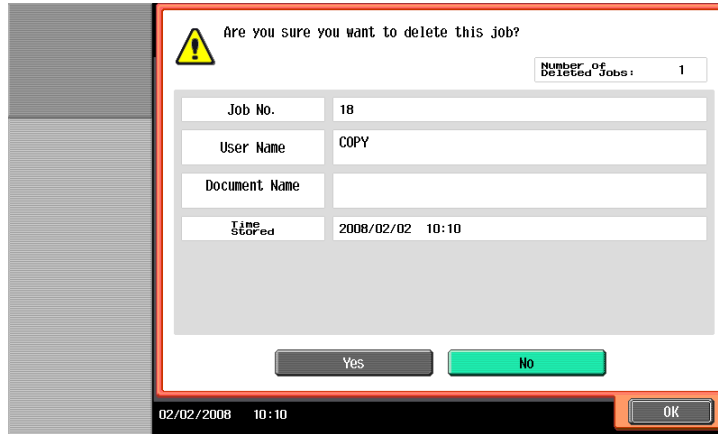

The screen displayed before [Delete] was touched appears again, and the job is deleted from the Current Jobs list.

- 5 Touch [Close] or press the [Reset] key.
The Basic screen appears again.



Note

If user authentication settings have been applied and the machine is set so that jobs cannot be deleted by other users, the job is not deleted.

A job being performed can also be deleted by selecting the job in the sub display area, then touching [Delete].

10.2.2 Checking job settings

Job settings for stored jobs, jobs being printed, jobs queued to be printed and held jobs can be checked.

- 1 Touch [Job List] in the left panel, and then touch [Job Details].
The Job List screen appears.
- 2 Display the list containing the job whose settings are to be checked.
- 3 Select the job to be checked, and then touch [Check Job Set.].
 - If an incorrect job was selected, select a different job or touch the button for the selected job again to deselect it.
 - The contents and number of Job Settings screens differ depending on the job that was selected.
 - The upper number to the left of [←Back] indicates the number of the currently displayed screen. The lower number indicates the total number of screens.
 - To display the previous screen, touch [←Back]. To display the next screen, touch [Forward→].
 The Check Job Settings screen appears.

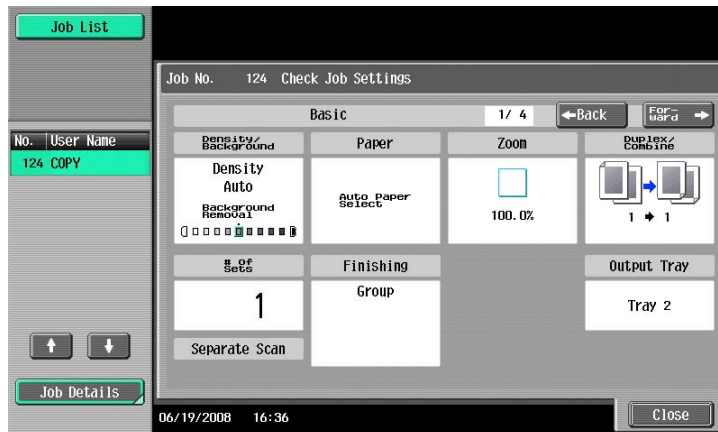

- 4 After checking the settings, touch [Close] or press the [Reset] key.
 - To return to the screen displayed before [Check Job Set.] was touched, touch [Close].
 - To return to the Basic screen, press the [Reset] key.

10.2.3 Checking job details

The following information can be checked from the Job List screen.

- **Print tab**
 Status (Receiving, Print Wait, Printing, Stop Print, Print Err, Job Stored)^{*1}, Result (Job Complete, Deleted Due To Error, Deleted by User, Reset Modes)^{*2}, Error Details^{*2}, User Name, Document Name, Output Tray, hours (Job Start, Job End^{*2}), Prints (Original, # of Sets), External Server Information
- **Send tab**
 Status (Transferring, Waiting, Dialing, Waiting To Redial)^{*1}, Result (Job Complete, Deleted Due To Error, Deleted by User)^{*2}, User Name, Document Name, Address Type (E-Mail, FTP, File (SMB), TWAIN, Fax, Others), Dest (Detail^{*3}), hours (Job Start, Type), Prints (Document), External Server Information
- **Receive tab**
 Status (Receiving, Dialing (only with polling reception), Print Wait, Printing, Stop Print, Print Err, Saving to Memory)^{*1}, Result (Job Complete, Deleted Due To Error, Deleted by User, Reset Modes)^{*2}, Error Details^{*2}, User Name, Document Name, Output Tray, hours (Job Start, Type), Prints (Document), box number, box name, External Server Information
- **Save tab**
 Status (Receiving, Saving to Memory)^{*1}, Result (Job Complete, Deleted Due to Error, Deleted by User, Reset Modes)^{*2}, Error Details^{*2}, User Name, User Box (box number/box name), hours (Job Start), Prints (Original)

^{*1} Displayed only for jobs on the Current Jobs list

^{*2} Displayed only for jobs on the Job History list

^{*3} Displayed only for jobs on the Currently Jobs list transmitted to multiple destinations

- 1 Touch [Job List] in the left panel, and then touch [Job Details].
 The Job List screen appears.
- 2 Display the list containing the job whose details are to be checked.
- 3 Select the job whose details are to be checked, and then touch [Detail].
 - If an incorrect job was selected, select a different job or touch the button for the selected job again to deselect it.
 The Detail screen appears.



- 4 After the desired information has been checked, touch [Close] or press the [Reset] key.
 - To return to the screen displayed before [Job Details] was touched, touch [Close].
 - To return to the Basic screen, press the [Reset] key.



Detail

To delete the job, touch [Delete] in the Detail screen.

If [Detail] appears in the Detail screen for a job selected from the Send tab, detailed information is available on the multiple destinations that the data was sent to with broadcast transmission. To view the information, touch [Detail].

10.2.4 Displaying the Current Jobs list (stored jobs and active jobs)

The Current Jobs list of received print jobs for Copy mode and Fax mode and for computer printing is displayed.

- 1 Touch [Job List] in the left panel, and then touch [Job Details].
The Job List screen appears.
- 2 Touch the button for the desired list.

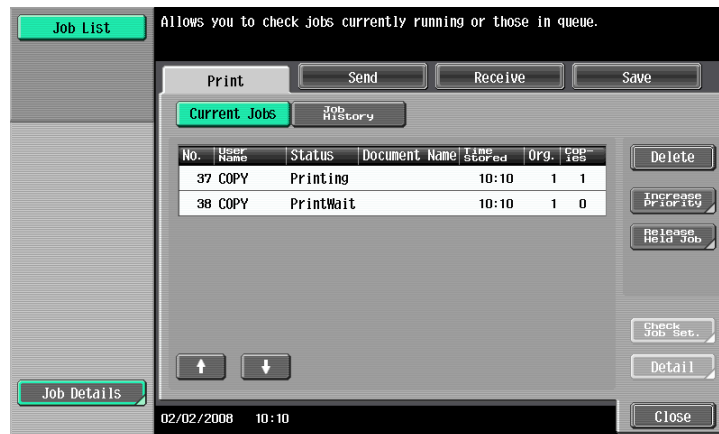

- To display the stored jobs, touch [Release Held Job] to display the Release Held Job screen.



To return to the Job List screen, touch [Cancel].



Detail

For details on the function of each button, refer to ["Job List screens" on page 10-3](#).

From the Release Held Job screen, proof copies of stored jobs can be printed. For details, refer to ["Printing a proof copy of a stored job" on page 10-11](#).

Stored jobs can be printed from the Release Held Job screen. For details, refer to ["Printing a stored job" on page 10-12](#).

To give priority for output to a job, touch [Increase Priority] in the Current Jobs list. For more details, refer to ["Increasing printing priority" on page 10-14](#).

10.2.5 Displaying the Job History list

- 1 Touch [Job List] in the left panel, and then touch [Job Details].
The Job List screen appears.

- 2 Touch [Job History].
The Job History list of the Print tab appears.
- 3 Touch the button for the desired list.

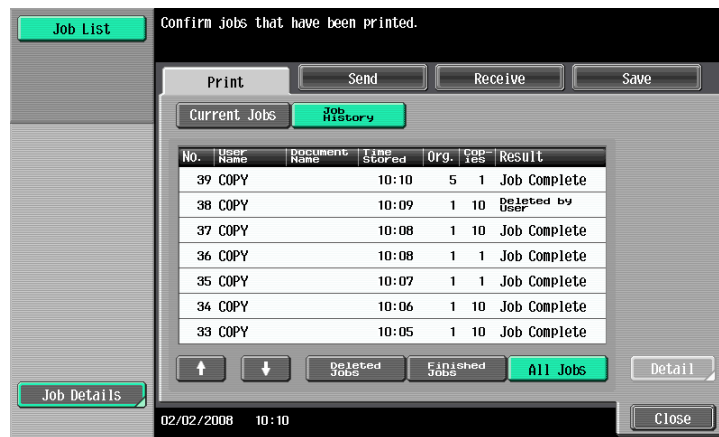

- Deleted Jobs: Displays only jobs that were deleted before they were finished.
- Finished Jobs: Displays only jobs that were correctly completed.
- All Jobs: Displays all jobs.

10.2.6 Printing a proof copy of a stored job

A single copy of a stored job can be printed in order to be checked.

The Held Jobs list contains jobs such as those for which a proof copy was being printed when the automatic system reset operation was performed.



Note

For details on displaying the screen, refer to *"Displaying the Current Jobs list (stored jobs and active jobs)" on page 10-9.*

- 1 In the Current Jobs list of the Print tab, touch [Release Held Job].

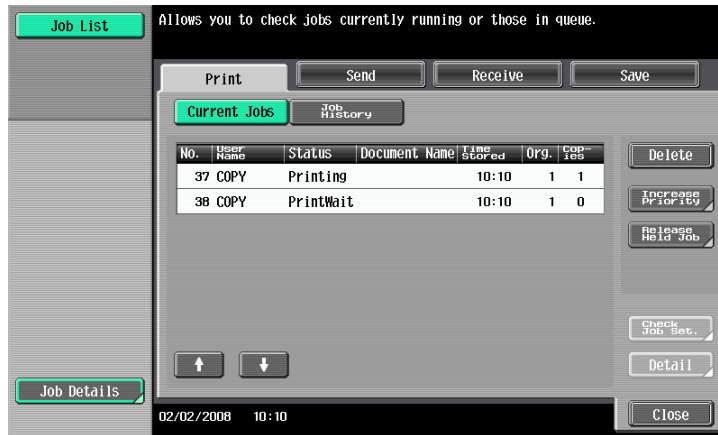

The Release Held Job screen appears.

- 2 From the job list, select the job whose proof copy is to be printed, and then touch [Proof Copy] key.



- If the job to be removed from the Held Jobs list is not displayed, touch [↑] or [↓] until the desired job is displayed.
- If an incorrect job was selected, touch the button for the selected job again to deselect it.
- After the single proof copy is printed, check the print result.

? How is printing of a proof copy stopped?

→ Press the [Stop] key.



Detail

To change the settings, touch [Check Job Set.] in the Release Held Job screen. For details, refer to *"Printing a stored job" on page 10-12.*

10.2.7 Printing a stored job

A job is removed from the Held Jobs list and printed.



Note

For details on displaying the screen, refer to "[Displaying the Current Jobs list \(stored jobs and active jobs\)](#)" on page 10-9.

- 1 In the Current Jobs list of the Print tab, touch [Release Held Job].

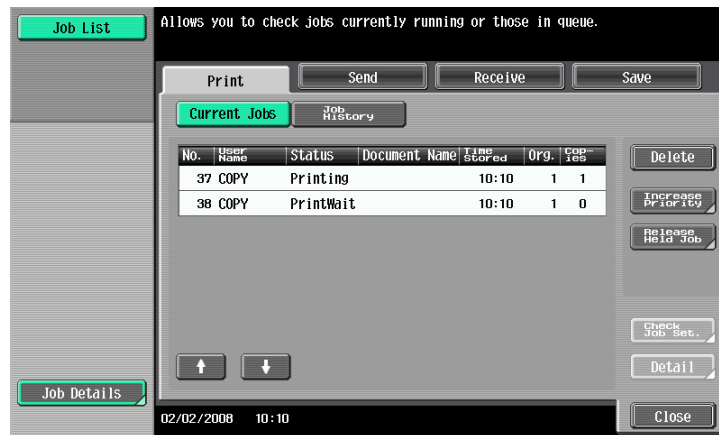

The Release Held Job screen appears.

- 2 Select the job to be removed from the Held Jobs list.



- If the job to be removed from the Held Jobs list is not displayed, touch [↑] and [↓] until the desired job is displayed.
- If an incorrect job was selected, select a different job or touch the button for the selected job again to deselect it.
- To continue without changing the specified copy settings, continue with step 5.

- 3 Touch [Change Setting].

The Change Setting screen appears.

- 4 In the Change Setting screen, change the copy settings as desired, and then touch [OK].



- ? Is there more information about the settings?
→ Refer to the appropriate section.
- ? Can a proof copy be printed?
→ For details on printing a proof copy, refer to ["Printing a proof copy of a stored job" on page 10-11.](#)

- 5 In the Release Held Job screen, touch [OK] or press the [Start] key.

The stored job appears in the Current Jobs list and is printed.

- ? How is the removal of a job from the Held Jobs list stopped?
→ Touch [Cancel].

10.2.8 Increasing printing priority

The next job to be printed after the current job being printed can be selected.

If an Administrator mode parameter was set so that the output priority of jobs cannot be changed, [Increase Priority] does not appear and the output priority of the jobs cannot be specified.

If the job currently being printed can be interrupted, printing is interrupted and printing of the job given priority begins. Printing of the interrupted job is automatically restarted once printing for the job given priority is finished.

If the job currently being printed cannot be interrupted (a job has already been interrupted or a job was already given priority), printing is interrupted after printing for the current job is finished.

- 1 Display the Job History list of the Print tab.
 - For details on displaying the screen, refer to "[Displaying the Current Jobs list \(stored jobs and active jobs\)](#)" on page 10-9.
- 2 Touch [Increase Priority].

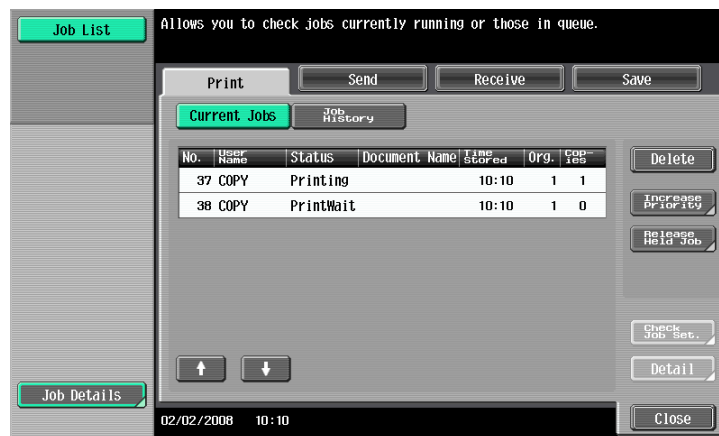

The Increase Priority screen appears.

- 3 In the job list, touch the button for the job to be given priority to select it, and then touch [OK].

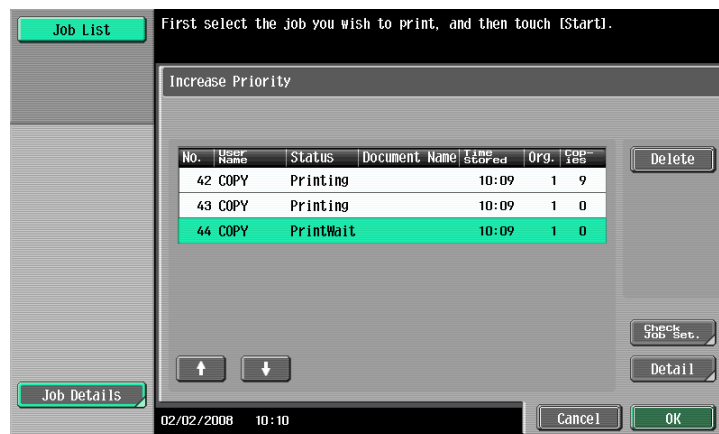

- If the job to be given priority is not displayed, touch [↑] and [↓] until the desired job is displayed.
- If an incorrect job was selected, select a different job or touch the button for the selected job again to deselect it.

The selected job moves to the top of the list and printing of the job begins.

? How can the change in the printing priority be stopped?

→ Touch [Cancel].

11

Utility mode

11 Utility mode

11.1 Overview of Utility mode parameters

11.1.1 List of registration information and parameters

This section describes the buttons available when the [Utility/Counter] key is pressed.



Note

The buttons that appear in the Utility mode parameters differ depending on the specified settings.

List of Utility mode parameters

First-level menu	Second-level menu	Third-level menu	Details
[1] One-Touch/User Box Registration	[1] Create One-Touch Destination	[1] Address Book	Refer to " Create One-Touch Destination " on page 11-7.
		[2] Group	
		[3] E-mail Settings	
	[2] Create User Box	[1] Public/Personal User Box	Refer to " Create User Box " on page 11-7.
		[2] Bulletin Board User Box	
		[3] Relay User Box	
	[3] Limiting Access to Destinations	[1] Apply Levels/Groups to Destinations	Refer to " Limiting Access to Destinations " on page 11-7
[2] User Settings	[1] System Settings	[1] Language Selection	Refer to " System Settings " on page 11-15.
		[2] Measurement Unit Settings	
		[3] Paper Tray Settings	
		[4] Power Save Settings	
		[5] Output Settings	
		[6] Blank Page Print Settings	
		[7] Density for Original Type	
		[8] Page Number Print Position	
	[2] Custom Display Settings	[1] Copier Settings	Refer to " Custom Display Settings " on page 11-17.
		[2] Scan/Fax Settings	
		[3] Copy Screen	
		[4] Fax Active Screen	
		[5] Color Selection Settings	
		[6] Left Panel Display Default	
[7] Search Option Settings			

First-level menu	Second-level menu	Third-level menu	Details
	[3] Copier Settings	Auto Booklet ON when Fold & Staple (Machine with SD-507 only) Auto Zoom For Combine/Booklet Auto Sort/Group Selection Default Copy Settings Default Enlarge Display Settings When AMS Direction is Incorrect Separate Scan Output Method Enlargement Rotation Auto Zoom (Platen) Auto Zoom (ADF) Specify Default Tray when APS Off Select Tray for Insert Sheet Tri-Fold Print Side Print Jobs During Copy Operation Automatic Image Rotation Printed side when copying 1 sheet from Original Glass	Refer to "Copier Settings" on page 11-18.
	[4] Scan/Fax Settings	Black Compression Level Default Scan/Fax Settings	Refer to "Scan/Fax Settings" on page 11-20.
	[5] Printer Settings	[1] Basic Settings [2] Paper Setting [3] PCL Settings [4] PS Setting [5] XPS Settings [6] TIFF Image Paper Setting [7] Print Reports [8] Image Shift Settings [9] Stamp Settings	Refer to "Printer Settings" on page 11-32.
	[6] Change Password		Changes the password for the user who is currently logged on. Refer to "Change Password" on page 11-20.
	[7] Change E-Mail Address	E-Mail Address	Changes the e-mail address for the user who is currently logged on. Refer to "Change E-Mail Address" on page 11-21
	[8] Toner Supply		Refer to "Toner Supply" on page 11-21.

First-level menu	Second-level menu	Third-level menu	Details
[3] Administrator Settings	[1] System Settings	[1] Power Save Settings	Refer to " System Settings " on page 11-23.
		[2] Output Settings	
		[3] Date&Time Settings	
		[4] Daylight Saving Time	
		[5] Weekly Timer Settings	
		[6] Restrict User Access	
		[7] Expert Adjustment	
		[8] List/Counter	
		[9] Reset Settings	
		[0] User Box Settings	
		(next screen)	
		[1] Size Settings	
	[2] Stamp Settings		
	[3] Blank Page Print Settings		
	[4] Page Number Print Position		
	[5] Skip Job Setting		
	[2] Administrator/Machine Settings	[1] Administrator Registration	Refer to " Administrator/Machine Settings " on page 11-28.
		[2] Input Machine Address	
	[3] One-Touch/User Box Registration	[1] Create One-Touch Destination	Refer to " One-Touch/User Box Registration " on page 11-29.
		[2] Create User Box	
[3] One-Touch/User Box Registration List			
[4] Maximum Number of User Boxes			
[4] User Authentication/Account Track	[1] General Settings	Refer to " User Authentication/Account Track " on page 11-29.	
	[2] User Authentication Settings		
	[3] Account Track Settings		
	[4] Print without Authentication		
	[5] Print Counter List		
	[6] External Server Settings		
	[7] Limiting Access to Destinations		
	[8] Authentication Device Setting		

First-level menu	Second-level menu	Third-level menu	Details
	[5] Network Settings	[1] Network Setting [2] TCP/IP Settings [3] NetWare Settings [4] HTTP Server Settings [5] FTP Settings [6] SMB Settings [7] LDAP Settings [8] E-Mail Settings [9] SNMP Settings [0] AppleTalk Settings (next screen) [1] Bonjour Setting [2] TCP Socket Settings [3] Network Fax Settings [4] WebDAV client Settings [6] Web Service Settings [7] Detail Settings	Refer to "Network Settings" on page 11-31.
	[6] Copier Settings	Auto Zoom (Platen) Auto Zoom (ADF) Specify Default Tray when APS Off Select Tray for Insert Sheet Print Jobs During Copy Operation Tri-Fold Print Side Automatic Image Rotation Printed side when copying 1 sheet from Original Glass	Refer to "Copier Settings" on page 11-18.
	[7] Printer Settings	USB Timeout Network Timeout Print XPS Errors	Refer to "Printer Settings" on page 11-20.
	[8] Fax Settings	[1] Header Information [2] Header/Footer Position [3] Line Parameter Setting [4] TX/RX Settings [5] Function Settings [6] PBX Connection Setting [7] Report Settings [8] Job Settings List [9] Multi Line Setting [0] Network Fax Setting	Refer to "Fax Settings" on page 11-33.

First-level menu	Second-level menu	Third-level menu	Details	
	[9] System Connection	[1] Open API Settings	Refer to " System Connection " on page 11-33.	
	[0] Security Settings	[1] Administrator Password	Refer to " Security Settings " on page 11-33.	
		[2] User Box Administrator Setting		
		[3] Administrator Security Levels		
		[4] Security Details		[4] Security Detail provides [Audit Log Setting]. For details, please contact your service representative.
		[5] Enhanced Security Mode		
		[6] HDD Settings		
		[7] Function Management Settings		
		[8] Stamp Settings		
		[0] Driver Password Encryption Setting		
		(next screen)		
	[1] Flash Memory Lock Password			

11.2 Registering a destination

This section describes the function and main registration parameters that can be specified after pressing the [Utility/Counter] key, then touching [One-Touch/User Box Registration].

11.2.1 Create One-Touch Destination

Parameter	Description
Address Book	Specify settings for registering fax and scan destinations. For details, refer to the User's Guide [Network Scan/Fax/Network Fax Operations].
Group	
E-mail Settings	



Note

If user authentication settings have been specified, [1 One-Touch Destination/User Box Registration] cannot be selected when no user has logged on. However, after a user has logged on, [1 One-Touch Destination/User Box Registration] appears.

Items for registering fax destinations appear only when the fax kit is installed or when Internet fax functions are available.

11.2.2 Create User Box

Parameter	Description
Public/Personal User Box	Specify settings for registering user box destinations. For details, refer to the User's Guide [Box Operations] and the User's Guide [Network Scan/Fax/Network Fax Operations].
Bulletin Board User Box	
Relay User Box	



Note

[2 Bulletin Board User Box] and [3 Relay User Box] appear only when the fax kit is installed or when Internet fax functions are available.

11.2.3 Limiting Access to Destinations

Access Level

Using the Access Level settings on this machine, the security of registered destinations can be managed by permitting/prohibiting viewing of the destination information or fax transmissions to the destination.

Access permission levels can be set to one of six levels between 0 and 5, with the higher number indicating higher security.



Note

The access level that is set for user, destination, and group level on the Limiting Access to Destinations can be used when user authentication settings have been specified.

Level settings

The access permission level can be specified for each user and destination. The destinations that can be accessed by users can be limited according to the access permission levels specified for the user and destination. For example, a level 2 user can access destinations in levels 0 through 2, but cannot access destinations in levels 3 through 5. A level 5 user can access all destinations in levels 0 through 5.

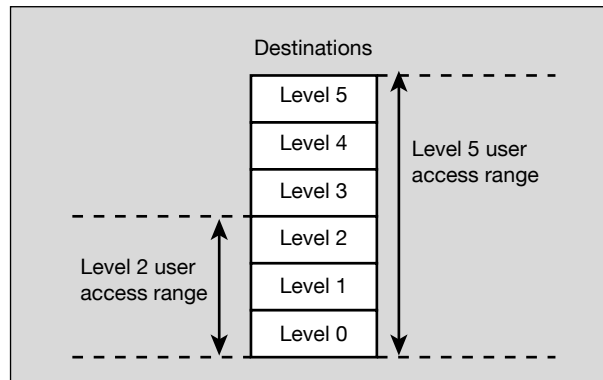

Note

For details on the access permission level settings for user, refer to ["User Authentication/Account Track" on page 11-29](#).

As a default, the access permission level specified for public users is level 0.

Group

In addition to users and destinations, groups with access permissions can be created and given a name. When users and destinations are registered in these groups, a destination registered in a group can be accessed by users registered to the same group.

In addition, by applying access permission levels to groups, users not registered in a group can be given access permissions according to the conditions of the specified level.

A destination can be registered in only one group. However, a user can be registered in multiple groups.

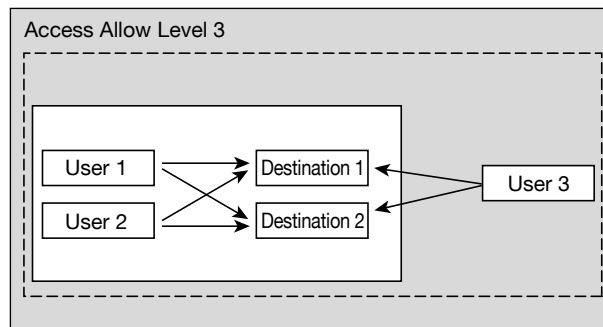

Specifying a group setting

- 1 Display the Administrator Settings screen.
 - For details on displaying the Administrator Settings screen, refer to ["Displaying the Administrator Settings screen" on page 11-36](#).
- 2 Touch [4 User Authentication/Account Track].
The User Authentication/Account Track screen appears.

- 3 Touch [7 Limiting Access to Destinations].
The Limiting Access to Destinations screen appears.
- 4 Touch [1 Create Group].
 - A maximum of 20 groups can be registered.
 - In the Create Group screen, touch the button for a group, touch [Details], and then check the destinations and names of users belonging to that group.
 The Create Group screen appears.
- 5 Touch the button for the desired group, and then touch [Edit].



The Edit screen appears.

- 6 Touch [Group Name].



The Group Name screen appears.

- 7 Type in the group name (up to 24 characters), and then touch [OK].
 - For details on typing in text, refer to ["Entering text" on page 14-2](#).

The group name is specified.



- 8 Select the desired access permission level.
The access permission level for the group is specified.
- 9 Touch [OK].

Specifying a destination level

- 1 Display the Administrator Settings screen.
 - For details on displaying the Administrator Settings screen, refer to ["Displaying the Administrator Settings screen" on page 11-36](#).
- 2 Touch [4 User Authentication/Account Track].
The User Authentication/Account Track screen appears.
- 3 Touch [7 Limiting Access to Destinations].
The Limiting Access to Destinations screen appears.
- 4 Touch [2 Apply Levels/Groups to Destinations].
The Apply Levels/Groups to Destinations screen appears.
- 5 Touch the button for the desired destination.

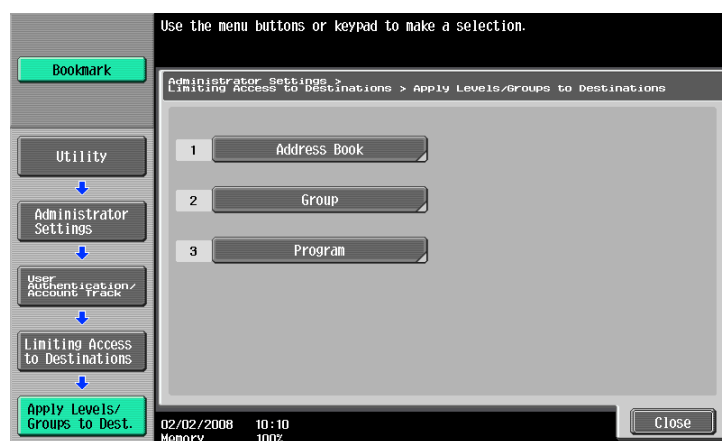

- For an address book destination, touch the index button for the first letter of the destination, and then search for the destination.



6 Touch the button for the desired setting.

- Either an access permission level or an access permission group can be specified for each destination.
- Only one access permission group can be specified for a single destination.
- To specify the destination group, touch [Apply Group]. Touch the button for the desired group, and then touch [OK].
- Touch the button for a group, touch [Details], and then check the destinations and names of users belonging to that group.

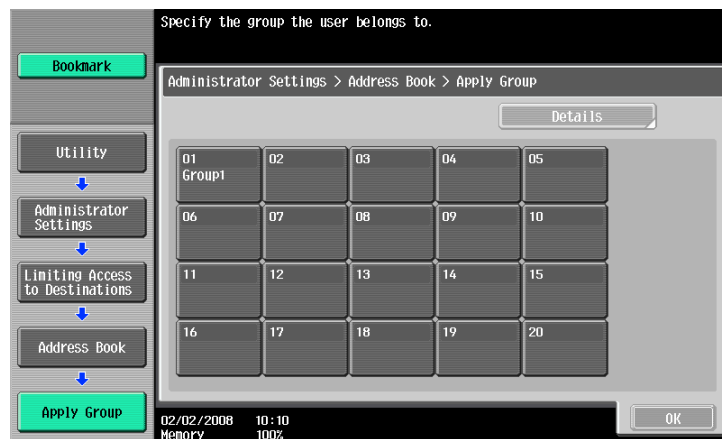

- To specify the destination level, touch [Apply Level]. Touch the button for the desired level, and then touch [OK].

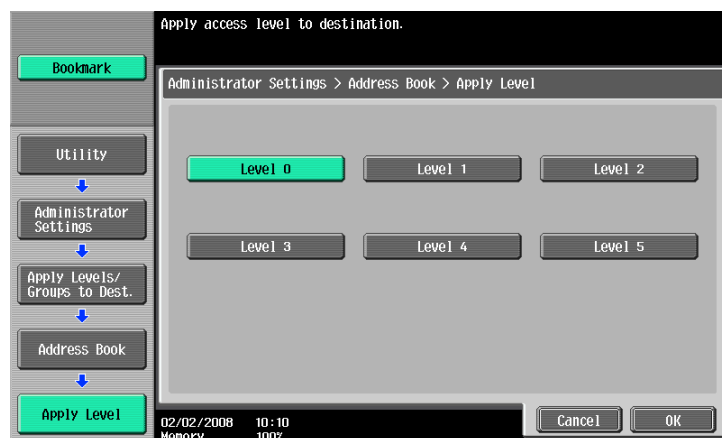

Specifying a user level

- 1 Display the Administrator Settings screen.
 - For details on displaying the Administrator Settings screen, refer to "[Displaying the Administrator Settings screen](#)" on page 11-36.
- 2 Touch [4 User Authentication/Account Track].
The User Authentication/Account Track screen appears.
- 3 Touch [7 Limiting Access to Destinations].
The Limiting Access to Destinations screen appears.
- 4 Touch [3 Apply Levels/Groups to Users].
The Apply Levels/Groups to Users screen appears.
- 5 Select either "Public User Box" or "Personal User Box" as the user type, and then touch the button for the desired User.



- The "Public User Box" and "Personal User Box" settings appear only when access by a public user is permitted.
- If use by a public user is permitted, "Public" appears as the user name. As the default, level 0 is specified.

- 6 Touch the button for the desired setting.
 - Both an access permission level and an access permission group can be specified for each user.
 - A single user can be registered in multiple access permission groups.
 - To specify the user group, touch [Apply Group]. Touch [Yes], touch the button for the desired group, and then touch [OK].
 - Touch the button for a group, touch [Details], and then check the destinations and names of users belonging to that group.



- To specify the user level, touch [Apply Level]. Touch [Yes], touch the button for the desired level, and then touch [OK].



11.2.4 Displaying the destination registration screen

Follow the procedure described below to display the One-Touch/User Box Registration screen by pressing [Utility/Counter] key.

- 1 Press the [Utility/Counter] key.

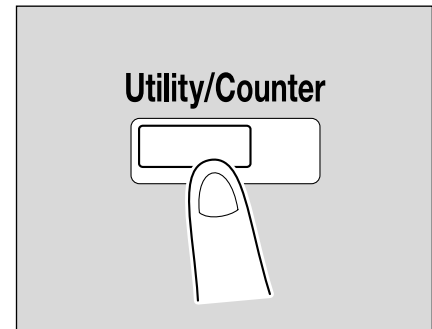

- 2 Touch [1 One-Touch/User Box Registration].

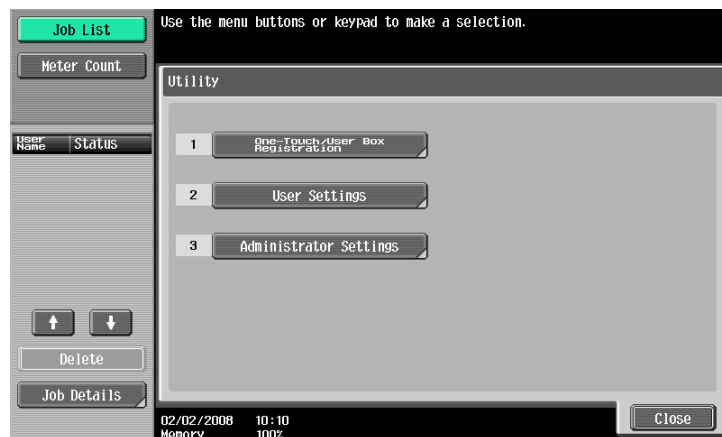

- An item can also be selected by pressing the key in the keypad for the number beside the desired button.
For [1 One-Touch/User Box Registration], press the [1] key in the keypad.

The One-Touch/User Box Registration screen appears.

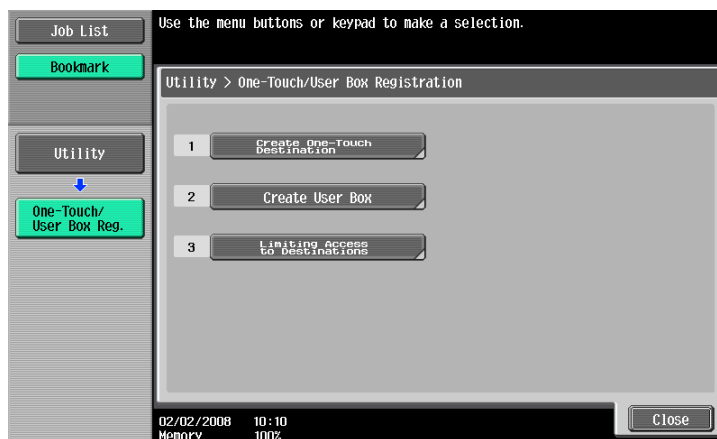

Note

To finish specifying settings in the Utility mode, press the [Utility/Counter] key. Otherwise, exit the Utility mode by touching [Close] in each screen until the screen for the Copy, Fax/Scan or Box mode appears.

11.3 Specifying user settings

This section describes the function and main registration parameters that can be specified after pressing the [Utility/Counter] key, then touching [User Settings].

11.3.1 System Settings

Language Selection

Description	Default Setting
Select the language of the touch panel message.	English

Measurement Unit Settings

Description	Default Setting
Select one of the following as the measurement units in which values are displayed in the touch panel. mm (Numerical Value), inch (Numerical Value), inch (Fraction)	inch (Fraction)

Paper Tray Settings

Parameter	Description	Default Setting
Auto Tray Selection Settings	Select the paper trays that are selected automatically when the "Auto" Paper setting is specified. In addition, specify the priority of the paper trays when the auto tray switch operation is performed.	Tray priority order: Tray 1 → Tray 2 → Tray 3 → Tray 4 → Bypass → LCT*
Auto Tray Switch ON/OFF	Select whether or not a paper tray loaded with paper of the same size is selected automatically when a paper tray that was selected manually becomes empty while printing copies.	Restrict
No Matching Paper in Tray Setting	Select the operation that is performed when there is no paper of the corresponding size in the specified paper tray. <ul style="list-style-type: none"> Stop Printing (Tray Fixed): The machine stops operating. Switch Trays (Tray Priority): When the corresponding size or type of paper is not loaded in the specified paper tray, a different paper tray is selected if it contains paper of the corresponding size. 	Stop Printing (Tray Fixed)
Print Lists	Select the paper tray used for printing lists, such as the sales counter and consumables indicators.	Tray 1, 1-Sided
Paper Type/Size Settings	Specify the paper type to be use for each tray.	Plain Paper
Post Inserter Alert Display Setting	Specify whether to display the paper size and paper orientation during the tray display or an alarm indication for the post inserter.	Yes

* Appears when the optional Large Capacity Unit LU-405/406 is installed.

Power Save Settings

Parameter	Description	Default Setting
Low Power Mode Settings	Specify the desired length of time (between 1 and 240 minutes) until the machine enters Power Save mode.	15 minutes
Sleep Mode Settings	Specify the desired length of time (between 1 and 240 minutes) until the machine enters Sleep mode.	60 minutes

**Note**

[Low Power Mode Settings] appears only if the "Administrator Security Levels" parameter in Administrator mode is set to [Level 1], [Level 2].

**Detail**

For details on the "Administrator Security Levels" parameter, refer to "[Security Settings](#)" on [page 11-33](#).

Output Settings

Parameter	Description	Default Setting
Print/Fax Output Setting	Specify settings for faxing and printing. For details, refer to the User's Guide [Network Scan/Fax/Network Fax Operations] and the User's Guide [Print Operations].	
Output Tray Setting	Select the copy output tray for each type of job (copies, printouts, reports and faxes).	Copy: Tray 1 Print: Tray 1 Print Reports: Tray 2 Fax: Tray 2

**Note**

The "Output Tray Settings" parameter is available only if the optional finisher is installed.

Blank Page Print Settings

Description	Default Setting
Select whether or not stamps and overlays are printed on blank pages.	Do Not Print

Density for Original Type

Description	Default Setting
Shift the exposure level darker/lighter within 6 levels for each original type, which will be reflected to 9 levels of the Density setting available on the Basic screen.	Text/Photo: 3 Text: 3 Photo: 3 Dot Matrix Original: 2

Page Number Print Position

Description	Default Setting
Specify the print position of the stamp on back pages when duplex printing and booklet are used in combination.	All the same

**Note**

[Output Settings], [Blank Page Print Settings], [Density for Original Type], and [Page Number Print Position] appear only if the "Administrator Security Levels" parameter in Administrator mode is set to "Level 2".

11.3.2 Custom Display Settings

Copier Settings

Parameter	Description	Default Setting
Default Tab	Specify the default display for the Basic screen in Copy mode. <ul style="list-style-type: none"> Basic: This is the normal basic display. Quick Copy: Displays all selectable items for the "Paper" function, "Zoom" function and "Duplex/Combine" function. The normal Basic screen appears as a different tab. 	Basic
Shortcut Key 1	Shortcut keys for frequently used Application functions can be added to the Basic screen of Copy mode.	OFF
Shortcut Key 2		

Scan/Fax Settings

Parameter	Description
Default Tab	Specify settings for faxing and scanning. For details, refer to the User's Guide [Network Scan/Fax/Network Fax Operations].
Program Default	
Address Book Index Default	
Shortcut Key 1	
Shortcut Key 2	
Default Address Book	

Copy Screen

Parameter	Description	Default Setting
Copy Operating Screen	Select the screen that is displayed while printing. <ul style="list-style-type: none"> Yes: A screen for reserving a copy job appears while printing and, if [Program Next Job] is touched, a job can be reserved. No: A copy job can be reserved while the Basic screen in Copy mode is displayed. 	No

Fax Active Screen

Parameter	Description
TX Display	Specify settings for faxing. For details, refer to the User's Guide [Network Scan/Fax/Network Fax Operations].
RX Display	

Color Selection Settings

Parameter	Description	Default Setting
Select Color	Select the color that indicates that the button is selected.	Green

Left Panel Display Default

Parameter	Description	Default Setting
Left Panel Display Default	Select the information displayed as the default in the left panel. <ul style="list-style-type: none"> Job List: A list of the jobs that are being performed and queued to be performed is displayed. Check Job Settings: The currently specified copy settings are displayed. 	Job List
Job Display Setting	Select the job list information displayed in the left panel. <ul style="list-style-type: none"> List Display: A list of the jobs that are being performed and queued to be performed is displayed. Status Display: The progress of the job being performed is displayed. 	List Display

Search Option Settings

Parameter	Description	Default Setting
Uppercase and Lowercase Letters	Select whether or not to differentiate between uppercase and lowercase letters.	Differentiate
Search Option Screen	Select whether or not to display [Uppercase and Lowercase Letters] setting in the advanced search.	OFF

11.3.3 Copier Settings

Parameter	Description	Default Setting
Auto Booklet ON when Fold & Staple	Select whether or not the "Booklet" function is selected automatically when the "Center Staple & Fold" setting is selected. This parameter is available only if optional finisher is installed.	Auto Select Booklet
Auto Zoom For Combine/Booklet	Select whether or not the preset zoom ratios are automatically selected when the "Auto" Paper setting is selected and a combined copy setting or the "Booklet" function is selected. <ul style="list-style-type: none"> Auto Display Zoom Ratio: The following zoom ratios are specified. 2in1, Booklet: 64.7% 4in1: 50.0% 8in1: 32.3% Off: The zoom ratio is not selected automatically. 	Auto Display Zoom Ratio
Auto Sort/Group Selection	Select whether or not the "Sort" setting is automatically selected when 2 or more copies are set to be printed in a single job. <ul style="list-style-type: none"> Yes: When an original is loaded into the automatic document feeder and the [Start] key is pressed, the "Group" setting is automatically selected if the original consists of only one page, and the "Sort" setting is automatically selected if the original consists of two or more pages. No: The "Sort" or "Group" setting is not selected automatically. 	Yes
Default Copy Settings	Specify the default settings for Copy mode. The copy settings selected when the machine is turned on (the power switch is set to "I") or the [Reset] key is pressed can be specified. <ul style="list-style-type: none"> Current Setting: The settings specified from the touch panel before Utility mode was entered are set as the default settings for Copy mode. Factory Default: The factory default settings are set as the default settings for Copy mode. 	Factory Default
Default Enlarge Factory Default	Specify the default settings for Enlarge Display mode. <ul style="list-style-type: none"> Current Setting: The settings specified in the Enlarge Display mode before Utility mode was entered are set as default settings for the Enlarge Display mode. Factory Default: The factory default settings are set as the default settings for the Enlarge Display mode. 	Factory Default
When AMS Direction is Incorrect	Select whether or not printing continues when the paper and original orientations are different with the "Auto Paper Select" setting selected. <ul style="list-style-type: none"> Print: The Zoom setting is automatically set and the copy is printed on paper of the specified size in the specified orientation. Delete Job: The job is deleted, and no copies are printed. 	Print

Parameter	Description	Default Setting
Separate Scan Output Method	Select whether copies are printed as the original is being scanned or after the entire original has been scanned when scanning an original in separate batches or when scanning a multiple-page document from the original glass. <ul style="list-style-type: none"> Page Print: Printing of copies that can be printed begins while the original is being scanned. Batch Print: Printing begins after all pages of the original have been scanned. 	Page Print
Enlargement Rotation	Select whether an image that exceeds 11-11/16 inch in the main scanning direction (left/right direction on the original glass and ADF) is rotated when the copies are printed. <ul style="list-style-type: none"> Allow: An enlargement rotation is performed. However, this is applied only when the "Black" Color setting is selected. Restrict: The enlargement rotation is prohibited, regardless of the selected Color setting. 	Restrict
Auto Zoom (Platen)	Select whether or not the "Auto" Zoom setting is automatically selected when a paper tray is selected (except when the "Auto" Paper setting is selected) while an original is placed on the original glass.	OFF
Auto Zoom (ADF)	Select whether or not the "Auto" Zoom setting is automatically selected when a paper tray is selected (except when the "Auto" Paper setting is selected) while an original is loaded into the ADF.	ON
Specify Default Tray when APS Off	Select which paper tray is selected when the "Auto" Paper setting is canceled. <ul style="list-style-type: none"> Tray Before APS ON: The paper tray that was being used before the "Auto" Paper setting was selected is selected. Default Tray: Tray 1 is used. 	Tray Before APS ON
Select Tray for Insert Sheet	Select the default paper tray loaded with paper for the cover pages (front cover), inserted pages and chapter title pages.	Tray 2
Tri-Fold Print Side	Whether to fold copies with the printed surface inward or outward can be selected when copies are output tri-folded. This function can be used if the optional Finisher FS-610 is installed.	Outside
Print Jobs During Copy Operation	Select whether or not print data or fax data can be accepted for printing while a copy operation is being performed. <ul style="list-style-type: none"> Accept: Print data and fax data can be accepted and printed. Receive Only: Print data and fax data is printed after the copy operation is finished. 	Accept
Automatic Image Rotation	Select whether or not the image is automatically rotated when the original and copy paper orientations are different. <ul style="list-style-type: none"> When Auto Paper / Auto Zoom / Reduce is set: If the "Auto" Paper setting, "Auto" Zoom setting or a Reduce setting is selected, the image is automatically rotated to fit the orientation of the paper. When Auto Paper / Auto Zoom is set: If the "Auto" Paper setting or "Auto" Zoom setting is selected, the image is automatically rotated to fit the orientation of the paper. When Auto Zoom / Reduce is set: If the "Auto" Zoom setting or a Reduce setting is selected, the image is automatically rotated to fit the orientation of the paper. When Auto Zoom is set: If the "Auto" Zoom setting is selected, the image is automatically rotated to fit the orientation of the paper. 	When Auto Paper/Auto Zoom is set
Printed side when copying 1 sheet from Original Glass	Specify whether the copies of originals scanned from the original glass are output with the printed sides facing up or down. <ul style="list-style-type: none"> Face Down: Copies are output with the printed sides facing down. Face UP: Copies are output with the printed sides facing up. 	Face Down



...

Note

[Auto Zoom (Platen)], [Auto Zoom (ADF)], [Specify Default Tray when APS Off], [Select Tray for Insert Sheet], and [Automatic Image Rotation] appear only if the "Administrator Security Levels" parameter in Administrator mode is set.

[Print Jobs During Copy Operation] appears only if the "Administrator Security Levels" parameter in Administrator mode is set to "Level 2".

When the Enlarge Display mode is selected, the [Default Enlarge Display Setting] button appears to allow specifying the default settings of the copy and fax/scan operations in the Enlarge Display mode.

**Detail**

For details on the "Administrator Security Level" parameter, refer to ["Security Settings" on page 11-33](#).

For details on the default settings and the factory default settings, refer to [page 1-29](#).

To change the default settings for Fax/Scan mode, press the [Fax/Scan] key, enter Utility mode, and then select a setting for this parameter.

11.3.4 Scan/Fax Settings

Parameter	Description
Black Compression Level	Specify settings for scanning. For details, refer to the User's Guide [Network Scan/Fax/Network Fax Operations].
Default Scan/Fax Settings	

11.3.5 Printer Settings

Parameter	Description
Basic Settings	Specify settings for printing. For details, refer to User's Guide [Print Operations (IC-208)].
Paper Settings	
PCL Settings	
PS Setting	
XPS Settings	
TIFF Image Paper Setting	
Print Reports	The Print function settings can be printed as a report. For details, refer to User's Guide [Print Operations (IC-208)].
Image Shift Settings	Make adjustment on Image Shift function used in Printer mode. For details, refer to the User's Guide [Print Operations (IC-208)].
Stamp Settings	Specify settings for Stamp function used in Printer mode. For details, refer to the User's Guide [Print Operations (IC-208)]. Available paper types depend on the paper tray.

11.3.6 Change Password

Description
The password for the user who is currently logged on can be changed. After typing in the current password, type in the new password. This parameter is available when "User Authentication" is set to "ON (MFP)".

11.3.7 Change E-Mail Address

Description

The e-mail address for the user who is currently logged on can be changed. This parameter appears only when a user other than a public user is logged on.



Note

[Change E-Mail Address] appears only if the "Administrator Security Levels" parameter in Administrator mode is set to "Level 2"

11.3.8 Toner Supply

Description

When the toner density becomes low, the density level can be restored while the machine is stopped.

11.3.9 Displaying the User Settings screen

Follow the procedure described below to display the User Settings screen by pressing [Utility/Counter] key.

- 1 Press the [Utility/Counter] key.

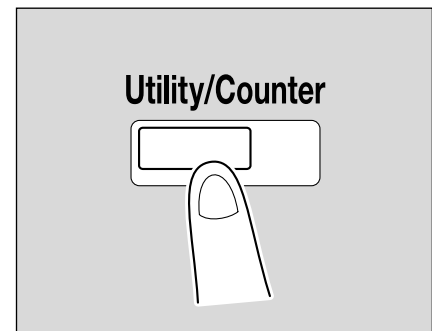

- 2 Touch [2 User Settings].
 - An item can also be selected by pressing the key in the keypad for the number beside the desired button.
For [2 User Settings], press the [2] key in the keypad.

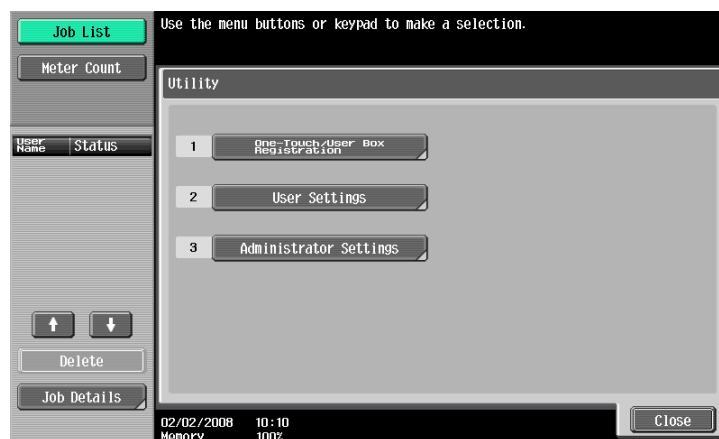

The User Settings screen appears.



Note

To finish specifying settings in the Utility mode, press the [Utility/Counter] key. Otherwise, exit the Utility mode by touching [Close] in each screen until the screen for the Copy or Box mode appears.

11.4 Specifying administrator settings

This section describes the function and main registration parameters that can be specified after pressing the [Utility/Counter] key, then touching [Administrator Settings].

11.4.1 System Settings

Power Save Settings

Parameter	Description	Default Setting
Low Power Mode Settings	Specify the desired length of time (between 1 and 240 minutes) until the machine enters Power Save mode.	15 minutes
Sleep Mode Settings	Specify the desired length of time (between 1 and 240 minutes) until the machine enters Sleep mode.	60 minutes
Power Save Key	Select which low power mode is entered when the [Power Save] key is pressed. <ul style="list-style-type: none"> Low Power: The touch panel goes off and the machine enters a mode where it conserves energy. Sleep: Although the machine conserves more energy in Sleep mode than in Power Save mode, the machine must warm up when Sleep mode is canceled, therefore taking more preparation time than Power Save mode. 	Low Power
Enter Power Save Mode	Specify settings for faxing. For details, refer to the User's Guide [Network Scan/Fax/Network Fax Operations].	Normal

Output Settings

Parameter	Description	Default Setting
Print/Fax Output Setting	Specify settings for faxing and printing. For details, refer to the User's Guide [Network Scan/Fax/Network Fax Operations] and the User's Guide [Print Operations].	
Output Tray Settings	Select the finishing tray for each type of job (copies, printouts, reports and faxes).	Copy: Tray 1 Printer: Tray 1 Print Reports: Tray 2 Fax: Tray 2
Shift Output Each Job	Select whether or not printed copies are fed out shifted when "Off-set" is selected while a finisher is installed. <ul style="list-style-type: none"> Yes: Pages are fed out shifted. No: Pages are fed out without being shifted. 	Yes

Date/Time Settings

Description	Default Setting
Specify the current date and time. In addition, the time zone can be set between -12:00 and 13:00 (in 30-minute increments).	Time Zone: +00:00

Daylight Saving Time

Description	Default Setting
Select whether or not the machine's internal clock observes daylight saving time. If "Yes" is selected, a setting appears so that the length of time for adjusting the current time can be set. The length of time applied for daylight saving time can be set between 1 and 150 minutes in 1-minute increments.	No

Weekly Timer Settings

Parameter	Description	Default Setting
Weekly Timer ON/OFF Settings	Select whether or not the weekly timer is used.	OFF
Time Settings	Specify the time of each day that the machine is turned on/off.	-
Date Settings	Specify the individual dates or the days of the week that the machine is turned on/off.	-
Select Time for Power Save	If the machine is turned off at a specific time, for example, during the lunch break, the time for turning the machine off and on can be specified.	No
Password for Non-Business Hours	If the machine is turned off with the weekly timer function, select whether or not use is limited with a password. In addition, if "Yes" is selected, specify the password that must be entered.	No

**Detail**

If the weekly timer is set, the machine will be turned on/off at the specified time. Settings can be specified to require a password in order to turn the machine on or to allow fax and print jobs to be received after the machine has been turned off by the timer.

Various weekly timer settings in the Weekly Timer Settings screen can be combined. For details on the various settings, refer to ["Overview of weekly timer settings" on page 11-38](#).

Restrict User Access

Parameter	Description	Default Setting	
Copy Program Lock Settings	Select the registered copy programs that are prevented from being changed or deleted.	-	
Delete Saved Copy Program	Select the registered copy programs to be deleted.	-	
Restrict Access to Job Settings	Changing Job Priority	Select whether or not to allow the print priority of jobs to be changed.	Allow
	Delete Other User Jobs	Select whether or not jobs from other users can be deleted when the user authentication settings have been specified.	Restrict
	Registering and Changing Addresses	Select whether or not to allow registered destinations to be changed.	Allow
	Changing Zoom Ratio	Select whether or not to allow stored zoom ratios to be changed.	Allow
	Change the "From" Address	Select whether or not to allow the specified From address to be changed.	Allow
	Change Registered Overlay	Select whether or not to allow registered image overlays to be changed.	Allow
Restrict Operation	Restrict Broadcasting	Select whether to prevent multiple recipients from being specified for fax transmissions.	OFF

Expert Adjustment

Parameter		Description	Default Setting
Density for Original Type		Shift the exposure level darker/lighter within 5 levels for each original type, which will be reflected to 9 levels of the Density setting available on the Basic screen.	Text: 3 Text/Photo: 3 Photo: 3 Dot Matrix Original: 2
Erase Adjustment	Non-Image Area Erase	Select the condition for Non-Image Area Erase to function.	Except Original Glass ×1.0
	Non-Image Area Erase Setting	Select the setting method, erasing mode, and original density for the Non-Image Area Erase function.	Erase Setting: Specify How to Erase: Rectangular Original Density: Standard
	ADF Frame Erase	Specify the erasing width for the ADF Frame Erase function.	3 mm
Printer Adjustment	Leading Edge Adjustment	Adjust the starting print position between -3.0 mm and +6.0 mm at the leading edge of the paper (with respect to the paper feed direction). Adjustments can be specified for each paper type.	0.0 mm
	Centering	Adjust the starting print position between -6.4 mm and +6.3 mm at the left edge of the paper (with respect to the paper feed direction).	0.0 mm
	Vertical Adjustment	If the copy image is distorted (stretched or compressed), the paper feed speed and printing speed can be synchronized to adjust the distortion of the copy image between -1.35 and +5.00.	0.0%
	Horizontal Adjustment	If the copy image is distorted (stretched or compressed), the zoom ratio in the transverse feed direction of the original can be adjusted between -1.0% and +1.0%.	0.0%
2nd-Side Size Adjustment	Adjust the zoom ratio for the back side of double-sided copies for each paper tray. Adjust Ratio:[No Selection], [-0.1%], [-0.2%], [-0.3%]	No Selection	

Parameter		Description	Default Setting
Finisher Adjustment	Center Staple Position ^{*1}	Adjust the stapling position (between -12, 8 mm and 12, 7 mm) when printing with the "Center Staple & Fold" setting.	0.0 mm
	Half-Fold Position ^{*1}	Adjust the folding position (between -12, 8 mm and 12, 7 mm) when printing with the "Center Staple & Fold" setting.	0.0 mm
	Punch Vertical Position Adjustment ^{*2}	Adjust the vertical position of the punched holes between -5.0 mm and 5.0 mm.	0.0 mm
	Punch Unit Vertical Position Adjustment ^{*3}	Adjust the vertical position of the punched holes between - 5.0 mm and 5.0 mm for each paper size.	0.0 mm
	Punch Horizontal Position Adjustment ^{*2}	Adjust the horizontal position of the punched holes between -5.0 mm and 5.0 mm.	0.0 mm
	Punch Unit Horizontal Position Adjustment ^{*3}	Adjust the horizontal position of the punched holes between - 5.0 mm and 5.0 mm.	0.0 mm
	Punch Resist Loop Size Adjustment ^{*2}	Adjust the hole-punching shift for double-sided printing and outputting cover pages between -16.0 mm and 16.0 mm.	0.0 mm
	1st Z-Fold Position Adjustment ^{*3}	Adjust the 1st folding position between - 12.8 mm and + 12.7 mm for each paper size.	0.0 mm
	2nd Z-Fold Position Adjustment ^{*3}	Adjust the 2nd folding position between - 12.8 mm and + 12.7 mm for each paper size.	0.0 mm
	Tri-Fold Position Adjustment ^{*1}	Adjust the folding positions (between -12.8 mm and 12.7 mm) when printing with the "Tri-Fold" setting.	0.0 mm
	2-Position Staple Pitch Adjustment ^{*1}	Adjust the distance (between 128 mm and 160 mm) between staples when printing with the "2 Position" Staple setting ("Staple" and "Center Staple & Fold").	128 mm
Post Inserter Feeder Size Adjustment ^{*4}	Adjust the sensor for detecting the size of paper loaded in the paper trays of the post inserter.	-	
Scanner Area	Scanner Adjustment: Leading Edge	Adjust the starting scan position between -2.0 mm and +6.0 mm at the leading edge of the original (with respect to the image scan direction).	0.0 mm
	Scanner Adjustment: Centering	Adjust the starting scan position between -3.0 mm and +3.0 mm at the left edge of the original (with respect to the image scan direction).	0.0 mm
	Vertical Adjustment	If the scanned image is distorted (stretched or compressed), the zoom ratio in the feed direction of the original in the scanner area can be adjusted between -2.0% and +2.0%.	1.00%
ADF Centering	Adjust the center position in the transverse feed direction of the original between -3.0 mm and +3.0 mm.	0.0 mm	

^{*1} Appears only when Finisher FS-610 is installed.

^{*2} Appears only when finisher is installed with punch kit.

^{*3} Appears only when Z folding unit is installed.

^{*4} Appears only when post inserter is installed.



Detail

[Finisher Adjustment] appears only when an optional finisher is installed.

The Finisher Adjustment parameters that are available differ depending on the model of the installed finisher.

List/Counter

Parameter		Description
Management List	Job Settings List	The machine settings can be printed.
Paper Size/Type Counter		Store combinations of paper sizes and paper types to be counted.

Reset Settings

Parameter		Description	Default Setting
System Auto Reset		Specify the desired length of time until the automatic system reset operation is performed. <ul style="list-style-type: none"> Priority Mode: Select the setting ("Copy" or "Scan/Fax") for the mode that the machine enters when the automatic system reset operation is performed. System Auto Reset Time: Specify the setting (between 1 and 9 minutes or "OFF") for the desired length of time until the automatic system reset operation is performed. 	Priority Mode: Copy System Auto Reset Time: 1 Minute
Auto Reset		Select the setting (between 1 and 9 minutes or "OFF") for the desired length of time until the automatic panel reset operation is performed for each mode (Copy and Scan/Fax).	Copy: 1 Minute Scan/Fax: 1 Minute
Job Reset	When Account is changed	Select whether or not the settings are reset (initialized) when the user has changed. This machine detects that the user has changed when the optional key counter has been removed or when the user has logged off if user authentication or account track settings are specified.	Reset
	When original is set on ADF	Select whether or not the settings are reset when an original is loaded into the automatic document feeder.	Do Not Reset
	Next Job	Staple Setting: Select whether the same Staple setting from the previous job is set or the setting is canceled when that job begins and the settings for the next job can be specified.	OFF
Original Set/Bind Direction: Select whether the same Original Direction and Binding Position settings from the previous job are set or the settings are canceled when that job begins and the settings for the next job can be specified.		OFF	
Reset Data After Job: Select whether the same settings for a scan operation or for a fax transmission from the previous job are set or the settings are canceled when that job is completed and the settings for the next job can be specified. (However, even if "OFF" is selected, the destination is cleared.)		ON	
System Auto Reset for Proof Copy		Select whether or not to activate the automatic system reset after the proof copy operation is performed.	No

**Reminder**

Even if the System Auto Reset Time is [OFF], the System Auto Reset function is activated after 1 minute of no operation of the machine during the User Authentication or Account Track. However, when in the Enlarge Display mode, the System Auto Reset function is not activated.

If user authentication settings have been specified or "Enhanced Security Mode" has been set to "ON", the logoff from Administrator mode or user authentication mode will be performed according to the "System Auto Reset Time" parameter.

User Box Settings

Parameter	Description	Default Setting
Delete Unused User Box	Specify settings for using boxes. For details, refer to the User's Guide [Box Operations].	
Delete Secure Print Documents		
Auto Delete Secure Document	Specify settings for using boxes. For details, refer to the User's Guide [Box Operations].	1 day
Encrypted PDF Delete Time		1 day
Touch & Print Delete Time		1 day
Document Hold Setting		ON
External Memory Function Settings	Save Document	OFF
	Print Document	ON

Stamp Settings

Parameter	Description	Default Setting
Header/Footer Settings	Program or delete header/footer settings.	-
Fax TX Settings	Select whether or not the stamp settings are canceled when a fax is sent.	Cancel

Blank Page Print Settings

Description	Default Setting
Select whether or not stamps and overlays are printed on blank pages when a Stamp/Composition function is set.	Do Not Print

Page Number Print Position

Description	Default Setting
Specify the print position of the stamp on back pages when duplex printing and booklet are used in combination.	All the Same

Skip Job Setting

Parameter	Description	Default Setting
Fax	Select whether or not to skip jobs for the fax transmission.	ON
other than Fax	Select whether or not to skip jobs for other functions than fax transmission.	ON

11.4.2 Administrator/Machine Settings

Parameter	Description
Administrator Registration	Specify the administrator information displayed in the Service Representative/Administrator Information screen of the Help screen and the From address for sending e-mail from the machine.
Input Machine Address	Register the name of the machine and its e-mail address. The registered machine name is added to the names of files that are sent and to originals saved in user boxes. As the factory default, the machine name is specified as "KMBT_751/601". The registered e-mail address is used with Internet faxing.



Note

When entering the device name while registering the machine address, do not use characters that cannot be used by the operating system.

11.4.3 One-Touch/User Box Registration

Parameter	Description
Create One-Touch Destination	Specify settings for registering fax, scan and user box destinations. For details, refer to the User's Guide [Network Scan/Fax/Network Fax Operations] and the User's Guide [Box Operations].
Create User Box	
One-Touch/User Box Registration List	The lists of address book destinations, group destinations, program destinations and titles/text can be printed to be checked. For details, refer to the User's Guide [Network Scan/Fax/Network Fax Operations].
Maximum Number of User Boxes	Specify the maximum number of user boxes for each user. For details, refer to the User's Guide [Box Operations].

11.4.4 User Authentication/Account Track

General Settings

Description	Default Setting
<p>Specify user authentication and account track settings in order to control the use of this machine.</p> <ul style="list-style-type: none"> • User Authentication: Select either "External Server Authentication" or "ON (MFP)" as the user authentication method. To quit user authentication, select "OFF". • Public User Access: Select whether or not the machine can be used by an unauthenticated user. This cannot be selected if "User Authentication" is set to "OFF". • The machine can be used without authentication if [ON (Without Login)] is touched when logging on as a public user. When logging on as an authorized user, the [Access] key must be pressed first to display the authentication screen. • Account Track: Select whether or not account tracking is used to control the machine. • Account Track Input Method: To authenticate using an account name and password, touch [Account Name & Password]. To authenticate using only a password, touch [Password Only]. No setting can be selected when "Account Track" is set to "OFF". If both user authentication and account track settings are specified, "Account Name & Password" cannot be selected. • Synchronize User Authentication & Account Track: Select whether or not user authentication and group authentication are synchronized. This appears only when "User Authentication" is set to "External Server Authentication" or "ON (MFP)" and "Account Track" is set to "On". • When # of Jobs Reach Maximum: To stop the job being printed and begin printing the next job when the limit specified for account track or user authentication is reached, touch [Skip Job]. To stop the all jobs when the limit is reached, select [Stop Job]. • Number of User Counters Assigned: Adjust the number of users and accounts that can be registered. Example: When "Number of User Counters Assigned" is set to "50", 950 accounts can be registered. • Ticket Hold Time Setting: Specify the desired length of holding time (between 1 and 60 minutes) of Kerberos authentication ticket. The holding time setting is applied when Active Directory is selected as the authentication server type. 	<p>User Authentication: OFF Public User Access: Restrict Account Track: OFF Account Track Input Method: Account name & password Synchronize User Authentication & Account Track: Synchronize When # of Jobs Reach Maximum: Skip Job Number of User Counters Assigned: 500 Ticket Hold Times Settings: 60 min</p>

User Authentication Settings

Parameter		Description	Default Setting
Administrative Settings	User Name List	Select whether or not a list of user names is displayed in the user authentication screen.	OFF
	Default Function Permission	Operations that are possible with this machine can be limited when authenticating with an external server.	Copy: Allow Scan: Allow Fax: Allow Print: Allow User Box: Allow Print Scan/Fax TX: Allow Save to External Memory: Allow
User Registration		Register the users of this machine. In addition, the password, number of prints allowed, authentication information and function permissions can be specified for each user.	-
User Counter		The copy, print and fax/scan use for each user can be checked.	-

**Note**

The user authentication parameters appear only if "User Authentication" on the General Settings screen is set to any setting other than "OFF".

Account Track Settings

Parameter	Description
Account Track Registration	Register the accounts using this machine. In addition, the password and number of prints allowed can be specified for each account.
Account Track Counter	The copy, print and scan/fax use for each account can be checked.

**Note**

The account track parameters appear only if "Account Track" on the General Settings screen is set to "ON".

Print Without Authentication

Description	Default Setting
Select whether or not printing is permitted without specifying a user or account. If printing is permitted, prints are counted for public users.	Restrict

Print Counter List

Description	Default Setting
This parameter appears only if user authentication or account track settings have been specified. The use for each user or account can be checked.	Paper Tray: Tray 1 Simplex/Duplex: 1-sided Print Item: All Info.

External Server Settings

Description
Specify the external server that performs user authentication.

Limiting Access to Destinations

Parameter	Description
Create Group	Groups for permitting access to destinations can be registered and edited.
Apply Levels/Groups to Destinations	The access permission level and the group with access permissions can be specified for each destination.

Parameter	Description
Apply Levels/Groups to Users	The access permission level and the group with access permissions can be specified for each user.

Authentication Device Settings

Parameter	Description	Default setting
General Settings	Specify the settings for the installed authentication unit. <ul style="list-style-type: none"> Card Authentication: Select the IC card type and operation settings. Bio Authentication: Select the beep and operation settings. 	When the authentication unit (IC card type) has been installed: IC Card Type: FeliCa Operation Settings: Card Authentication When the authentication unit (biometric type) has been installed: Beep Sound: ON Operation Settings: 1-to-many authentication
Touch & Print Setting	Select the printing operation for Touch & Print. <ul style="list-style-type: none"> ON: Select this setting to select whether all jobs or only one job is printed. OFF: Select this setting to prevent printing with Touch & Print. 	ON: Print All Jobs
Logoff Settings	Select whether or not the user is logged off after a scan or fax is sent or after the copy original is scanned.	Do not log off



Detail

The Authentication Device Settings parameters are available only if the optional authentication unit is installed.

The authentication units of the IC card type and the biometric type cannot be installed at the same time.

Using Touch & Print, a user can print a job sent from a computer by positioning their finger or IC card on the authentication unit.

11.4.5 Network Settings

Parameter	Description
Network Setting	Specify settings for using the network. For details, refer to the User's Guide [Network Scan/Fax/Network Fax Operations].
TCP/IP Settings	
NetWare Settings	
HTTP Server Settings	
FTP Settings	
SMB Settings	
LDAP Settings	
E-mail Settings	
SNMP Settings	
AppleTalk Settings	
Bonjour Setting	
TCP Socket Settings	
WebDAV Client Settings	
Web Service Settings	
Detail Settings	
Network Fax Settings	Specify settings for using network faxing. For details, refer to the User's Guide [Network Scan/Fax/Network Fax Operations].

11.4.6 Copier Setting

Parameter	Description	Default Setting
Auto Zoom (Platen)	Select whether or not the "Auto" Zoom setting is automatically selected when a paper tray is selected (except when the "Auto" Paper setting is selected) while an original is placed on the original glass.	OFF
Auto Zoom (ADF)	Select whether or not the "Auto" Zoom setting is automatically selected when a paper tray is selected (except when the "Auto" Paper setting is selected) while an original is loaded into the ADF.	ON
Specify Default Tray when APS Off	Select which paper tray is selected when the "Auto" Paper setting is canceled. <ul style="list-style-type: none"> Tray Before APS ON: The paper tray that was being used before the "Auto" Paper setting was selected is selected. Default Tray: Tray 1 is used. 	Tray Before APS ON
Select Tray for Insert Sheet	Select the default paper tray loaded with paper for the cover pages (front cover), inserted pages and chapter title pages.	Tray 2
Print Jobs During Copy Operation	Select whether or not print data or fax data can be accepted for printing while a copy operation is being performed. <ul style="list-style-type: none"> Accept: Print data and fax data can be accepted and printed. Receive Only: Print data and fax data is printed after the copy operation is finished. 	Accept
Tri-Fold Print Side	Whether to fold copies with the printed surface inward or outward can be selected when copies are output tri-folded. This function can be used if the optional Finisher FS-610 is installed.	Outside
Automatic Image Rotation	Select whether or not the image is automatically rotated when the original and copy paper orientations are different. <ul style="list-style-type: none"> When Auto Paper / Auto Zoom / Reduce is set: If the "Auto" Paper setting, "Auto" Zoom setting or a Reduce setting is selected, the image is automatically rotated to fit the orientation of the paper. When Auto Paper / Auto Zoom is set: If the "Auto" Paper setting or "Auto" Zoom setting is selected, the image is automatically rotated to fit the orientation of the paper. When Auto Zoom / Reduce is set: If the "Auto" Zoom setting or a Reduce setting is selected, the image is automatically rotated to fit the orientation of the paper. When Auto Zoom is set: If the "Auto" Zoom setting is selected, the image is automatically rotated to fit the orientation of the paper. 	When Auto Paper/Auto Zoom is set
Printed side when copying 1 sheet from Original Glass	Specify whether the copies of originals scanned from the original glass are output with the printed sides facing up or down. <ul style="list-style-type: none"> Face Down: Copies are output with the printed sides facing down. Face UP: Copies are output with the printed sides facing up. 	Face Down

11.4.7 Printer Settings

Parameter	Description
USB Timeout	Specify settings for registering print destinations. For details, refer to the User's Guide [Print Operations].
Network Timeout	
Print XPS Error	

11.4.8 Fax Settings

Parameter	Description
Header Information	Specify settings for registering fax destinations. For details, refer to the User's Guide [Network Scan/Fax/Network Fax Operations].
Header/Footer Position	
Line Parameter Setting	
TX/RX Settings	
Function Settings	
PBX Connection Setting	
Report Settings	
Job Settings List	
Multi Line Setting	
Network Fax Settings	Specify settings for using network faxing. For details, refer to the User's Guide [Network Scan/Fax/Network Fax Operations].



Note

[8 Fax Settings] appears only when the fax kit is installed or when Internet fax functions are available.

11.4.9 System Connection

Parameter	Description
Open API Settings	Specify settings for registering network connections. For details, refer to the User's Guide [Network Scan/Fax/Network Fax Operations].

11.4.10 Security Settings

Administrator Password

Description	Default Setting
The administrator password used to specify the Administrator mode settings can be specified or changed. The administrator password can contain between 0 and 8 digits (characters). If the "Password Rules" parameter is set to "Enabled", only an administrator password with 8 digits can be specified.	12345678

User Box Administrator Setting

Description
Specify settings for using boxes. For details, refer to the User's Guide [Box Operations].

Administrator Security Levels

Description	Default Setting
Specify the range of Administrator mode parameters available to users. <ul style="list-style-type: none"> Level 1: Low Power Mode Settings, Auto Zoom (Platen), Auto Zoom (ADF), Specify Default Tray when APS Off, Select Tray for Insert Sheet, Automatic Image Rotation are available to users. Level 2: Low Power Mode Settings, Output Settings, Density for Original, Page Number Print Position, Blank Page Print Settings, Auto Zoom (Platen), Auto Zoom (ADF), Specify Default Tray when APS Off, Select Tray for Insert Sheet, Automatic Image Rotation, Copy Operating Screen, Change E-Mail Address are available to users. Prohibit: None of the parameters that are available to users with "Level 1" or "Level 2" are available. 	Prohibit

Security Details

Parameter	Description	Default Setting
Password Rules	Select whether or not password rules are applied.	Invalid

Parameter	Description	Default Setting
Prohibited Functions When Authentication Error	Select the operations that are prohibited if user authentication failed. <ul style="list-style-type: none"> Mode 1: Operations cannot be performed for a fixed length of time. Mode 2: When authentication has failed repeatedly, the control panel can no longer be operated. The number of times of failed authentication can be set between 1 and 5. If operation of the control panel is restricted, touch [Release], and then select the items whose operation restrictions are canceled. Users & Accounts: Operations for user authentication and account track Secure Print: Operations for confidential documents User Box: Operations for password-protected boxes SNMP: Operations for SNMP v3 Write user authentication Release Time Settings: Specify the length of time until prohibited operations are automatically unlocked. The time can be set between 1 and 60 minutes. 	Mode 1 Release Time Settings: 5 min.
Confidential Document Access Method	The operation method for confidential documents can be viewed. If "Prohibited Functions When Authentication Failed" is set to "Mode 1", this parameter is set to "Mode 1". If "Prohibited Functions When Authentication Failed" is set to "Mode 2", this parameter is set to "Mode 2". Mode 1: Type in the ID and password for the confidential document, and then select the document. Mode 2: Enter the Secure Print ID, select the document, and then enter the password for authentication.	Mode 1
Manual Destination Input	Select whether or not a recipient can be typed in manually in a recipient input screen.	Allow
Print Data Capture	Select whether or not data for a print job can be captured. For details, refer to the User's Guide [Print Operations].	
Restrict Fax TX	Select whether or not fax transmissions are prohibited.	OFF
Hide Personal Information	Select whether or not the file name and destination are hidden in the job log.	OFF
Display Activity Log	Select whether or not the communication log is displayed.	ON
Delete Job Log	The entire job log can be cleared.	-



Detail

The operation of the "Prohibited Functions When Authentication Error" parameter applies to the following passwords.

User passwords, account passwords, user box passwords, passwords for confidential documents, and the administrator password

If the control panel cannot be operated even after touching [Release] from the "Prohibited Functions When Authentication Error" parameter to specify the items whose operation restrictions are canceled or if an operation is prohibited from a failed attempt to authenticate the administrator password, restart the machine. Restart the machine, wait for the time specified in "Release Time Settings", and then perform the administrator authentication.



Reminder

When the machine is turned off, then on again with the main power switch, wait at least 10 seconds to turn the machine on after turning it off. The machine may not operate correctly if it is turned on immediately after being turned off.

Enhanced Security Mode

Description
Settings necessary for applying enhanced security mode appear. Select whether or not to apply enhanced mode settings when the necessary settings are specified. For details, contact your service representative.

HDD Settings

Parameter	Description	Default Setting
Check HDD Capacity	Information concerning the hard disk capacity is displayed.	
Overwrite Temporary Data	Specify whether or not to overwrite the temporary image data saved on the hard disk with all operations for copying, scanning, faxing and computer printing. For details on the settings, refer to the User's Guide [Box Operations]. By specifying a setting to overwrite temporary data, the area of the hard disk where image data is saved after printing or sending can be overwritten, and the data can be erased. This process prevents disclosure of image data on the hard disk.	NO
Overwrite All Data	Select this parameter to overwrite and delete all data on the entire hard disk in the specified patterns for mode 1 through mode 8 when returning the machine from lease or disposing the machine in order to prevent disclosure of the data. For details on the settings, refer to the User's Guide [Box Operations]. Before performing this operation, contact your service representative.	Mode 1
HDD Lock Password	Specify the password for protecting data on the hard disk. For details, refer to the User's Guide [Box Operations].	
Format HDD	Format the hard disk. For details, refer to the User's Guide [Box Operations].	
HDD Encryption Setting	This setting appears when the optional Security kit is installed. Specify an encryption passphrase to encrypt data in the hard disk. For details, refer to the User's Guide [Box Operations]. When a setting is specified, all data written to the hard disk is encrypted to protect it. If the encryption key is changed, the hard disk will be reformatted.	

Function Management Settings

Parameter	Description	Default Setting
Network Function Usage Settings	Specify settings for network functions that are difficult to count when managing operations.	ON

**Detail**

The following functions cannot be used if "Network Function Usage Settings" is set to "OFF".

PC-FAX transmission

Using the HDD TWAIN driver to view and retrieve documents in user boxes

Using PageScope Box Operator to view and retrieve documents in user boxes

Using PageScope Scan Direct to retrieve documents in user boxes

Using PageScope Job Spooler to view and retrieve documents in user boxes

Box operations using the PageScope Web Connection (The User Box tab does not appear.)

Stamp Settings

Parameter	Description
Apply Stamps	Select whether or not a stamp is added when printing or sending.
Delete Registered Stamp	Select whether or not stamps registered for copy protection can be deleted.

Driver Password Encryption Setting

Description	Default setting
The encryption password for the printer driver can be changed. For details, refer to the User's Guide [Print Operations].	Use Factory Default

11.4.11 Displaying the Administrator Settings screen

Follow the procedure described below to display the Administrator Settings screen by pressing [Utility/Counter] key.

- 1 Press the [Utility/Counter] key.

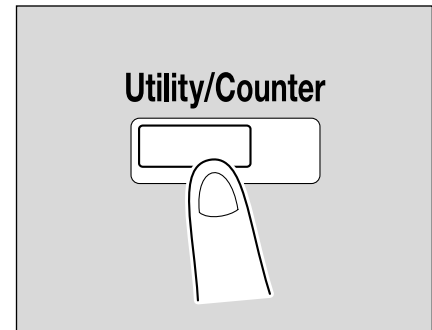

- 2 Touch [3 Administrator Settings].

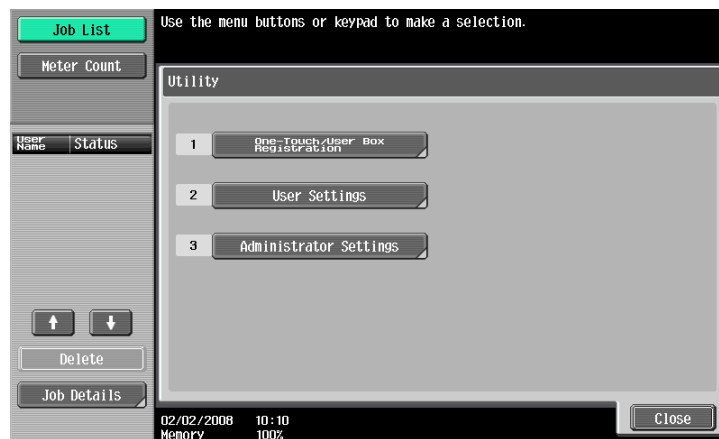

- An item can also be selected by pressing the key in the keypad for the number beside the desired button. For [3 Administrator Setting], press the [3] key in the keypad.

- 3 Type in the administrator password, and then touch [OK].

- For details on typing in text, refer to ["Entering text" on page 14-2](#).



The Administrator Settings screen appears.

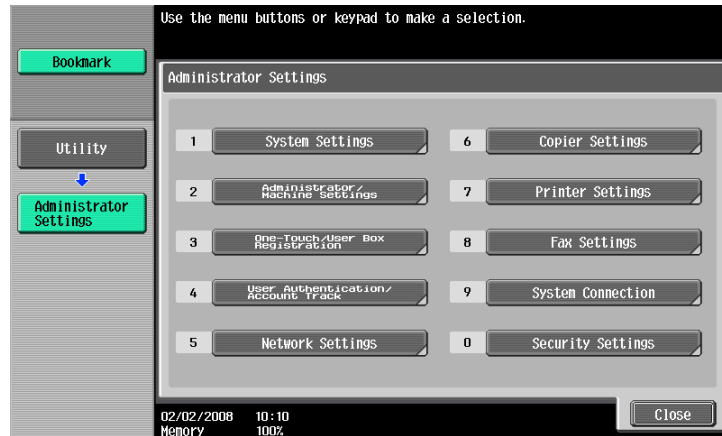

...

Note

To finish specifying settings in the Utility mode, press the [Utility/Counter] key. Otherwise, exit the Utility mode by touching [Close] in each screen until the screen for the Copy, Fax/Scan or Box mode appears.



...

Reminder

The default administrator password is "12345678". The administrator of this machine should change the administrator password.

Be sure to keep the administrator password in a safe place. If the administrator password is lost, it must be specified by the service representative. For details, contact the service representative.

11.5 Overview of weekly timer settings

Various weekly timer settings in the Weekly Timer Setting screen can be combined. A general procedure is described below.

- ✓ If the weekly timer has been set, leave the machine plugged into the electrical outlet even if the machine has been turned off.
- ✓ Press the [Utility/Counter] key, touch [Administrator Settings], then [System Settings], then [Weekly Timer Setting], and correctly specify the necessary settings.

- 1 Set "Weekly Timer ON/OFF Settings" to "ON".
- 2 Specify times for "Time Settings".
- 3 Specify dates for "Date Settings".
- 4 Specify the desired settings for "Select Time for Power Save" and "Password for Non-Business Hours".
The weekly timer is set.

11.6 Finisher Adjustment

11.6.1 Center Staple Position Adjustment

The stapling position when printing with the "Center Staple & Fold" setting can be adjusted for each paper size.



Note

[Center Staple Position Adjustment] does not appear if optional Finisher FS-610 is not installed.

If the angle of the staple must be adjusted, contact your service representative.



Detail

For details on the "Center Staple & Fold" setting, refer to "[Binding copies at the center \("Center Staple & Fold" setting\)](#)" on page 2-67.

For the procedure on adjusting the center folding position, refer to "[Half-Fold Position](#)" on page 11-40.

- ✓ Adjust the center folding position before adjusting the center stapling position.
- ✓ Before making any adjustments, use the "Center Staple & Fold" setting to print a single sample copy. Perform the adjustment while checking the sample that was created.

- 1 Display the Administrator Settings screen.
 - For details on displaying the Administrator Settings screen, refer to "[Displaying the Administrator Settings screen](#)" on page 11-36.
- 2 Touch [1 System Settings].
The System Settings screen appears.
- 3 Touch [7 Expert Adjustment].
The Expert Adjustment screen appears.
- 4 Touch [5 Finisher Adjustment].
The Finisher Adjustment screen appears.
- 5 Touch [1 Center Staple Position].
The Center Staple Position screen appears.

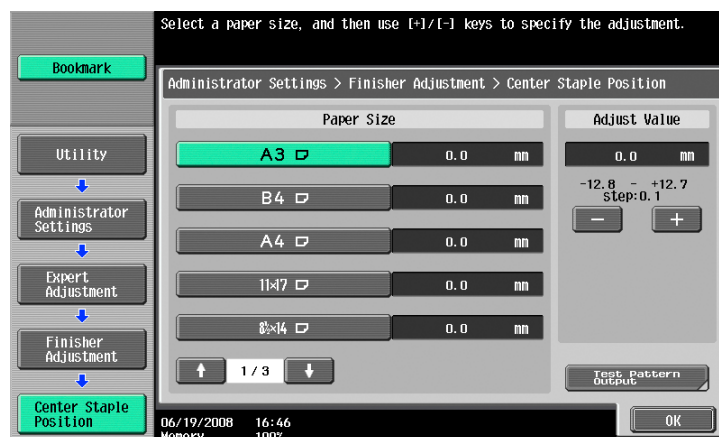

- 6 Touch the button for the paper size to be adjusted.
 - If the paper size to be adjusted is not displayed, touch [↑] and [↓] until the desired paper size is displayed.

- 7** Compare the width of the left pages of the copy sample with the width of the right pages to check for the center of the paper.
- If the staple position is too far to the left of the center of the paper, touch [+] to increase the adjustment (between 0.1 mm and 12.7 mm).
 - Each time [+] or [-] is touched, the value is increased or decreased by one increment.

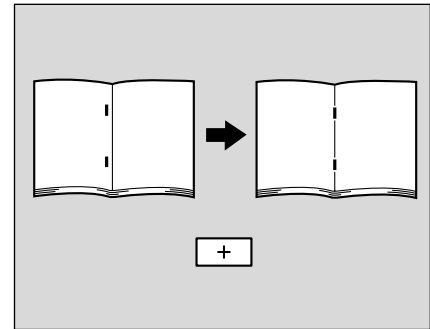

- If the staple position is too far to the right of the center of the paper, touch [-] to reduce the adjustment (between -0.1 mm and -12.8 mm).

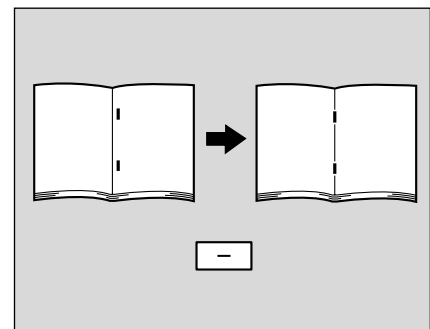

- 8** Touch [OK].
- To cancel the setting and select the default, press the [Reset] key.
The stapling position is adjusted.
If the stapling position was at the center of the paper in step 7, this completes the procedure.
- 9** Use the "Center Staple & Fold" setting to print another sample copy.
- 10** Check the print result.
- Check that the stapling position is adjusted to the center of the paper.
 - If more adjustment is necessary, repeat steps 6 through 9.

**Note**

Set the value by mm. Refer to the conversion rate below.
1 inch = 25.4 mm

11.6.2 Half-Fold Position

The folding position when printing with the "Half-Fold" setting can be adjusted for each paper size and for each paper type.

**Note**

[Half-Fold Position] does not appear if optional Finisher FS-610 is not installed.

If the angle of the center folding position must be adjusted, contact your service representative.



Detail

For details on the "Center Staple & Fold" setting, refer to *"Binding copies at the center ("Center Staple & Fold" setting)" on page 2-67.*

- ✓ Before making any adjustments, use the "Half-Fold" setting to print a single sample copy. Perform the adjustment while checking the sample that was created.
- 1 Display the Administrator Settings screen.
 - For details on displaying the Administrator Settings screen, refer to *"Displaying the Administrator Settings screen" on page 11-36.*
 - 2 Touch [1 System Settings].
The System Settings screen appears.
 - 3 Touch [7 Expert Adjustment].
The Expert Adjustment screen appears.
 - 4 Touch [5 Finisher Adjustment].
The Finisher Adjustment screen appears.
 - 5 Touch [2 Half-Fold Position].
The Half-Fold Position screen appears.

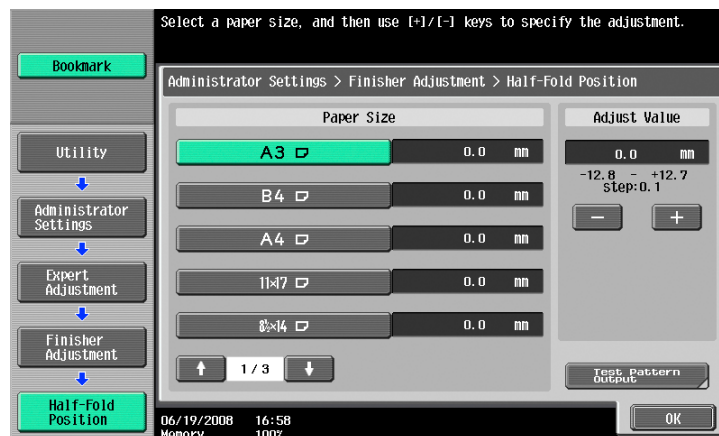

- 6 Touch the button for the paper size to be adjusted.
 - If the paper size to be adjusted is not displayed, touch [↑] and [↓] until the desired paper size is displayed.
- 7 Compare the width of the left pages of the copy sample with the width of the right pages to check for the center of the paper.
 - If the folding position is too far to the left of the center of the paper, touch [+] to increase the adjustment (between 0.1 mm and 12.7 mm).
 - Each time [+] or [-] is touched, the value is increased or decreased by one increment.

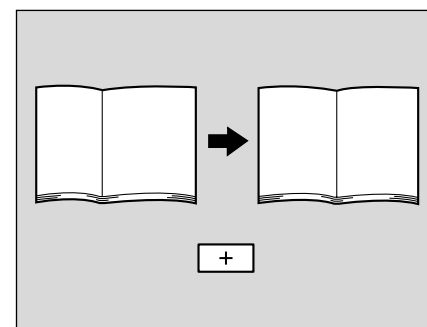

- If the folding position is too far to the right of the center of the paper, touch [-] to reduce the adjustment (between -0.1 mm and -12.8 mm).

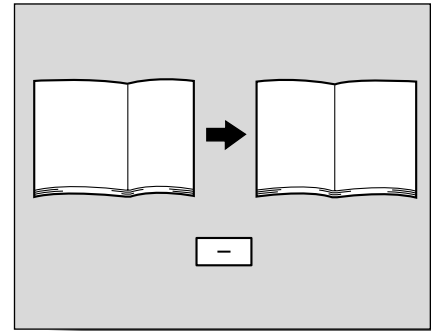

- 8 Touch [OK].
 - To cancel the setting and select the default, press the [Reset] key. The center folding position is adjusted. If the folding position was at the center of the paper in step 7, this completes the procedure.
- 9 Use the "Half-Fold" setting to print another sample copy.
- 10 Check the print result.
 - Check that the folding position is adjusted to the center of the paper.
 - If more adjustment is necessary, repeat steps 6 through 9.



...

Note

Set the value by mm. Refer to the conversion rate below.
1 inch = 25.4 mm

11.6.3 Punch Vertical Position Adjustment

The vertical position of punched holes when printing with a Punch setting can be adjusted for each paper size.



...

Note

[Punch Vertical Position Adjustment] appears only if optional punch kit is installed on the finisher.

For details on the Punch settings, refer to "[Punching holes in copies \(Punch settings\)](#)" on page 2-62.

- ✓ Before making any adjustments, use a Punch setting to print a sample copy. Perform the adjustment while checking the sample that was created.
- 1 Display the Administrator Settings screen.
 - For details on displaying the Administrator Settings screen, refer to "[Displaying the Administrator Settings screen](#)" on page 11-36.
 - 2 Touch [1 System Settings].
The System Settings screen appears.
 - 3 Touch [7 Expert Adjustment].
The Expert Adjustment screen appears.
 - 4 Touch [5 Finisher Adjustment].
The Finisher Adjustment screen appears.
 - 5 Touch [3 Punch Vertical Position Adjustment].

The Punch Vertical Position screen appears.

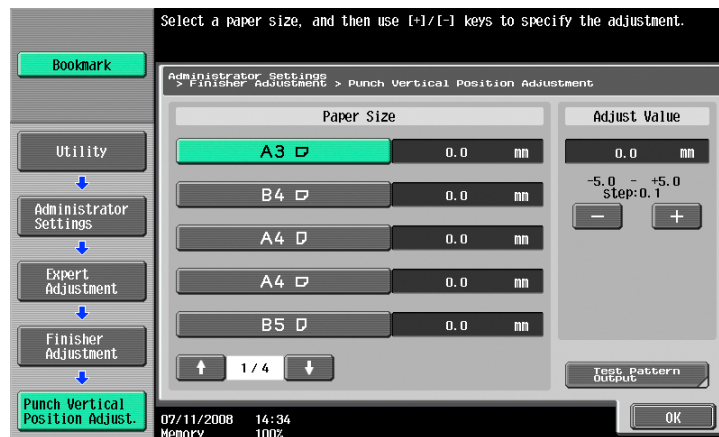

- 6 Touch the button for the paper size to be adjusted.
 - If the paper size to be adjusted is not displayed, touch [↑] and [↓] until the desired paper size is displayed.
- 7 Check the sample copy for the punch positions and for the center of the paper.
 - If the punch positions are too far above the center of the paper, touch [+] under "Adjust Value" to increase the adjustment (between 0.1 mm and 5.0 mm).
 - Each time [+] or [-] is touched, the value is increased or decreased by one increment.

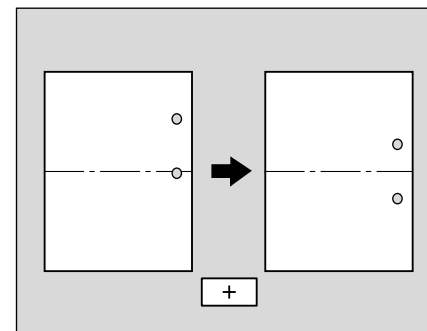

- If the punch positions are too far below the center of the paper, touch [-] under "Adjust Value" to increase the adjustment (between -0.1 mm and -5.0 mm).

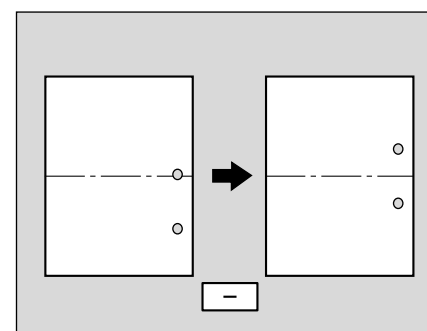

- 8 Touch [OK].
 - To cancel the setting and select the default, press the [Reset] key.

The vertical position of the punched holes is adjusted.
If no adjustment of the vertical position of the punched holes was necessary in step 7, this completes the procedure.
- 9 Use a Punch setting to print another sample copy.
- 10 Check the print result.

- Check that the vertical position of the punched holes was adjusted.
- If more adjustment is necessary, repeat steps 6 through 9.

**Note**

Set the value by mm. Refer to the conversion rate below.
1 inch = 25.4 mm

11.6.4 Punch Unit Vertical Position Adjustment

The vertical position of punched holes when printing with a Punch setting can be adjusted for each paper size.

**Note**

[Punch Unit Vertical Position Adjustment] appears only if optional Z folding unit is installed.

For details on the Punch settings, refer to "[Punching holes in copies \(Punch settings\)](#)" on page 2-62.

- ✓ Before making any adjustments, use a Punch setting to print a sample copy. Perform the adjustment while checking the sample that was created.

- 1 Display the Administrator Settings screen.
 - For details on displaying the Administrator Settings screen, refer to "[Displaying the Administrator Settings screen](#)" on page 11-36.
- 2 Touch [1 System Settings].
The System Settings screen appears.
- 3 Touch [7 Expert Adjustment].
The Expert Adjustment screen appears.
- 4 Touch [5 Finisher Adjustment].
The Finisher Adjustment screen appears.
- 5 Touch [4 Punch Unit Vertical Position Adjustment].
The Punch Unit Vertical Position screen appears.

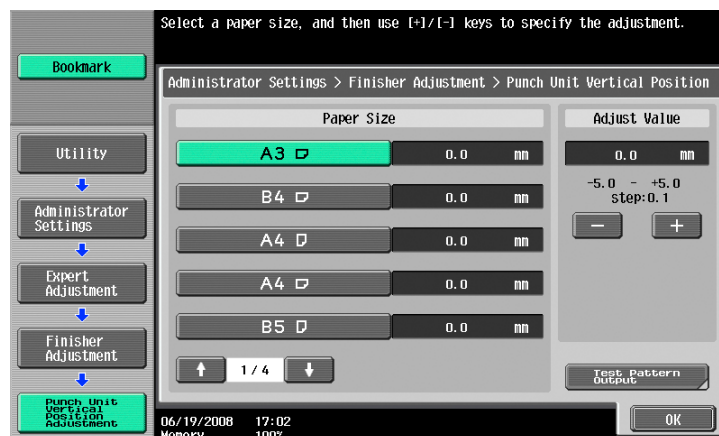

- 6 Touch the button for the paper size to be adjusted.
 - If the paper size to be adjusted is not displayed, touch [↑] and [↓] until the desired paper size is displayed.
- 7 Check the sample copy for the punch positions and for the center of the paper.
 - If the punch positions are too far above the center of the paper, touch [+] under "Adjust Value" to increase the adjustment (between 0.1 mm and 5.0 mm).

- Each time [+] or [-] is touched, the value is increased or decreased by one increment.

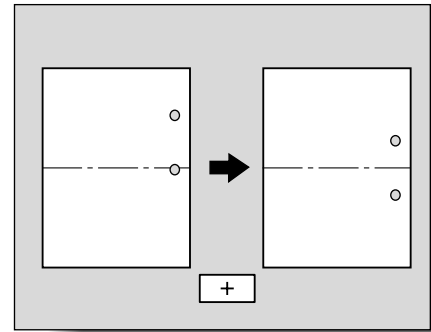

- If the punch positions are too far below the center of the paper, touch [-] under "Adjust Value" to increase the adjustment (between -0.1 mm and -5.0 mm).

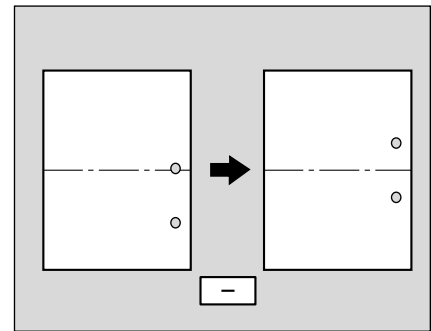

- 8 Touch [OK].
 - To cancel the setting and select the default, press the [Reset] key.
 The vertical position of the punched holes is adjusted.
 If no adjustment of the vertical position of the punched holes was necessary in step 7, this completes the procedure.
- 9 Use a Punch setting to print another sample copy.
- 10 Check the print result.
 - Check that the vertical position of the punched holes was adjusted.
 - If more adjustment is necessary, repeat steps 6 through 9.



...

Note

Set the value by mm. Refer to the conversion rate below.
 1 inch = 25.4 mm

11.6.5 Punch Horizontal Position Adjustment

The horizontal position of punched holes when printing with a Punch setting can be adjusted for each paper size.



...

Note

[Punch Horizontal Position Adjustment] appears only if optional punch kit is installed on the finisher.

For details on the Punch settings, refer to "[Punching holes in copies \(Punch settings\)](#)" on page 2-62.

- ✓ Before making any adjustments, use a Punch setting to print a sample copy. Perform the adjustment while checking the sample that was created.
- 1 Display the Administrator Settings screen.
 - For details on displaying the Administrator Settings screen, refer to "[Displaying the Administrator Settings screen](#)" on page 11-36.
 - 2 Touch [1 System Settings].

The System Settings screen appears.

- 3 Touch [7 Expert Adjustment].

The Expert Adjustment screen appears.

- 4 Touch [5 Finisher Adjustment].

The Finisher Adjustment screen appears.

- 5 Touch [5 Punch Horizontal Position Adjustment].

The Punch Horizontal Position Adjustment screen appears.

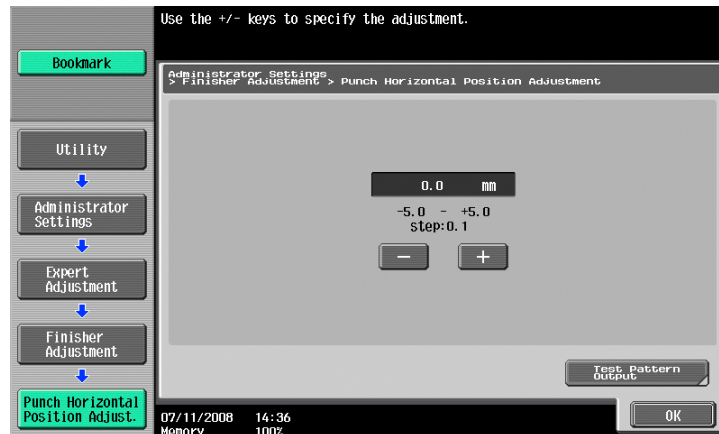

- 6 Check the horizontal position of the punched holes.

- To increase width A, touch [+] to increase the adjustment (between 0.1 mm and 5.0 mm).
- Each time [+] or [-] is touched, the value is increased or decreased by one increment.

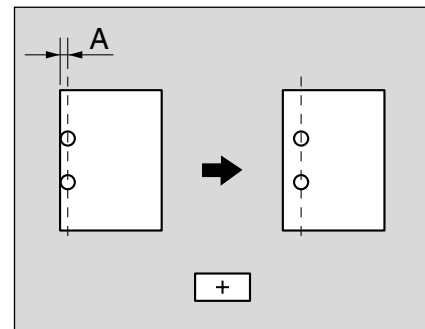

- To decrease width A, touch [-] to decrease the adjustment (between -0.1 mm and -5.0 mm).

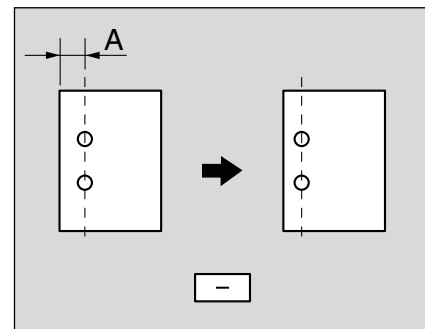

- 7 Touch [OK].

- To cancel the setting and select the default, press the [Reset] key.

The horizontal position of the punched holes is adjusted.

If no adjustment of the horizontal position of the punched holes was necessary in step 6, this completes the procedure.

- 8 Use a Punch setting to print another sample copy.
- 9 Check the print result.
 - Check that the horizontal position of the punched holes was adjusted.
 - If more adjustment is necessary, repeat steps 6 through 9.

**Note**

Set the value by mm. Refer to the conversion rate below.
1 inch = 25.4 mm

11.6.6 Punch Unit Horizontal Position Adjustment

The horizontal position of punched holes when printing with a Punch setting can be adjusted.

**Note**

[Punch Unit Horizontal Position Adjustment] appears only if optical Z folding unit is installed.

For details on the Punch settings, refer to "[Punching holes in copies \(Punch settings\)](#)" on page 2-62.

- ✓ Before making any adjustments, use a Punch setting to print a sample copy. Perform the adjustment while checking the sample that was created.
- 1 Display the Administrator Settings screen.
 - For details on displaying the Administrator Settings screen, refer to "[Displaying the Administrator Settings screen](#)" on page 11-36.
 - 2 Touch [1 System Settings].
The System Settings screen appears.
 - 3 Touch [7 Expert Adjustment].
The Expert Adjustment screen appears.
 - 4 Touch [5 Finisher Adjustment].
The Finisher Adjustment screen appears.
 - 5 Touch [6 Punch Unit Horizontal Position Adjustment].
The Punch Unit Horizontal Position Adjustment screen appears.



- 6 Check the horizontal position of the punched holes.
 - To increase width A, touch [+] to increase the adjustment (between 0.1 mm and 5.0 mm).

- Each time [+] or [-] is touched, the value is increased or decreased by one increment.

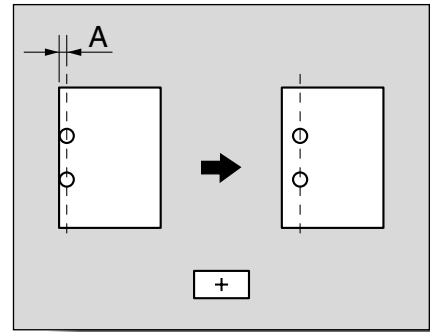

- To decrease width A, touch [-] to decrease the adjustment (between -0.1 mm and -5.0 mm).

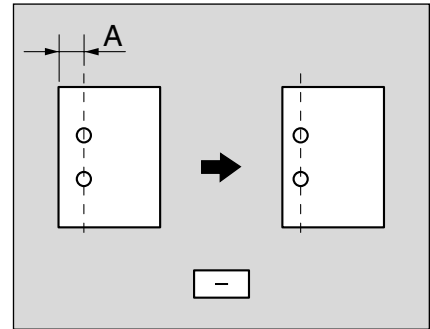

- 7 Touch [OK].
 - To cancel the setting and select the default, press the [Reset] key.
 The horizontal position of the punched holes is adjusted.
 If no adjustment of the horizontal position of the punched holes was necessary in step 6, this completes the procedure.
- 8 Use a Punch setting to print another sample copy.
- 9 Check the print result.
 - Check that the horizontal position of the punched holes was adjusted.
 - If more adjustment is necessary, repeat steps 6 through 9.



...

Note

Set the value by mm. Refer to the conversion rate below.
 1 inch = 25.4 mm

11.6.7 Punch Resist Loop Size Adjustment

When printing with a Punch setting, the angle of punched holes along the side of the paper can be adjusted.



...

Note

[Punch Resist Loop Size Adjustment] appears only if optional punch kit is installed on the finisher.

For details on the Punch settings, refer to "[Punching holes in copies \(Punch settings\)](#)" on page 2-62.

- ✓ Before making any adjustments, use a Punch setting to print a sample copy. Perform the adjustment while checking the sample that was created.
- 1 Display the Administrator Settings screen.
 - For details on displaying the Administrator Setting screen, refer to "[Displaying the Administrator Settings screen](#)" on page 11-36.
 - 2 Touch [1 System Settings].
 The System Settings screen appears.

- 3 Touch [7 Expert Adjustment].
The Expert Adjustment screen appears.
- 4 Touch [5 Finisher Adjustment].
The Finisher Adjustment screen appears.
- 5 Touch [7 Punch Resist Loop Size Adjustment].
The Punch Resist Loop Size Adjustment screen appears.

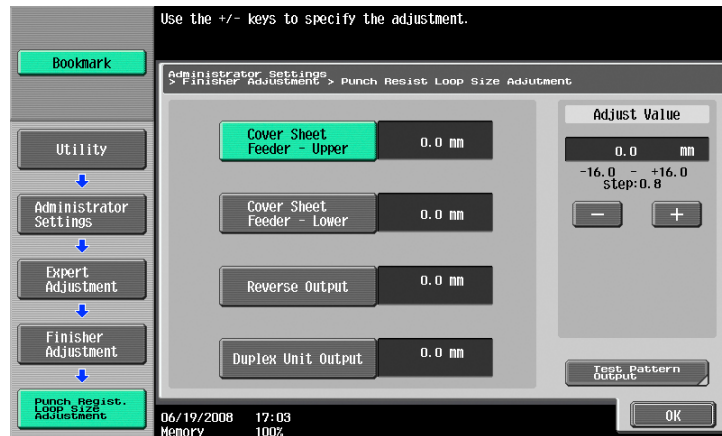

- 6 Touch the button for the desired adjustment parameter.
- 7 Check the angle of the punched holes.
 - If the punched holes are angled, touch [+] to change the adjustment. If the angle cannot be adjusted by touching [+] or if the paper is wrinkled, touch [-] to change the adjustment.
 - Each time [+] or [-] is touched, the value is increased or decreased by one increment.
- 8 Touch [OK].
 - To cancel the setting and select the default, press the [Reset] key.

The angle of the punched holes is adjusted.
If no adjustment of the angle of the punched holes was necessary in step 6, this completes the procedure.
- 9 Use a Punch setting to print another sample copy.
- 10 Check the print result.
 - Check that the angle of the punched holes was adjusted.
 - If more adjustment is necessary, repeat steps 7 through 10.

**Note**

Set the value by mm. Refer to the conversion rate below.
1 inch = 25.4 mm

11.6.8 1st Z-Fold Position Adjustment/2nd Z-Fold Position Adjustment

The first and second folding position when printing with the "Z-Fold" setting can be adjusted for each paper size.

**Note**

[1st Z-Fold Position Adjustment] and [2nd Z-Fold Position Adjustment] do not appear if optional Z folding unit is not installed.

- ✓ Before making any adjustments, use the "Z-Fold" setting to print a single sample copy. Perform the adjustment while checking the sample that was created. In addition, to adjust both the 1st and 2nd folding positions for Z-folding, be sure to adjust the 1st folding position first.

- 1 Display the Administrator Settings screen.
 - For details on displaying the Administrator Settings screen, refer to **"Displaying the Administrator Settings screen" on page 11-36.**
- 2 Touch [1 System Settings].
The System Settings screen appears.
- 3 Touch [7 Expert Adjustment].
The Expert Adjustment screen appears.
- 4 Touch [5 Finisher Adjustment].
The Finisher Adjustment screen appears.
- 5 Touch [8 1st Z-Fold Position Adjustment] or [9 2nd Z-Fold Position Adjustment].
The Z-Fold Position Adjustment screen appears.

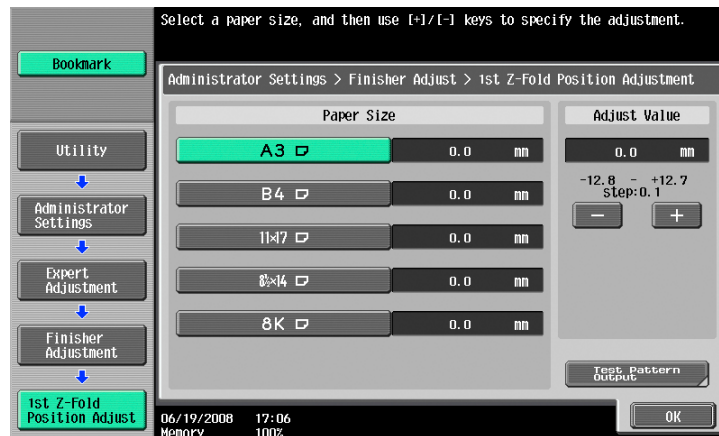

- 6 Touch the button for the paper size to be adjusted.
- 7 Check the folding positions in the sample copy.
 - If the folding position is too far on the left side of the paper, touch [+] under "Adjust Value" to increase the adjustment (between 0.1 mm and 12.7 mm).
 - Each time [+] or [-] is touched, the value is increased or decreased by one increment.

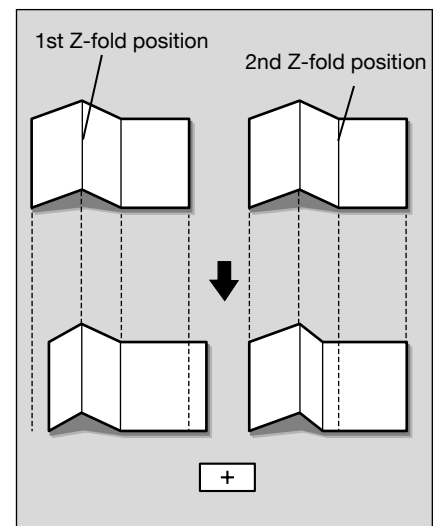

If the folding position is too far on the right side of the paper, touch [-] under "Adjust Value" to increase the adjustment (between -0.1 mm and -12.8 mm).

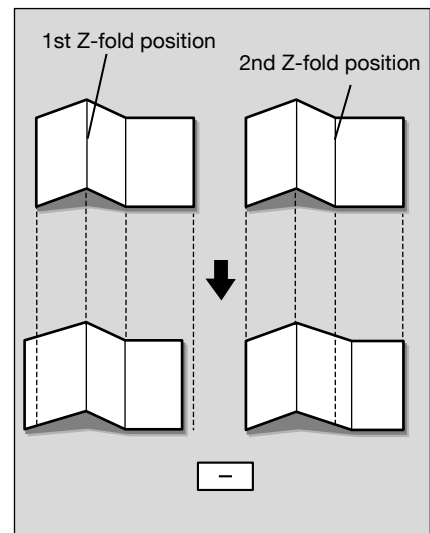

Adjust values so that the distance between the left edge of the paper and the 2nd Z-folding position is 2 mm or more.

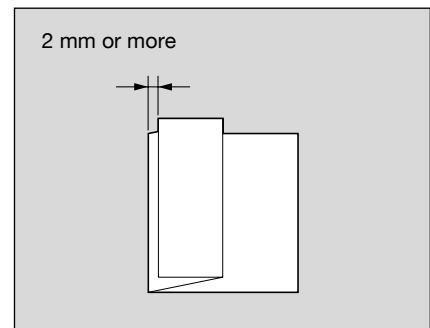

- 8 Touch [OK].
 - To cancel the setting and select the default, press the [Reset] key. The folding positions are adjusted. If no adjustment of the folding positions were necessary in step 7, this completes the procedure.
- 9 Use the "Z-Fold" setting to print another sample copy.
- 10 Check the print result.
 - Check that the folding positions were adjusted.
 - If more adjustment is necessary, repeat steps 6 through 10.



Note

Set the value by mm. Refer to the conversion rate below.
1 inch = 25.4 mm

11.6.9 Tri-Fold Position Adjustment

The folding position when printing with the "Tri-Fold" setting can be adjusted for each paper size.



Note

[Tri-Fold Position Adjustment] does not appear if optional Finisher FS-610 is not installed.

- ✓ Before making any adjustments, use the "Tri-Fold" setting to print a single sample copy. Perform the adjustment while checking the sample that was created.

- 1 Display the Administrator Settings screen.
 - For details on displaying the Administrator Settings screen, refer to ["Displaying the Administrator Settings screen" on page 11-36](#).
- 2 Touch [1 System Settings].
The System Settings screen appears.
- 3 Touch [7 Expert Adjustment].
The Expert Adjustment screen appears.
- 4 Touch [5 Finisher Adjustment].
The Finisher Adjustment screen appears.
- 5 Touch [10 Tri-Fold Position Adjustment].
The Tri-Fold Position Adjustment screen appears.

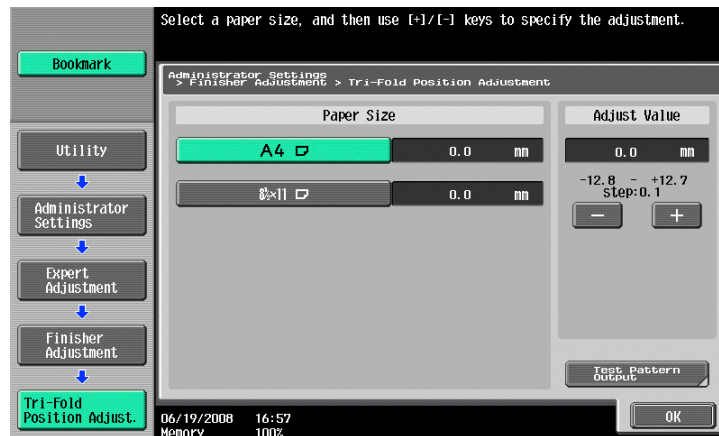

- 6 Touch the button for the paper size to be adjusted.
- 7 Check the folding positions in the sample copy.
 - If the folding position is too far on the right side of the paper, touch [+] under "Adjust Value" to increase the adjustment (between 0.1 mm and 12.7 mm).
 - Each time [+] or [-] is touched, the value is increased or decreased by one increment.

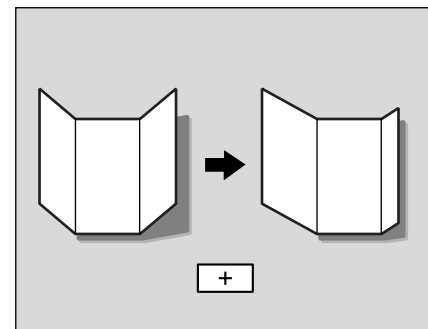

- If the folding position is too far on the left side of the paper, touch [-] under "Adjust Value" to increase the adjustment (between -0.1 mm and -12.8 mm).

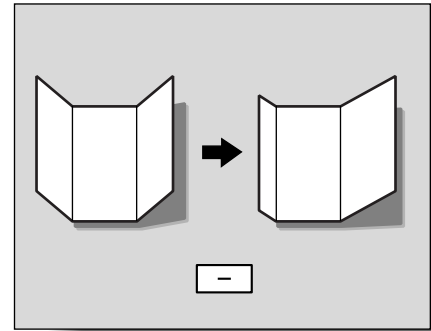

- 8 Touch [OK].
 - To cancel the setting and select the default, press the [Reset] key.
 The folding positions are adjusted.
 If no adjustment of the folding positions were necessary in step 7, this completes the procedure.
- 9 Use the "Tri-Fold" setting to print another sample copy.
- 10 Check the print result.
 - Check that the folding positions were adjusted.
 - If more adjustment is necessary, repeat steps 6 through 10.



...

Note

Set the value by mm. Refer to the conversion rate below.
 1 inch = 25.4 mm

11.6.10 2-Position Staple Pitch Adjustment

The distance between staples when printing with the "2 Position" Staple setting ("Staple" and "Center Staple & Fold") can be adjusted.



...

Note

[2-Position Staple Pitch Adjustment] does not appear if optional Finisher FS-610 is not installed.

- ✓ Before making any adjustments, use the "2 Position" Staple setting to print a sample copy. Perform the adjustment while checking the sample that was created.
- 1 Display the Administrator Settings screen.
 - For details on displaying the Administrator Settings screen, refer to "[Displaying the Administrator Settings screen](#)" on page 11-36.
 - 2 Touch [1 System Settings].
 The System Settings screen appears.
 - 3 Touch [7 Expert Adjustment].
 The Expert Adjustment screen appears.
 - 4 Touch [5 Finisher Adjustment].
 The Finisher Adjustment screen appears.
 - 5 Touch [Forward →], and then touch [1 2-Position Staple Pitch Adjustment].

The Adjust Spacing of 2 Staples screen appears.



- 6 Touch the button for the setting to be adjusted.
- 7 Check the stapling positions in the sample copy.
 - Touch [+] or [-] under "Adjust Value" to adjust the distance (between 128 mm and 160 mm) between the staples.
 - Each time [+] or [-] is touched, the value is increased or decreased by one increment.
- 8 Touch [OK].
The distance between the staples is adjusted.
If no adjustment of the distance between the staples was necessary in step 7, this completes the procedure.
- 9 Use the "2 Position" Staple setting to print another sample copy.
- 10 Check the print result.
 - Check that the distance between the staples was adjusted.
 - If more adjustment is necessary, repeat steps 6 through 10.



Note

Set the value by mm. Refer to the conversion rate below.
1 inch = 25.4 mm

11.6.11 Post Inserter Tray Size Adjustment

The sensors for detecting the size of paper loaded in the paper trays of the optional post inserter can be adjusted.



Note

[Post Inserter Tray Size Adjustment] appears only if optional post inserter is installed.

- 1 Display the Administrator Setting screen.
 - For details on displaying the Administrator Settings screen, refer to "[Displaying the Administrator Settings screen](#)" on page 11-36.
- 2 Touch [1 System Settings].
The System Settings screen appears.
- 3 Touch [7 Expert Adjustment].
The Expert Adjustment screen appears.
- 4 Touch [5 Finisher Adjustment].
The Finisher Adjustment screen appears.

- 5 Touch [Forward→], and then touch [2 Post Inserter Tray Size Adjustment].
The Post Inserter Tray Size Adj. screen appears.



- 6 Load the selected paper in the paper tray for the post inserter, and then press the [Start] key.
- 7 Touch [Close].

11.7 Header/Footer Settings

Follow the procedures described below to specify headers/footers used with the Stamp/Composition functions available from the Application tab.

11.7.1 Specifying headers/footers

- 1 Display the Administrator Settings screen.
 - For details on displaying the Administrator Settings screen, refer to "[Displaying the Administrator Settings screen](#)" on page 11-36.
- 2 Touch [1 System Settings].
The System Settings screen appears.
- 3 Touch [Forward→], and then touch [2 Stamp Settings].
The Stamp Settings screen appears.
- 4 Touch [1 Header/Footer Settings].



The Header/Footer Settings screen appears.

- 5 Touch [New].

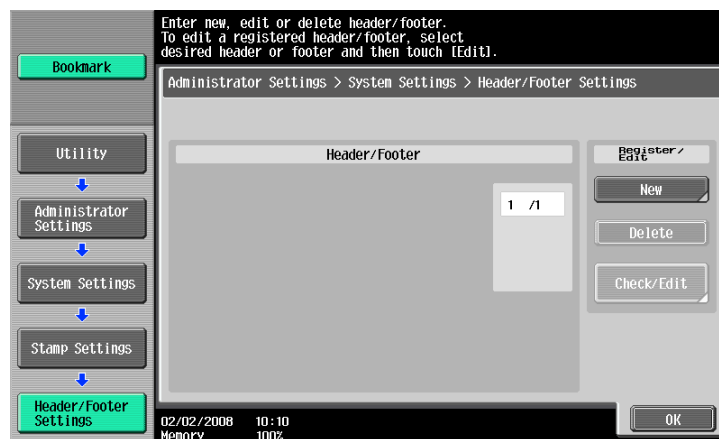

The Header/Footer Settings > New screen appears.

- 6 Touch [Name].



The New > Name screen appears.

- 7 Type in the header/footer name (up to 16 characters long), and then touch [OK].
- For details on typing in text, refer to ["Entering text" on page 14-2](#).



The header/footer name is specified.

- 8 Under "Header Settings" or "Footer Settings", touch [Print], and then select the type of header/footer to be printed.

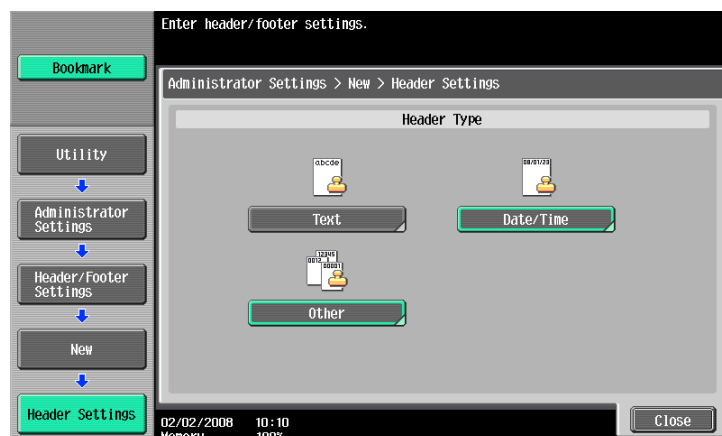

Touch [Close].

- 9 Select the desired setting under "Pages", and specify the desired settings for "Text Size" and "Print Position".
- 10 Touch [OK].

**Detail**

To print the header/footer only on the first page, touch [1st Page Only].

11.7.2 Editing headers/footers

- 1 In the Header/Footer Settings screen, touch the button of the header/footer to be edited.
- 2 Touch [Check/Edit].

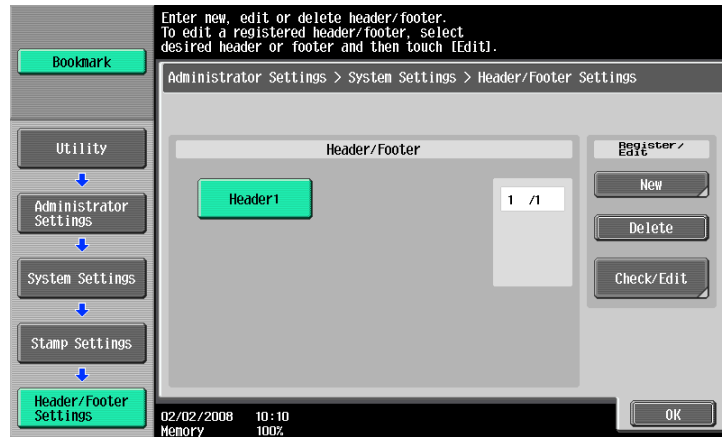

- To delete the header/footer, touch [Delete].
The Check/Edit screen appears.

- 3 Touch [OK].

11.8 Authentication Method

Specify user authentication and account track settings in order to control the use of this machine.

User authentication settings are specified to manage individuals, and account track settings are specified to manage groups and multiple users.

By specifying both user authentication and account track settings, the number of prints made by each account can be managed for each individual user.



Note

A total of 1,000 users and accounts can be registered on this machine.

If an authentication mode is set, the authentication screen is displayed while this machine is in standby. In order to use this machine when user authentication or account track settings are specified, the user name and password must be entered. For details, refer to "[Controlling each user's use of this machine \(User Authentication\)](#)" on page 1-35.

User authentication and account track can be specified without synchronizing.

11.8.1 User authentication and account track

User authentication and account track can be used to specify the following settings.

- User Authentication
 - Limits on the available functions (copy operations, scanning operations, fax operations, printing, document storing operations, transmitted document printing and saving document to the external memory)
 - Counters for printing/scanning by each user
 - Management of group user boxes and personal user boxes for each owner
 - Management of the level and the group with permissions to access destinations by each owner
 - Delete jobs of other users
- Account Track
 - Counters for printing/scanning from each account
 - Operates the group box

11.8.2 When user authentication and account track are synchronized

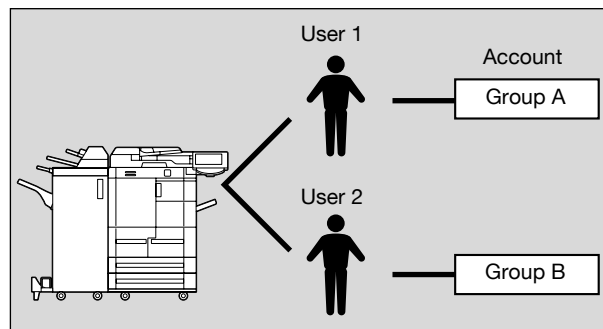

This setup is used when the machine is used by multiple departments and the use by each employee is managed by each department. With this setup, statistics can be maintained on each employee (each user) and on each department (each account).

To manage the use of this machine in this way, specify the following authentication settings.

Parameter on Authentication Method screen	Settings
User Authentication	Select "ON (External Server)" or "ON (MFP)".
Account Track	Select "ON", and then specify the account name and password.
Synchronize User Authentication & Account Track	Select "Synchronize".
Account Name (on User Registration screen)	Select an account name if "ON (MFP)" was selected.

**Note**

For details on external server authentication, refer to the *User's Guide [Network Administrator]*.

11.8.3 When user authentication and account track are used separately

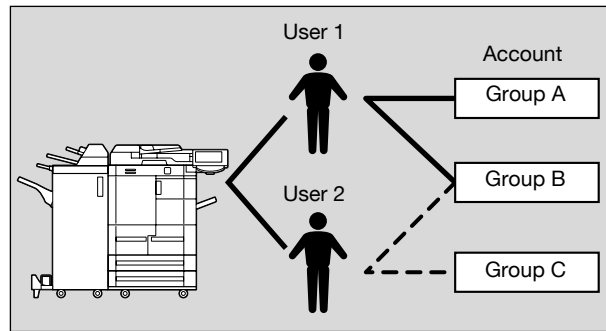

This setup is used when the machine is used by multiple employees with each employee performing multiple duties, which are to be totaled separately. With this setup, statistics can be maintained for each employee (each user) and on each duty of the employee (each account). In addition, totals can be maintained on each employee (each user) and each duty (each account) even if the same duty is performed by two different employees.

To manage the use of this machine in this way, specify the following authentication settings.

Parameter on Authentication Method screen	Settings
User Authentication	Select "ON (External Server)" or "ON (MFP)".
Account Track	Select "ON", and then specify the account name and password.
Synchronize User Authentication & Account Track	Select "Do Not Synchronize".

11.8.4 Selecting an authentication method

- 1 Display the Administrator Settings screen.
 - For details on displaying the Administrator Settings screen, refer to "[Displaying the Administrator Settings screen](#)" on page 11-36.
- 2 Touch [4 User Authentication/Account Track].
The User Authentication/Account Track screen appears.
- 3 Touch [1 General Settings].
The General Settings screen appears.
- 4 Specify a setting for "User Authentication".
 - To cancel user authentication, touch [OFF].
 - To use an external server to perform user authentication, touch [External Server Authentication], and then select the server type.
 - In order to use an external server, the external server must first be registered.

- To use this machine's authentication system to perform user authentication, touch [ON (MFP)].



- 5 Specify a setting for "Public User Access".
 - To prohibit unregistered users from using this machine, touch [Restrict].
 - To allow this machine to be used by touching [Public User Access] in the authentication screen without entering a user name or password even though user authentication settings have been applied, touch [Allow].
 - "ON (Without Login)" allows the machine to be used without authentication when logging on as a public user. When logging on as an authorized user, the [Access] key must be pressed first to display the authentication screen.
- 6 Specify a setting for "Account Track".
 - To cancel account tracking, touch [OFF].
 - To use the account track function, touch [ON].
- 7 Specify a setting for "Account Track Input Method".
 - To allow this machine to be used after the account name and password are entered in the account track screen, touch [Account Name & Password].
 - To allow this machine to be used after the password is entered in the account track screen, touch [Password Only].
- 8 Specify a setting for "Synchronize User Authentication & Account Track".
 - Synchronize
 "ON (MFP)" is set and "Account Track" is set to "ON", this setting allows this machine to be used simply by entering user authentication information the first time that the machine is used if the corresponding account was specified during user registration.
 When "External Server Authentication" is selected and "Account Track" is "ON", and once the machine is used with the appropriate user authentication and account track information entered, this setting allows the machine to be used simply by entering user authentication information by being synchronized with the authenticated account.
 - Do Not Synchronize
 This setting requires that all information be entered for user authentication and account track each time that the machine is used.
- 9 Touch [↓].
 The second screen is displayed.
- 10 Specify a setting for "When # of Jobs Reach Maximum".
 - To skip the job when the limit specified with user authentication or account track is reached, touch [Skip Job].

- To stop all jobs when the limit specified with user authentication or account track is reached, touch [Stop Job].

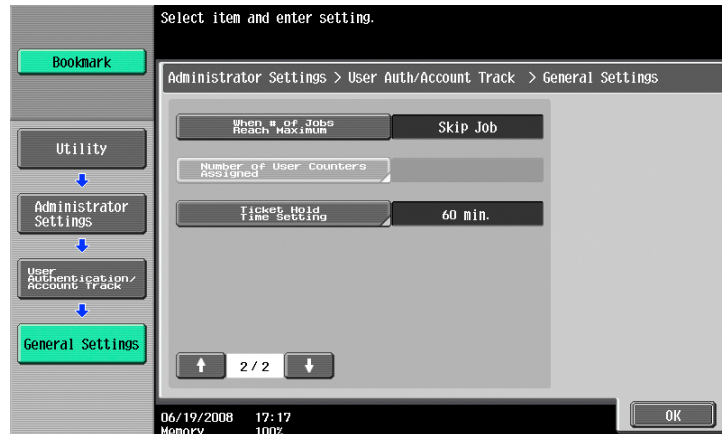

11 Specify a setting for "Number of User Counters Assigned".

- Press the [C] (clear) key to erase the value, and then use the keypad to specify the desired value (between 1 and 999).
- If user authentication and account track settings have been applied, counters can be assigned to both accounts and users, and counts for both can be totaled.

12 Specify "Ticket Hold Time Setting".

- Use the keypad to type in the time. (1 to 60 minutes)
- Specify the holding time of Kerberos authentication ticket. The holding time setting is applied when Active Directory is selected as the authentication server type.

13 Touch [OK].

- If the setting for "User Authentication", "Account Track" or "Number of User Counters Assigned" was changed, the message "Are you sure you want to clear all data?" appears.

14 Touch [Yes], and then touch [OK].

- To stop clearing the usage data without changing the settings, touch [No].
- If the setting for any of the following is changed, the data is not cleared. "Public User Access", "When # of Jobs Reach Maximum", "Synchronize User Authentication & Account Track" or "Ticket Hold Time Setting"
- To cancel the setting and select the default, press the [Reset] key.

The authentication method is set.

Continue by specifying settings for user authentication and account track.



Reminder

Do not use a name including uppercase and lowercase of the same character for the user name of the external server. Since bizhub 751/601 cannot differentiate between uppercase and lowercase letters, the operation may not be performed correctly.



Note

"Synchronize User Authentication & Account Track" can be specified if "User Authentication" is set to "ON (External Server)" or "ON (MFP)" and "Account Track" is set to "ON".

If "Synchronize User Authentication & Account Track" is set to "Synchronize", even when "Public User Access" is set to "Allow", "Public User Access" changes to "Restrict".

"Number of User Counters Assigned for Users" can be specified if "User Authentication" is set to "ON (External Server)" or "ON (MFP)" and "Account Track" is set to "ON".

If the number of user counters is set to "50", up to 950 accounts can be registered.

**Detail**

For details on external server authentication, refer to the User's Guide [Network Administrator].

If "Synchronize User Authentication & Account Track" was set to "Do Not Synchronize", use by a public user is not permitted.

If both user authentication and account track settings have been applied, "Account Name & Password" is selected.

A public user can be set to provide temporary access to this machine. If public user access is permitted, it is recommended that limitations be placed on the machine functions that can be used. For details, refer to ["User Registration" on page 11-66](#).

If account track settings have been applied while "User Authentication" is set to "ON (MFP)" or "ON (External Server)", type in the user name and password in the user authentication screen, and then type in the account name and password in the account track screen.

When "ON (MFP)" is selected and "Account Track" is "ON", and once the machine is used with the appropriate user authentication and account track information entered, the authenticated account is registered to the account name. The machine can be used simply by entering user authentication information from the next time.

11.9 User Authentication Setting

User authentication settings can be specified.

11.9.1 Administrative Settings—List

User authentication settings can be specified to display [List] in the user authentication screen and the User Name screen. Touch [List] to display a list of registered user names from which the desired user name can simply be selected. (The default setting is "OFF".)

- 1 Display the Administrator Settings screen.
 - For details on displaying the Administrator Settings screen, refer to "[Displaying the Administrator Settings screen](#)" on page 11-36.
- 2 Touch [4 User Authentication/Account Track].
The User Authentication/Account Track screen appears.
- 3 Touch [2 User Authentication Settings].
The User Authentication Setting screen appears.
 - ? Why is [2 User Authentication Settings] not available?
→ [2 User Authentication Settings] is not available if "User Authentication" on the General Settings screen is set to "OFF".
- 4 Touch [1 Administrative Settings].

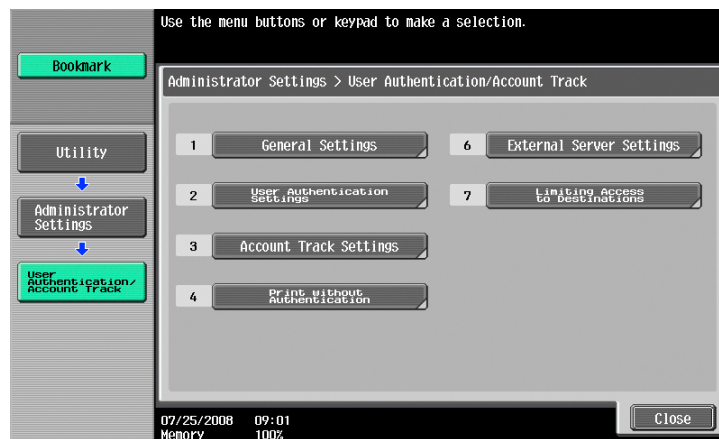

- 5 Touch [User Name List].
Buttons for the available settings appear.
- 6 Touch the button for the desired setting.
Whether or not a user name list button appears is set.

11.9.2 Default Function Permission

If external server authentication was selected, limitations can be placed on the machine functions that can be used by an authorized user. (The default setting is "Allow".)

The following operations can be limited.

- Copy operations
- Scan operations
- Fax operations
- Printing from a printer
- Saving documents on the hard disk
- Printing the transmitted document
- Saving the document to the external memory



Note

To limit machine use by registered users, specify settings in the User Registration screen.

With "Print Scan/Fax TX", printing can be prevented when scanning or faxing a document saved in a box.

- 1 Display the Administrator Settings screen.
 - For details on displaying the Administrator Settings screen, refer to "[Displaying the Administrator Settings screen](#)" on page 11-36.
- 2 Touch [4 User Authentication/Account Track].
The User Authentication/Account Track screen appears.
- 3 Touch [2 User Authentication Settings].
The User Authentication Setting screen appears.
 - ? Why is [2 User Authentication Settings] not available?
→ [2 User Authentication Settings] is not available if "User Authentication" on the General Settings screen is set to "OFF".
- 4 Touch [1 Administrative Settings].
- 5 Touch [Default Function Permission].
The Function Permission screen appears.
- 6 Touch the button for the desired settings.

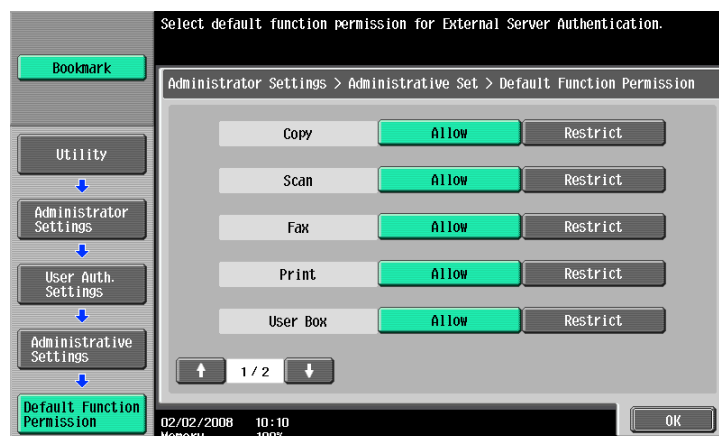

- 7 Touch [OK].
The default function permissions are set.

11.9.3 Public User Access

If user authentication settings have been specified and public user access is permitted, there are two methods for authenticating the public user.

Allow: Touch [Public User] in the authentication screen to display the Basic Screen and operate the machine.

ON (Without Login): The machine can be used without authentication when logging on as a public user. When logging on as an authorized user, the [Access] key must be pressed first to display the authentication screen. (The default setting is "Restrict".)

- 1 Display the Administrator Settings screen.
 - For details on displaying the Administrator Settings screen, refer to "[Displaying the Administrator Settings screen](#)" on page 11-36.
- 2 Touch [4 User Authentication/Account Track].
The User Authentication/Account Track screen appears.
- 3 Touch [1 General Settings].
- 4 Touch [Public User Access].
Buttons for the available settings appear.
- 5 Touch the button for the desired setting.
The public user authentication method is set.



Detail

[Public User Access] is not available if "User Authentication" is set to "OFF".

11.9.4 User Registration

The password, number of prints allowed, and function permissions can be specified for each user of this machine.

In addition, if an authentication unit is installed on this machine, the user's IC card or the vein patterns of their finger can be registered.

As an example, the following procedure describes how to register a user with authentication performed by the machine.

- ✓ A total of 1,000 users and accounts can be registered on this machine.
- ✓ If "Public User Access" on the General Settings screen is set to "Allow", a public user is added. Function limitations can be specified for the public user.
- ✓ If "Account Track" on the General Settings screen is set to "ON", the number of users set for "Number of User Counters Assigned" can be registered.

- 1 Display the Administrator Settings screen.
 - For details on displaying the Administrator Settings screen, refer to "[Displaying the Administrator Settings screen](#)" on page 11-36.
- 2 Touch [4 User Authentication/Account Track].
The User Authentication/Account Track screen appears.
- 3 Touch [2 User Authentication Settings].
The User Authentication Setting screen appears.
 - ? Why is [2 User Authentication Settings] not available?
 - [2 User Authentication Settings] is not available if "User Authentication" on the General Settings screen is set to "OFF".
- 4 Touch [2 User Registration].
- 5 Touch the button for the desired user, and then touch [Edit].
The Edit screen for the user appears.

6 Touch [User Name].



The User Name screen appears.

7 Type in the user name (up to 64 characters long), and then touch [OK].

- For details on typing in text, refer to ["Entering text" on page 14-2](#).
- Once a user name is registered, it cannot be changed.
- A user name that has already been registered cannot be used again.



The user name is set.

8 Touch [Password].

The Password screen appears.

? Why is [Password] not available?

→ [Password] is not available if "User Authentication" on the General Settings screen is set to "ON (External Server)".

9 Type in the password (up to 64 characters long), and then touch [OK].

For confirmation, the Password screen appears again. Retype the same password, and then touch [OK]. The user password is set.

10 Touch [E-Mail Address].

The E-Mail Address screen appears.

11 Type in the e-mail address (up to 320 characters), and then touch [OK].

The e-mail address is set.

If the e-mail address exceeds 69 characters, [Detail] appears in the User Registration screen. Touch [Details] to display the E-Mail Address Details screen and the entire e-mail address.

12 To use the account track function, touch [Account Name].

- [Account Name] appears only if "Account Track" on the General Settings screen been set to "ON". The Account Name screen appears.

- 13** Touch the button for the desired account, and then touch [OK].
- Before an account name can be selected, accounts must have been registered. For details on registering accounts, refer to "[Account Track Registration](#)" on page 11-72. The account is set.
- 14** Touch [Max. Allowance Set].
- The Max. Allowance Set screen appears.
- 15** To specify the maximum number of prints allowed, use the keypad to type in the desired value.
- To specify no maximum for prints, touch [No Limit].

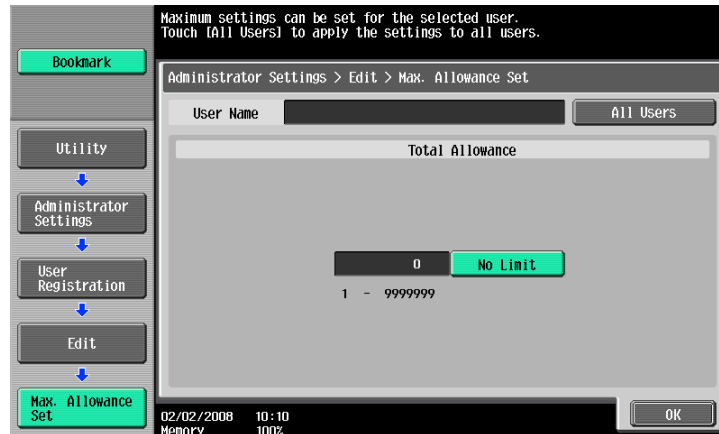

- 16** Touch [OK].
- The maximum number of prints allowed is set.
- 17** To use authentication unit (biometric type) or authentication unit (IC card type), touch [Register Auth. Info.].
- [Register Auth. Info.] appears only if an authentication unit is installed on this machine. The Register Auth. Info. screen appears.
- 18** Touch [Edit].
- When using authentication unit (biometric type), place a finger on the authentication unit and register the vein patterns.
 - When using authentication unit (IC card type), place an IC card on the authentication unit and register the card information.
- 19** Touch [Function Permission].
- The Function Permission screen appears.
- 20** Touch the button for the desired setting for each operation.
- To permit the operation to be performed, touch [Allow].

- To prohibit the operation to be performed, touch [Restrict].

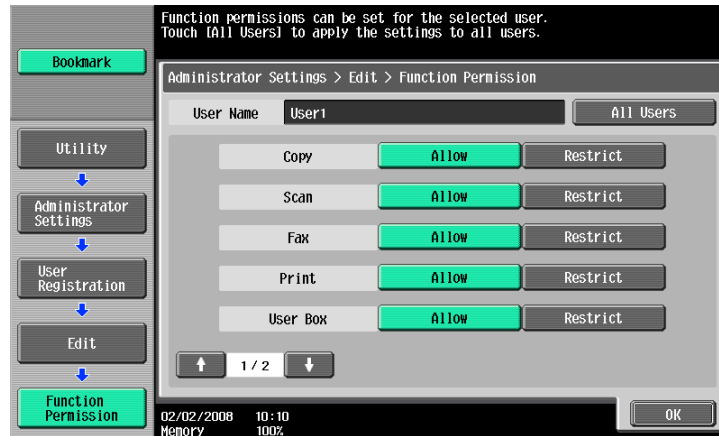

- Touch [All Users] to apply the settings in the current screen to all registered users. Touch [All Users], touch [OK], and then touch [OK] in the next screen that appears.
- With "Print Scan/Fax TX", printing can be prevented when scanning or faxing a document saved in a box.
- Depending on the function limitation settings that are specified, a different Basic screen may appear when logging on. The Basic screen that appears changes in the following order: Copy → Scan → Fax → Box.
- If no operation is permitted, user authentication cannot be performed.

21 Touch [OK].

The function permissions are set.

22 Touch [OK].

- To cancel the settings in the current screen, touch [Cancel].
- To delete the selected user information, touch [Delete] in the User Registration screen.

11.9.5 User Counter

The following data for each user can be checked.

Copy + Print

This table shows the total number of pages printed with copy and print operations.

- Total: Total number of printed pages
- Max Allowance: Limits specified during user registration for the number of pages
- Large Size: Total number of pages printed on large-sized paper

Copy

This table shows the total number of pages printed with copy operations.

- Total: Total number of copied pages
- Large Size: Total number of pages copied on large-sized paper

Print

This table shows the total number of pages printed with print operations.

- Total: Total number of printout pages
- Large Size: Total number of printout pages printed on large-sized paper

Fax/Scan

- Total: Total number of pages scanned/total number of prints in the Fax and Scan modes.
- Large Size: Total number of pages scanned/total number of prints in the Fax and Scan modes for paper specified as large-size paper

Original Counter

- This counter shows the number of original pages that were scanned.

Paper Counter

- This counter shows the number of pages used for printing.

Fax TX

- Fax TX: Total number of pages transmitted with fax operations



Note

Counting automatically continues with user counters when using external server authentication.

The public user access is counted as "public" of the counter.

The user box administrator access is counted as "BoxAdmin" of the counter.

11.9.6 Viewing user counters

- 1 Display the Administrator Settings screen.
 - For details on displaying the Administrator Settings screen, refer to "[Displaying the Administrator Settings screen](#)" on page 11-36.
- 2 Touch [4 User Authentication/Account Track].
The User Authentication/Account Track screen appears.
- 3 Touch [2 User Authentication Settings].
The User Authentication Setting screen appears.
 - ? Why is [2 User Authentication Settings] not available?
 - [2 User Authentication Settings] is not available if "User Authentication" on the General Settings screen is set to "OFF".
- 4 Touch [3 User Counter].
- 5 Touch the button for the desired user, and then touch [Counter Details].
The Counter Details screen for the user appears.
- 6 Touch the button for the counter to be viewed, and then check the counter.
 - To clear the counters for the current user, touch [Clear Counter] in the Counter Details screen for the current user. A confirmation message appears, asking whether the counter should be cleared. To clear the counters for the displayed user, touch [Yes] in the confirmation message screen, and then touch [OK]. The maximum number allowed is not cleared.
 - To clear the counters for all users, touch [Reset All Counters] in the User Counter screen. A confirmation message appears, asking whether the counters should be cleared. To clear the counters for all users, touch [Yes] in the confirmation message screen, and then touch [OK]. The maximum number allowed is not cleared.

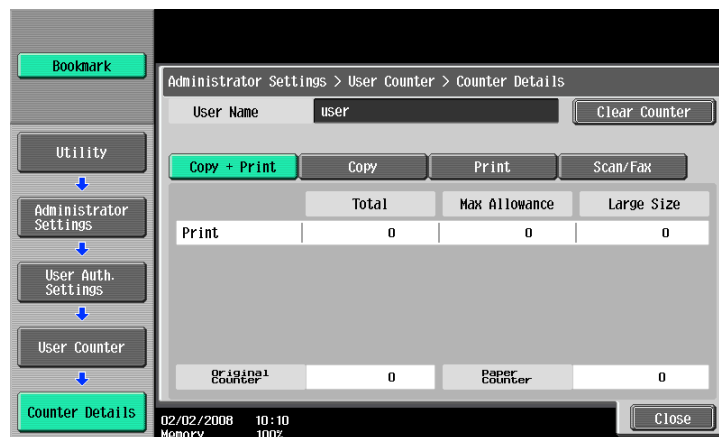

- 7 Touch [Close].

11.10 Account Track Setting

11.10.1 Account Track Registration

The password and number of prints allowed can be specified for each account using this machine.



Note

A total of 1,000 users and accounts can be registered on this machine.

- 1 Display the Administrator Settings screen.
 - For details on displaying the Administrator Settings screen, refer to "[Displaying the Administrator Settings screen](#)" on page 11-36.
- 2 Touch [4 User Authentication/Account Track].
The User Authentication/Account Track screen appears.
- 3 Touch [3 Account Track Settings].
The Account Track Setting screen appears.
- 4 Touch [1 Account Track Registration].
- 5 Touch the button for the desired account, and then touch [Edit].
The Edit screen for the account appears.

If "Account Name & Password" was selected:

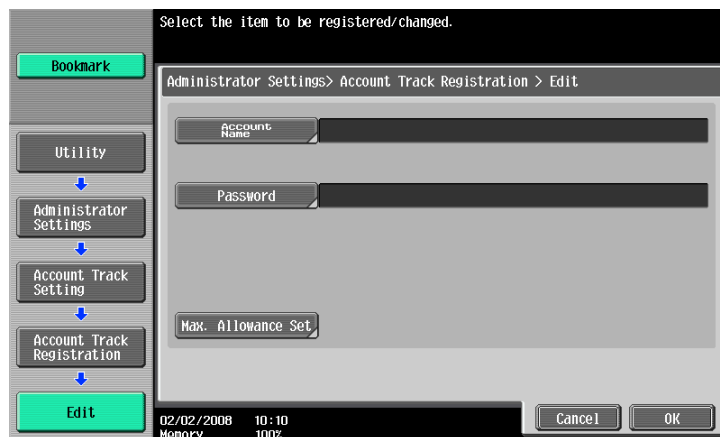

- If "Account Name & Password" was selected, the same account name cannot be used more than once.

If "Password Only" was selected:



- The screen that appears differs depending on the setting selected for "Account Track Input Method".

- 6 Touch [Account Name].

The Account Name screen appears.

- 7 Type in the account name (up to 8 characters long), and then touch [OK].
 - For details on typing in text, refer to ["Entering text" on page 14-2](#).
 - If [Name] was displayed, type in the account name (up to 20 characters), and then touch [OK].
 - If "Account Track Input Method" was set to "Account Name & Password", the same account name cannot be registered more than once.



The account name is set.

- 8 Touch [Password].
 - If "Account Track Input Method" was set to "Password Only", the same password cannot be registered more than once.

The Password screen appears.

- 9 Type in the password (up to 8 characters long), and then touch [OK].

A screen for retyping the password appears.

- 10 Retype the password specified in step 9, and then touch [OK].

The user password is set.

- 11 Touch [Max. Allowance Set].

The Max. Allowance Set screen appears.

- 12 To specify the maximum number of prints allowed, use the keypad to type in the desired value.

- To specify no maximum for color and black prints, touch [No Limit].



- Touch [All Accounts] to apply the settings in the current screen to all registered accounts. Touch [All Accounts], touch [OK], and then touch [OK] in the next screen that appears in order to display a message and apply the settings to all accounts. At this time, do not turn off the machine with the main power switch.

- 13 Touch [OK].

The maximum number of prints allowed is set.

14 Touch [OK].

- To delete the selected account information, touch [Delete].

11.10.2 Account Track Counter

The following data for each account can be checked.

Copy + Print

This table shows the total number of pages printed with copy and print operations.

- Total: Total number of printed pages
- Max Allowance: Limits specified during account registration for the number of pages
- Large Size: Total number of pages printed on large-sized paper

Copy

This table shows the total number of pages printed with copy operations.

- Total: Total number of copied pages
- Large Size: Total number of pages copied on large-sized paper

Print

This table shows the total number of pages printed with print operations.

- Total: Total number of printout pages
- Large Size: Total number of printout pages printed on large-sized paper

Fax/Scan

- Total: Total number of pages scanned/total number of prints in the Fax and Scan modes.
- Large Size: Total number of pages scanned/total number of prints in the Fax and Scan modes for paper specified as large-size paper

Original Counter

- This counter shows the number of original pages that were scanned.

Paper Counter

- This counter shows the number of pages used for printing.

Fax TX Count

- Total number of pages transmitted with fax operations



Note

The public user access is counted as "public" of the counter.

11.10.3 Viewing account counters

- 1 Display the Administrator Settings screen.
 - For details on displaying the Administrator Settings screen, refer to "[Displaying the Administrator Settings screen](#)" on page 11-36.
- 2 Touch [4 User Authentication/Account Track].
The User Authentication/Account Track screen appears.
- 3 Touch [3 Account Track Settings].
The Account Track Setting screen appears.
- 4 Touch [2 Account Track Counter].
- 5 Touch the button for the desired account, and then touch [Counter Details].
The Counter Details screen for the account appears.
- 6 Touch the button for the counter to be viewed, and then check the counter.
 - To clear the counters for the current account, touch [Clear Counter] in the Counter Details screen for the current account. A confirmation message appears, asking whether the counter should be cleared. To clear the counters for the displayed account, touch [Yes] in the confirmation message screen, and then touch [OK]. The maximum number allowed is not cleared.
 - To clear the counters for all accounts, touch [Reset All Counters] in the Account Track Counter screen containing a list of all accounts. A confirmation message appears, asking whether the counters should be cleared. To clear the counters for all accounts, touch [Yes] in the confirmation message screen, and then touch [OK]. The maximum number allowed is not cleared.

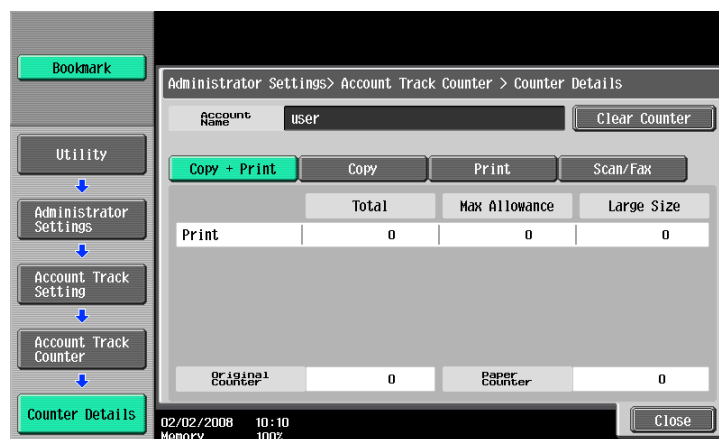

- 7 Touch [Close].

11.11 Password Rules

If password rules have been applied, the following limitations are applied to the passwords in order to increase security.

If password rules are applied and already specified passwords do not meet the password rules, those passwords are not accepted when they are entered. In that case, ask the administrator to change the passwords to meet the following conditions.



Detail

The following conditions apply to the characters used in passwords.

Uppercase and lowercase letters are differentiated.

Symbols other than the plus sign (+) and quotation mark (") can be used.

11.11.1 Conditions of the password rules

Administrator password

Limitations on the number of characters	Limitations on registering/changing
8 alphanumeric characters and symbols	<ul style="list-style-type: none"> A password that consists of a repetition of the same character cannot be registered. The same password as one before being changed cannot be registered.



Note

Use when specifying administrator settings.

User passwords

Limitations on the number of characters	Limitations on registering/changing
8 or more alphanumeric characters and symbols	<ul style="list-style-type: none"> A password that consists of a repetition of the same character cannot be registered. The same password as one before being changed cannot be registered.



Note

Use when specifying user authentication settings.

Account passwords

Limitations on the number of characters	Limitations on registering/changing
8 alphanumeric characters and symbols	<ul style="list-style-type: none"> A password that consists of a repetition of the same character cannot be registered. The same password as one before being changed cannot be registered.



Note

Use when specifying account track settings.

Box passwords

Limitations on the number of characters	Limitations on registering/changing
8 alphanumeric characters and symbols	<ul style="list-style-type: none"> A password that consists of a repetition of the same character cannot be registered. The same password as one before being changed cannot be registered.

**Note**

*Specify 8 characters (numbers, * or #) as the fax transmission password for boxes.*

Confidential document passwords

Limitations on the number of characters	Limitations on registering/changing
8 alphanumeric characters and symbols	<ul style="list-style-type: none">• A password that consists of a repetition of the same character cannot be registered.

**Note**

If any password not following the Password Rules, Secure Print cannot be performed.

11.12 Enhanced Security Mode

When enhanced security mode is applied on this machine, various security settings are set in order to increase security when managing scan data. Restrictions are applied to user operations, public user access is prohibited, and box operations and print jobs are limited.

There are various settings that must first be specified or are forcibly set in order for "Enhanced Security Mode" to be set to "ON". Before setting "Enhanced Security Mode" to "ON", be sure to check the settings for the security functions.



Reminder

If there are settings that are incompatible with the enhanced security Mode, "Enhanced Security Mode" cannot be set to "ON".



Detail

Certain conditions must be met in order for the enhanced security features to be applied. For details, contact your service representative.

The settings that must be specified or are forcibly set cannot be changed after "Enhanced Security Mode" is set to "ON".

Required settings

The following settings must first be specified in order to set "Enhanced Security Mode" to "ON".

Administrator mode parameters	Settings
User Authentication/Account Track—General Settings—User Authentication	Select "ON (External Server)" or "ON (MFP)".
System Connection—Open API Settings—SSL	The button must be displayed.
Security Settings—Administrator Password	Specify a password that meets the password rules.
Security Settings—HDD Settings—HDD Lock Password *Otherwise, install the optional security kit.	Specify the hard disk locking password.
Security Settings/Security Details/Prohibited Functions When Authentication Error/Release Time Settings	Specify 5 minutes or longer.
Security Settings/Flash Memory Lock Password	Specify the flash memory locking password.



Detail

If "Account Track" is set to "ON" in the General Settings screen, set "Account Track Input Method" to "Account Name & Password".

[SSL] appears when a certificate is registered with PageScope Web Connection.

Changed settings

For increased security, the following settings are set when "Enhanced Security Mode" is set to "ON".

Administrator mode parameters	Changed settings
System Settings—Restrict User Access—Restrict Access to Job Settings—Registering and Changing Addresses	Set to "Restrict".
User Authentication/Account Track—General Settings—Public User Access	Set to "Restrict".
User Authentication/Account Track—User Authentication Settings—Administrative Settings—User Name List	Set to "OFF".
User Authentication/Account Track—Print Without Authentication	Set to "Restrict".
Security Settings—User Box Administrator Setting	Set to "Restrict".
Security Settings—Security Details—Password Rules	Set to "Enable".

Administrator mode parameters	Changed settings
Security Settings—Security Details—Prohibited Functions When Authentication Error	Set to "Mode 2" and three times or less for checking.
Security Settings—Security Details—Confidential Document Access Method	Set to "Mode 2".
Security Settings—HDD Setting—Overwrite Temporary Data	Set to "Mode 1".



...

Note

The number of times for checking for "Prohibited Functions When Authentication Error" can be changed to a number between 1 and 3.

A changed setting cannot be changed when "Enhanced Security Mode" is set to "OFF".

When "Password Rules" is set to "Enable", a password that does not meet the password rules is considered a failed attempt during authentication. For details on the password rules, refer to ["Password Rules" on page 11-76](#).

When "Overwrite Temporary Data" is set to "Mode 2", it cannot be changed to "Mode 1" even if "Enhanced Security Mode" is "ON".

For details on the changed network settings, refer to the User's Guide [Network Scan/Fax/Network Fax Operations].

User operation limitations

When "Enhanced Security Mode" is set to "ON", an icon appears in the screen and limitations are placed on the user for the following operations.

- A public user cannot use this machine.
- The list of users does not appear in the user authentication screen.
- When user authentication has failed the specified number of times, the control panel can no longer be operated. If operation of the control panel is restricted, touch [Release], and then select the items whose operation restrictions are canceled.
- The destination cannot be changed by the user.
- This machine's counter data cannot be retrieved by PageScope Net Care or PageScope VISUALCOUNT-MASTER.
- An application performing the write operation with SNMP v1/v2c cannot be connected.
- Write users using SNMP v3 must be authenticated.



...

Note

For details on the limitations placed on the user for box operations, refer to the User's Guide [Box Operations].

For details on the limitations placed on the user for printing, refer to the User's Guide [Print Operations].

For details on canceling operation restrictions applied when authentication failed, refer to ["Security Settings" on page 11-33](#).

12

**Authentication Unit
(Biometric Type AU-101)**

12 Authentication Unit (Biometric Type AU-101)

12.1 Using Authentication Unit (Biometric Type) AU-101

The Authentication Unit (Biometric Type) AU-101 is a biometric authentication system that performs user authentication by scanning vein patterns in a finger. Log on to this machine and print job operation can be authenticated with finger vein patterns when using this machine with user authentication settings specified.

The status of the authentication unit is indicated by a status indicator and tone.

Status indicator	Device status
Lit (green)	Standing by/authentication completed
Flashing (green)	Authenticating/scanning
Lit (red)	Authentication failed/scanning failed
Off	The authentication unit is not detected.

Tone	Device status
One short beep	Starting to scan
One short beep	Retrying after authentication failed
One short beep	Authentication completed
Two short beeps	Authentication failed

In order to use the authentication unit, user finger vein patterns must first be registered with the machine.

A registered user can log on to this machine or print a print job after completing authentication with their finger vein patterns.

The following procedures describe how to specify the necessary settings on the machine, register users, and perform the logon and print job operations after completing authentication.



...

Note

Align the index finger with the indentation and notch in the scanner, and then position the finger so that the tip lightly touches the edge of the scanner. Place your thumb and middle finger down to hold the authentication unit in place on both sides, and avoid moving the index finger being used for authentication.

For details on positioning the finger on the authentication unit, refer to the Quick Guide Authentication Unit (Biometric Type AU-101).



...

Reminder

Do not place any object other than your finger in the scanner of the authentication unit while scanning, otherwise the device may malfunction.

Do not disconnect the cable connecting the authentication unit to the computer while scanning, otherwise the system may become unstable.

12.1.1 Settings of this machine



Detail

User authentication on the machine must be set for machine authentication.

- 1 From the control panel of the multifunctional product, touch [4 User Authentication/Account Track] on the Administrator Settings screen, and then touch [1 General Settings].
- 2 Set "User Authentication" to "ON (MFP)", and then touch [OK].
 - External server authentication is not supported.

- When combined with account track settings, set "Synchronize User Authentication & Account Track" to "Synchronize". If "Do Not Synchronize" is selected, the Touch & Print function cannot be used.

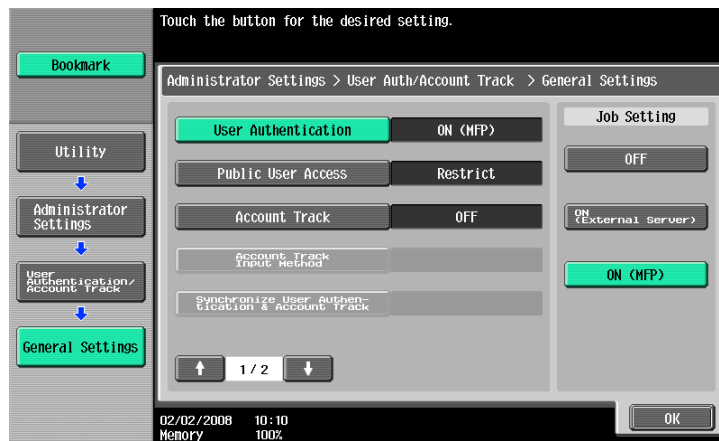

- 3 Touch [8 Authentication Device Settings], then [1 General Settings], then [Bio Authentication].
- 4 Select the desired settings under "Beep Sound" and "Operation Settings".



- Under "Beep Sound", select whether or not a beep is produced when scanning of the finger vein pattern is completed successfully.
- Under "Operation Settings", select the logon method after registration.
 1-to-many authentication: Logon is possible simply by positioning the finger.
 1-to-1 authentication: Logon is possible by entering a user name and positioning the finger.
- For details on logging on, refer to "[Logging on to this machine](#)" on page 12-16.

- 5 Touch [OK], and then touch [OK] in the next screen that appears.
- 6 Touch [2 Touch & Print Setting].



- 7 Select the printing method for the Touch & Print function.



- Print All Jobs: Select this setting to print all documents after completed authentication once when multiple documents are saved in the Touch & Print user box.
- Print Each Job: Select this setting to print one document saved in the Touch & Print user box each time authentication is completed.
- If "Off" is selected, the Touch & Print function cannot be used.
- For details on the Touch & Print function, refer to "[Touch & Print function](#)" on page 12-17.

- 8 Touch [OK].

- 9 Touch [3 Logoff Settings].

- 10 Select whether or not the user is logged off when scanning of the document is finished after the user has logged on to this machine.



- 11 Touch [OK].

- 12 Touch [Close], and then touch [Close] in the next screen that appears.

12.1.2 Registering users

There are two methods for registering users.

- Connecting the authentication unit to the machine and registering directly from the machine
- Connecting the authentication unit to a computer and registering using Data Administrator



Detail

Registered user data is stored on the hard disk of the machine. If the user authentication method on the machine is changed or the hard disk is reformatted, the registered user data is erased.

Registering from the control panel of this machine

- 1 From the control panel of the machine, touch [4 User Authentication/Account Track] on the Administrator Settings screen, and then touch [2 Authentication System], then [2 User Registration].
 - [2 User Authentication Settings] is not available if "User Authentication" on the General Settings screen is set to "OFF".
- 2 Touch the button for a registration number, and then touch [Edit].



- 3 Touch [Register Auth. Info.].



- 4 Touch [Edit].

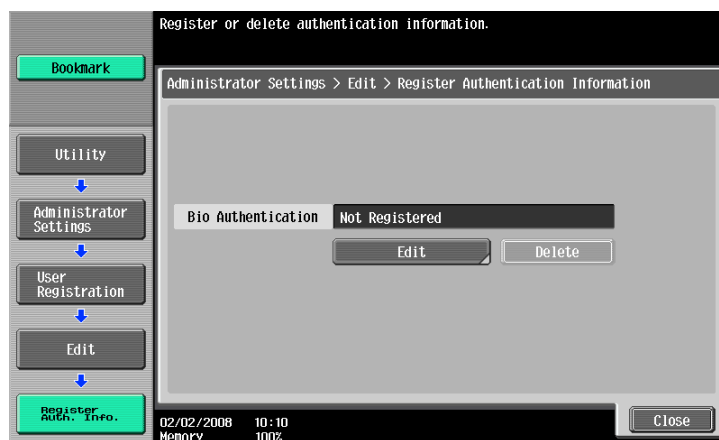

- 5 Position the finger on the authentication unit to scan the finger vein pattern.

- Scan the finger vein pattern three times, removing and repositioning the same finger, and touch [OK] after each time.



- 6 Touch [Close], and then touch [Close] in the next screen that appears.
- 7 Type the user name and the password.
- 8 If desired, specify the function limitations.
- 9 Touch [OK].
- 10 Touch [Close].

Registering from Data Administrator

In order to use Data Administrator, settings must be specified on the machine and the setup procedure must be performed. The setup procedure includes installing BioDriver (USB-Driver) of the authentication unit, then installing Data Administrator Bio Plugin.



Reminder

Data Administrator ver. 4.0 or later must first be installed on the computer. For details on the operating environment and installation procedure for Data Administrator, refer to the User's Guide for the Data Administrator.

Checking the currently installed version

- 1 From the "Help" menu of Data Administrator, click "Version Information".
 - If the version appears as "3.x": This software cannot be used. Install version 4.x.
 - If Data Administrator ver. 3.x is installed, it is removed when version 4.x is installed.
- 2 Click the [Plug-in version] button.
- 3 From the "Plug-in information list", check the version of the Data Administrator plug-in.

- If the plug-in version appears as "4.x": This software can be used.

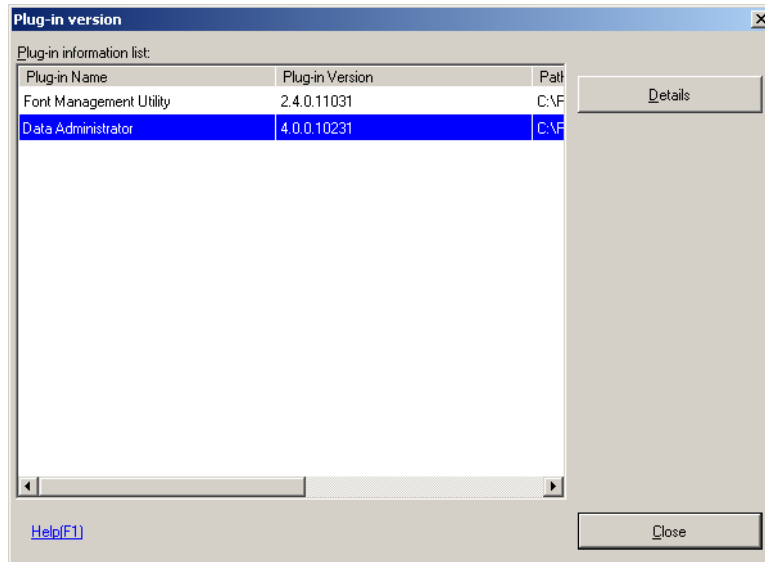

Setup

- 1 Turn off the machine with the main power switch, and then disconnect the authentication unit from the machine.
- 2 Install BioDriver (USB-Driver).
 - Plug the cable from the authentication unit into the USB port on the computer.
 - The Found New Hardware Wizard starts.
- 3 Select "Yes, now and every time I connect a device", and then click [Next].



- 4 Insert the application CD-ROM included with the authentication unit into the CD-ROM drive of the computer.

- 5 Select "Install from a list or specific location (Advanced)", and then click [Next].

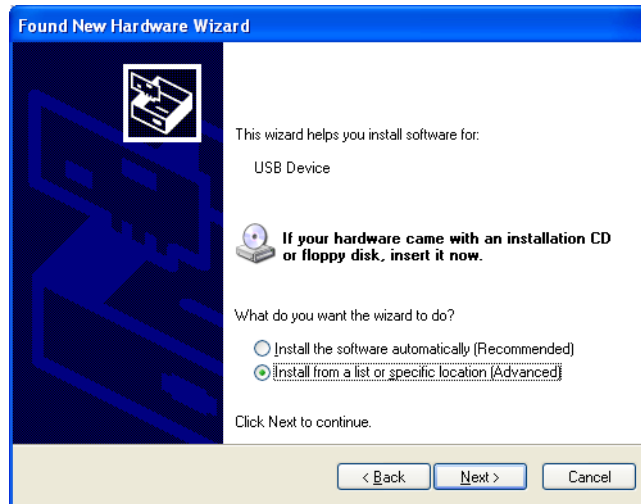

- 6 Select the "Include this location in the search" check box, check that the application CD-ROM appears as a location to be searched, and then click [Next].

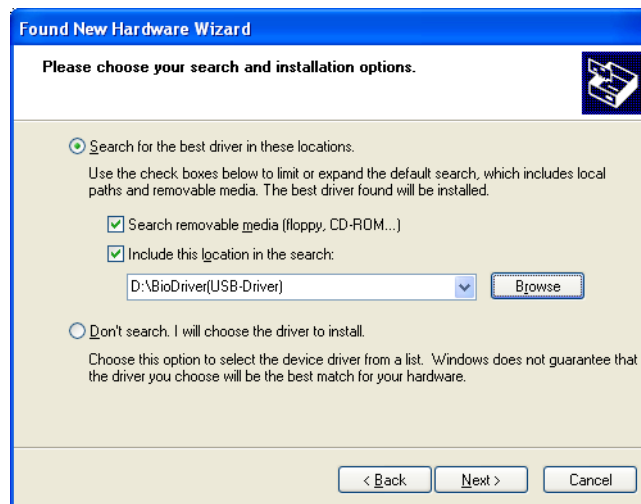

- If the application CD-ROM does not appear as a location to be searched for the driver, click [Browse], select the BioDriver (USB-Driver) folder on the CD-ROM, and then click [OK].



The installation begins.

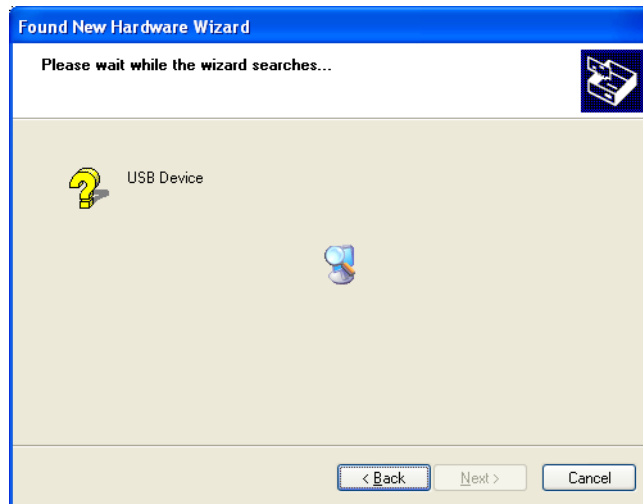

- 7 Click [Finish].



- 8 Repeat steps 5 through 7.
The installation of BioDriver (USB-Driver) is completed.
- 9 Install Data Administrator Bio Plugin.
Open the DA_Bio_Plugin folder on the application CD-ROM, and then click "setup.exe".
- 10 Select the language, and then click [OK].

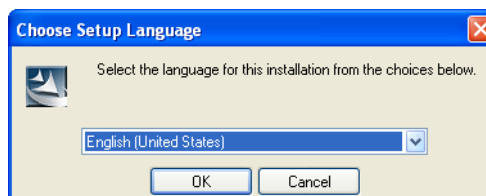

The installer starts up.

- 11 Follow the instructions that appear on the screen to complete the installation.

12 Click [Next].



13 Select "I accept the terms of the license agreement", and then click [Next].

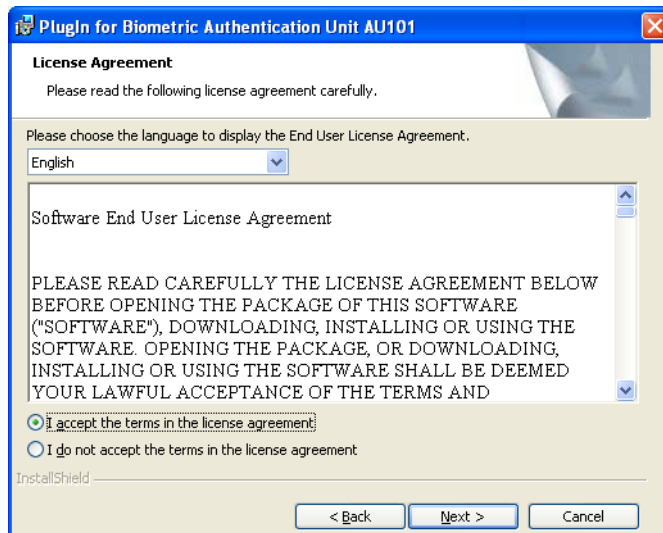

14 Click [Install].

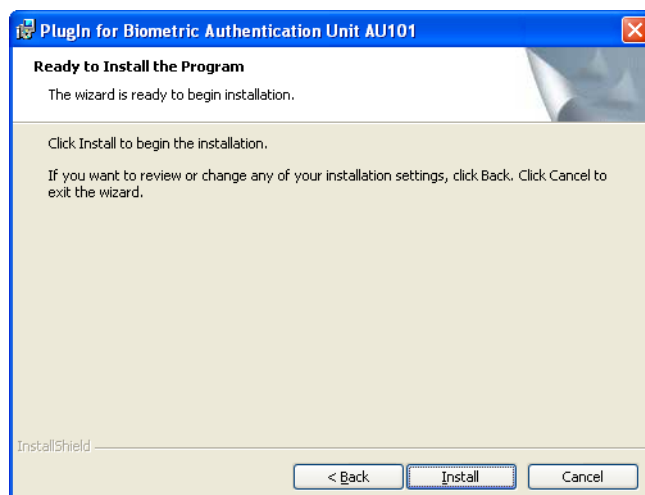

15 Click [Finish].

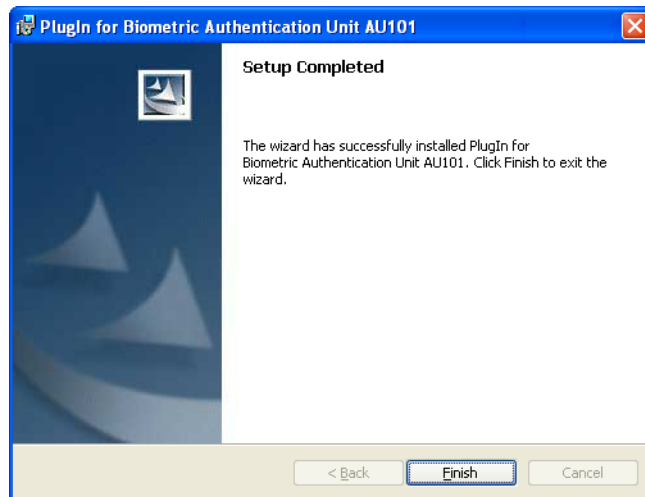

Data Administrator Bio Plugin is installed, and the setup is completed.

Registering users



Reminder

In order to register users with Data Administrator, the authentication unit must be connected to the USB port of the computer, and the computer and this machine must be connected over a network.

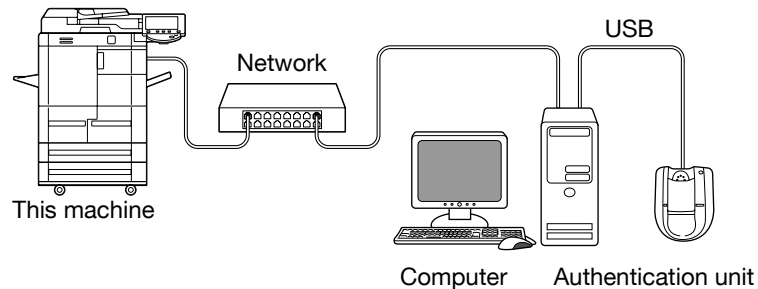

- 1 If the authentication unit is connected to the machine, turn off the machine with the main power switch, and then disconnect the authentication unit.
 - If the authentication unit is connected to the computer, continue with step 4.
 - When the machine is turned off, then on again with the main power switch, wait at least 10 seconds to turn the machine on after turning it off. The machine may not operate correctly if it is turned on immediately after being turned off.
 - Hold the plug when plugging and unplugging the USB cable, otherwise the cable may be damaged.
- 2 Turn on the machine with the main power switch.
- 3 Connect the authentication unit to the USB port of the computer installed with Data Administrator.
 - Do not connect other USB devices to the same port where the authentication unit is connected. If enough USB power is not provided, the authentication unit may not operate correctly.
 - When using a USB hub, be sure to use a self-powered USB hub that can provide 500 mA or more.
 - After connecting the authentication unit, wait at least 5 seconds before operating it.

- 6 Select a template, and then click [OK].

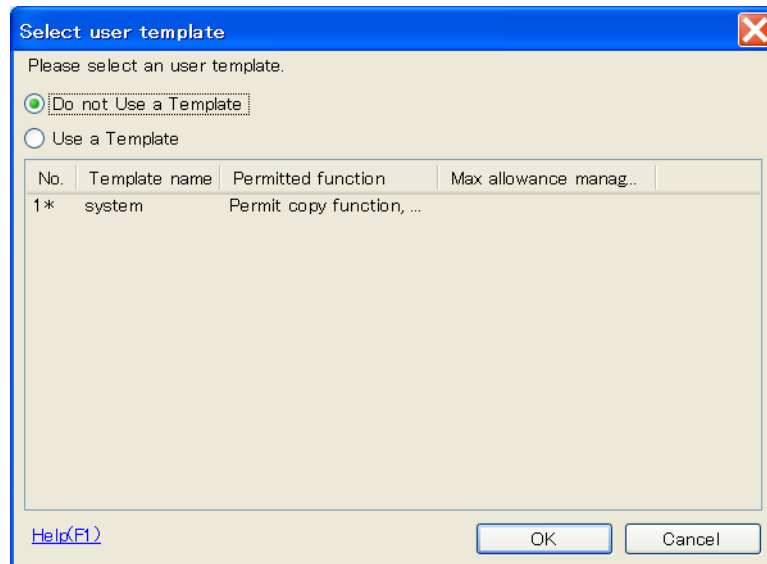

The User settings dialog box appears.

- 7 Type in the user name and password, click the Vein Authentication tab, and then click [Import].
- If desired, type in the e-mail address.

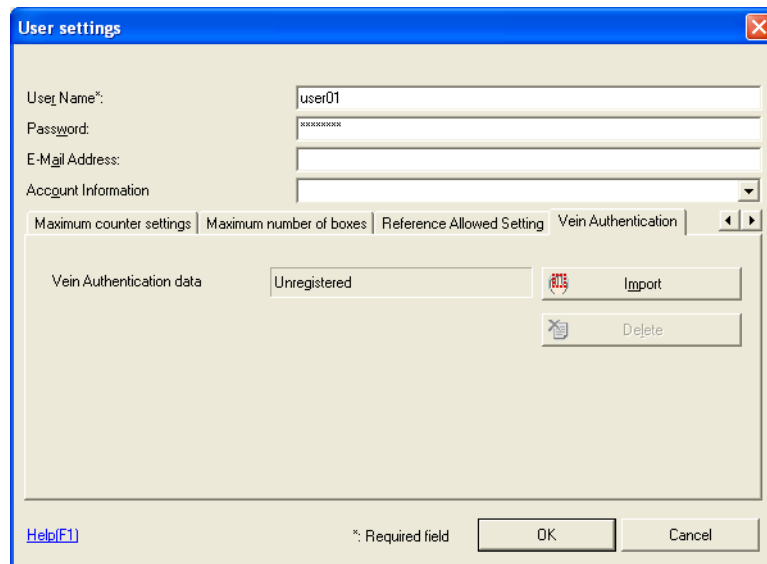

- 8 Position the finger on the authentication unit, and then click [Start reading].
 - Scan the finger vein pattern three times, removing and repositioning the same finger each time.

Registering Vein Authentication

User Name:

Result:

Step	Status
1st	-
2nd	-
3rd	-

In order to improve the accuracy of vein data, the vein is photographed 3 times.
Place your finger on the vein reader and click the [Start reading] button.
Lift and place your finger again for each photo.

- 9 Click [Register].
- 10 Click [OK].
 - Repeat steps 5 through 10 until all users have been registered.

User settings

User Name*:

Password:

E-Mail Address:

Account Information:

Maximum counter settings | Maximum number of boxes | Reference Allowed Setting | **Vein Authentication**

Vein Authentication data: Unregistered

[Help\[F1\]](#) *: Required field

11 Click [Export to the device].

- To change the registered data, select the user name, and then click [Edit].

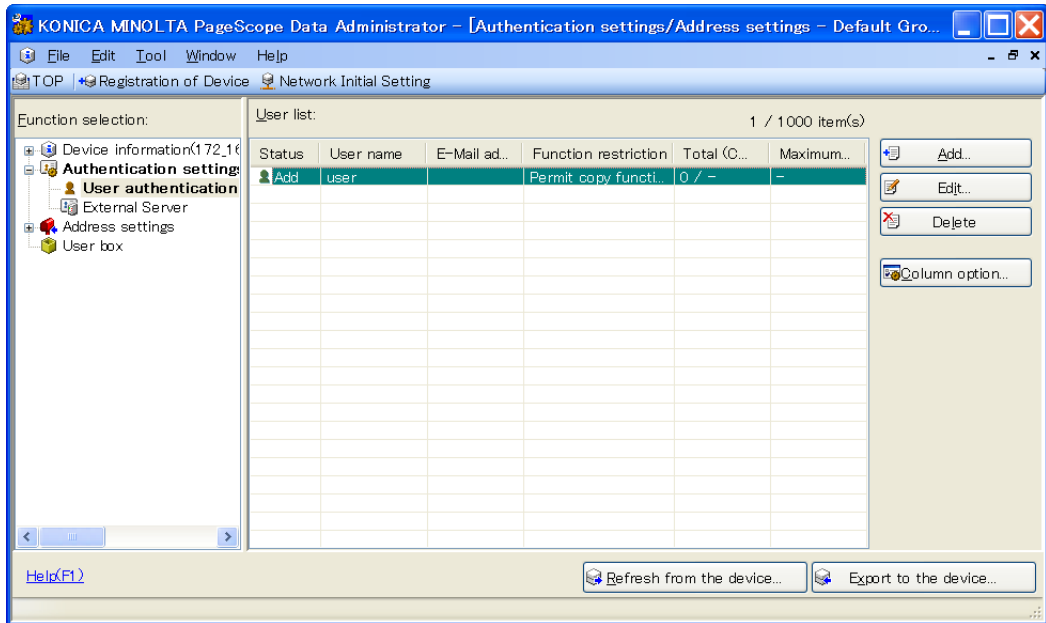
**12** Click [Write].

- Data Administrator is equipped with a batch copy feature that allows the registered user data to be specified on multiple machines specified to be used with the authentication unit.

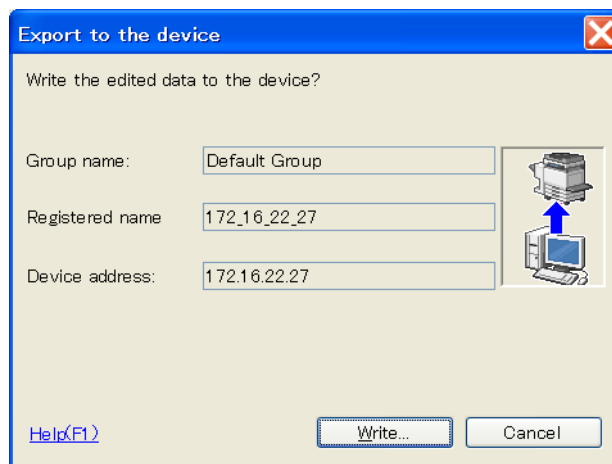

The registered user data is specified on the machine.

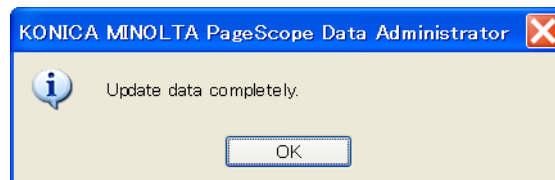
13 Click [OK].**14** Disconnect the authentication unit from this USB port of the computer.**15** Turn off the machine with the main power switch, connect the authentication unit, and then turn on the machine with the main power switch.

- When the machine is turned off, then on again with the main power switch, wait at least 10 seconds to turn the machine on after turning it off. The machine may not operate correctly if it is turned on immediately after being turned off.
- Hold the plug when plugging and unplugging the USB cable, otherwise the cable may be damaged.

12.1.3 Logging on to this machine

Follow the procedures described below to log on to this machine by completing authentication with finger vein patterns.

When "1-to-many authentication" has been specified

- 1 Position the registered finger on the authentication unit.



- 2 The user is authenticated, and the Basic screen appears.

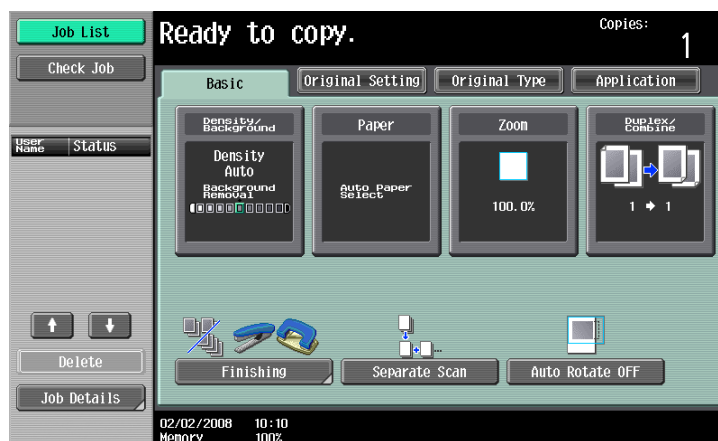

When "1-to-1 authentication" has been specified

- 1 Type in the user name.

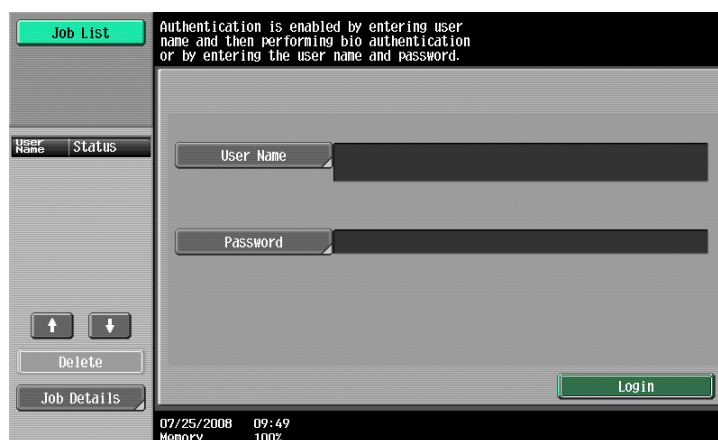

- 2 Position the registered finger on the authentication unit.

The user is authenticated, and the Basic screen appears.

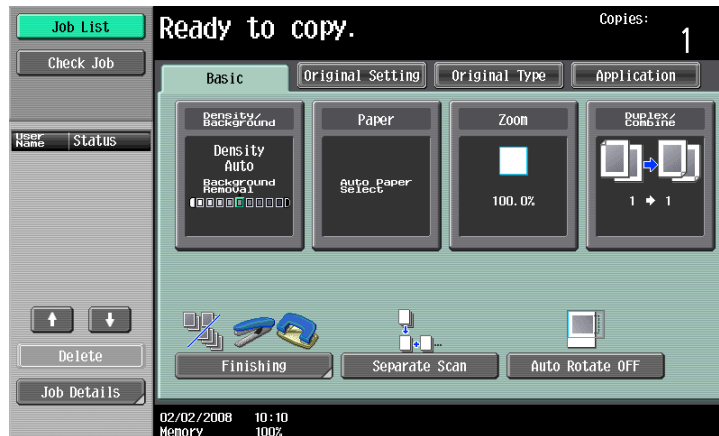

Note

Note If authentication fails many times, the authentication data may not be registered correctly. Therefore, register the user again.

12.1.4 Touch & Print function

Print jobs sent from a computer are saved in the Touch & Print user box on the machine and can be printed after authentication is completed with finger vein patterns. This is called the Touch & Print function.

In addition, documents saved in the Touch & Print user box can be checked and specified to be printed from the control panel of the machine.

The following printer drivers and computer operating systems are compatible with the Touch & Print function

Printer driver	Page description language	Supported operating systems
PCL Driver	PCL6	Windows NT 4.0 (Service Pack 6a), Windows 2000 Professional (Service Pack 4 or later), Windows XP Home Edition/Professional (Service Pack 2 or later), Windows XP Professional x64, Windows Server 2003, and Windows Server 2003 x64
PostScript Driver (PS driver)	PostScript3 Emulation	Windows 2000 Professional (Service Pack 4 or later), Windows XP Home Edition/Professional (Service Pack 2 or later), Windows XP Professional x64, Windows Server 2003, and Windows Server 2003 x64
PostScript PPD driver (PS-PPD)		Mac OS X 10.2, Mac OS X 10.3, and Mac OS X 10.4



Detail

To use the Touch & Print function, select "1-to-many authentication" under "Operation Settings" and set "Touch & Print Setting" to "ON".

For details on specifying the settings mentioned above, refer to "Settings of this machine" on page 12-2



Note

For details on the printer driver settings and Box mode functions, refer to the User's Guide included with the machine.

Touch & Print (For Windows)

-Specifying settings on the Configure tab

- 1 For Windows 2000/NT 4.0, click the [Start] button, point to "Settings", and then click "Printers". For Windows XP/Server 2003, click the [Start] button, and then click "Printers and Faxes". For Windows Vista, click the [Start] button, and then click "Control panel", "Hardware and Sound", and "Printers"
 - If "Printers and Faxes" does not appear in the Start menu in Windows XP/Server 2003, open the Control Panel from the Start menu, select "Printers and Other Hardware", and then select "Printers and Faxes".
 - For Windows Vista, if the control panel is in the classic view, double-click "Printers".
- 2 Right-click the icon of the installed printer, and then click "Properties".
- 3 Click the Configure tab.

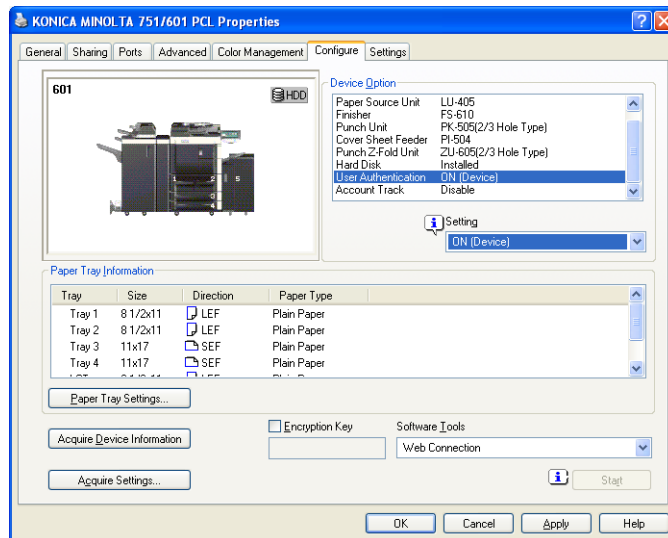

- 4 Select "User Authentication" under "Device Option".
- 5 Select "ON (Device)" from the "Setting" drop-down list.
- 6 Click [Apply], and then click [OK].

-Sending a print job

- 1 Open the data in the application, click [File], and then click [Print].
- 2 Check that the printer name has been selected in "Printer Name" or "Select Printer". If the printer is not selected, click to select the printer.
 - The Print dialog box differs depending on the application.

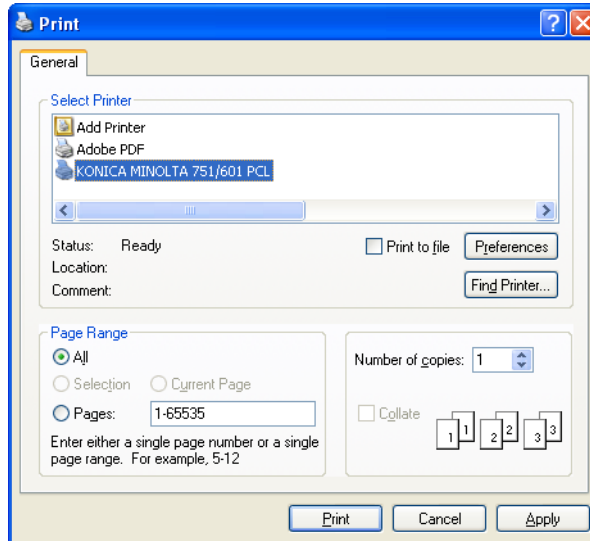

- 3 Click [Preferences] (or [Properties]).
- 4 Click the Basic tab.

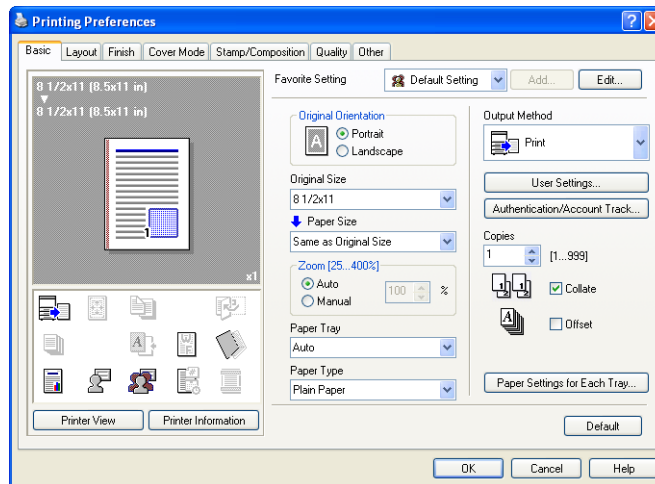

- 5 From the "Output Method" drop-down list, select "Print".
- 6 Click the [Authentication/Account Track] button.

- 7 Select "Recipient User", and then enter the user name and password.

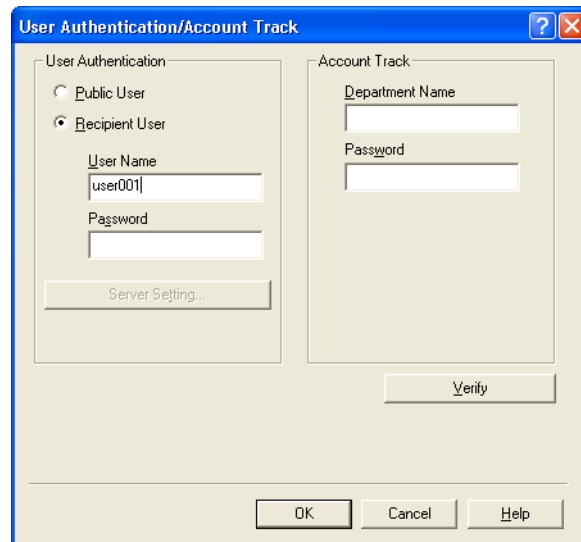

- 8 Click [Verify] to check the user ID.

- 9 Click [OK].

- If the user name or the password is incorrect, type in the correct information.

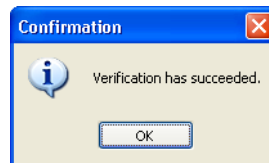

- 10 Click the [OK] button.

- 11 Specify the desired settings, and then click [OK].

- 12 Click [Print].

- 13 The print job is sent.

- 14 Position the registered finger on the authentication unit.

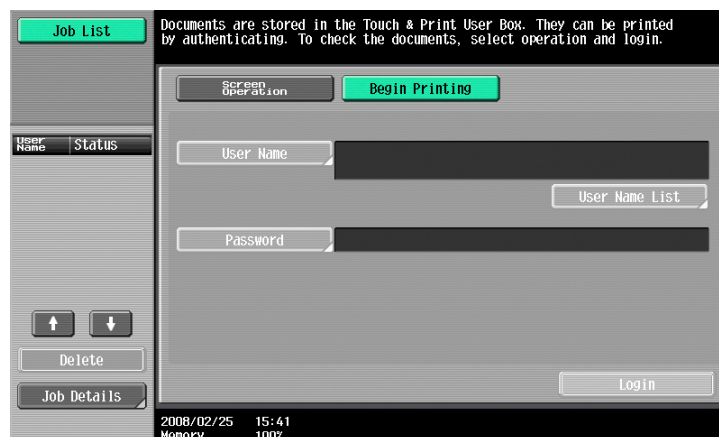

- Make sure that "Begin Printing" is selected.
- To select the print job to be printed, touch [Screen Operation]. For details, refer to ["Selecting the print job to be printed from the control panel" on page 12-22](#).

The user is authenticated, and the print job is printed.

Touch & Print (for Macintosh)**-Sending a print job**

- 1 Open the data in the application, click [File], and then click "Print".
- 2 Check that the printer name has been selected.
 - The Print dialog box differs depending on the application.

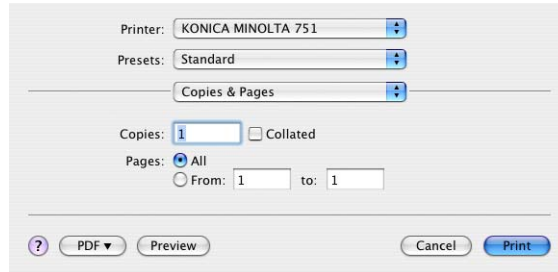

- 3 From the drop-down menu, select "Output Method".
- 4 From the "Output Method" drop-down list, select "Print".

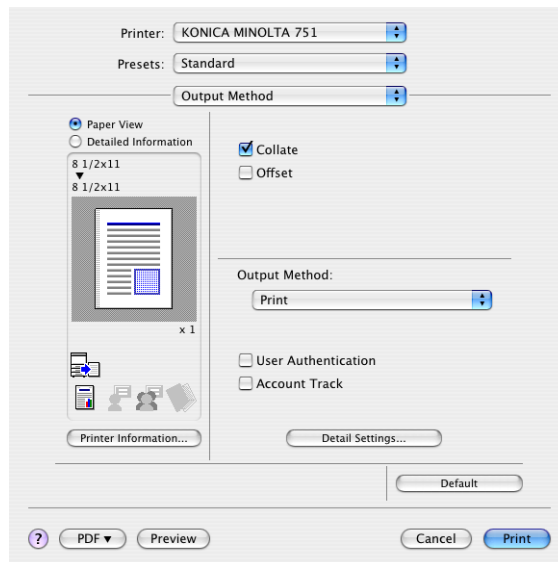

- 5 Select the "User Authentication" check box. The User Authentication dialog box appears.
- 6 Select "Recipient User", and then enter the user name and password.



- 7 Click the [OK] button.

- 8 Specify the desired settings, and then click [Print].
The print job is sent.
- 9 Position the registered finger on the authentication unit.

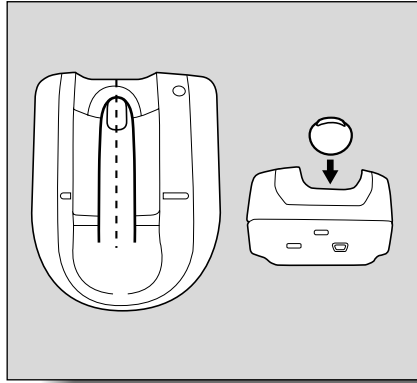

- Make sure that "Begin Printing" is selected.
 - To select the print job to be printed, touch [Screen Operation]. For details, refer to ["Selecting the print job to be printed from the control panel" on page 12-22](#).
- The user is authenticated, and the print job is printed.

Selecting the print job to be printed from the control panel

Follow the procedure described below to select the document to be printed from those saved in the Touch & Print user box.

- 1 Touch [Screen Operation].

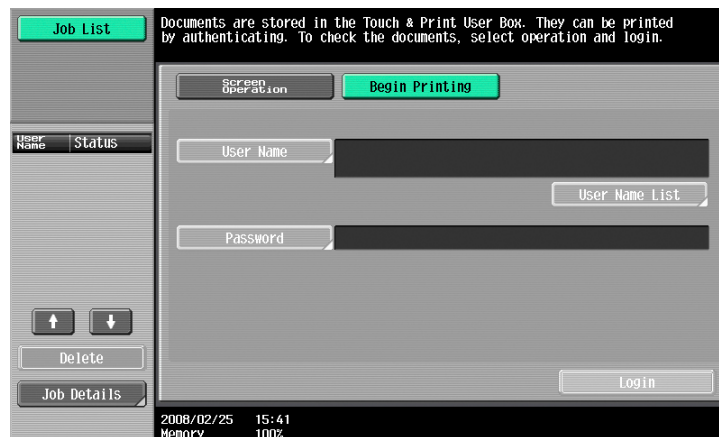

- 2 Position the registered finger on the authentication unit.

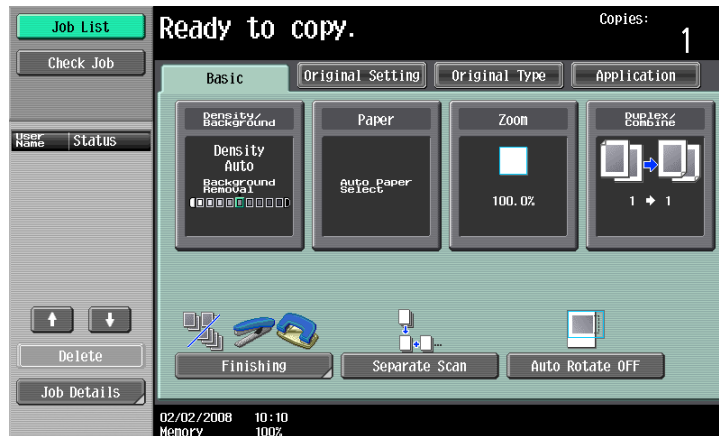

The user is authenticated, and the Basic screen appears.

- 3 Press the [User Box] key in the control panel.

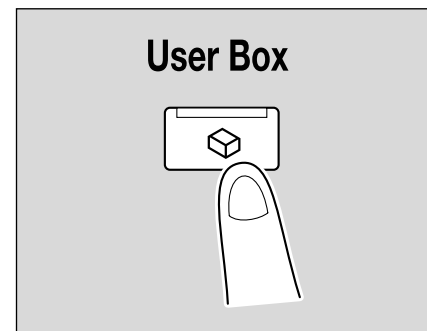

- 4 Touch [Use Document].

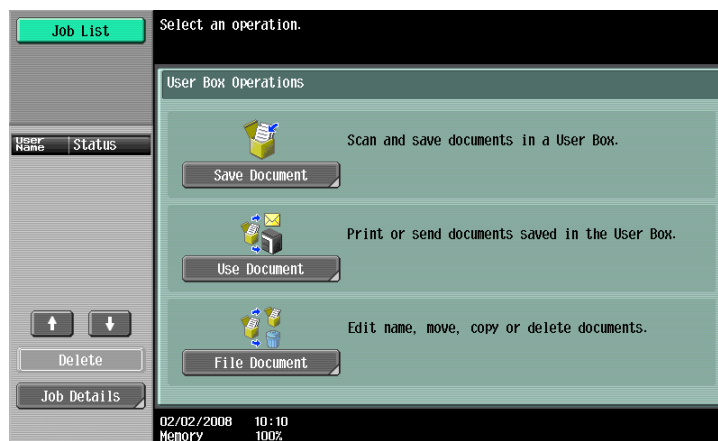

5 Touch [System User Box].



6 Touch [Touch & Print User Box], and then touch [OK].

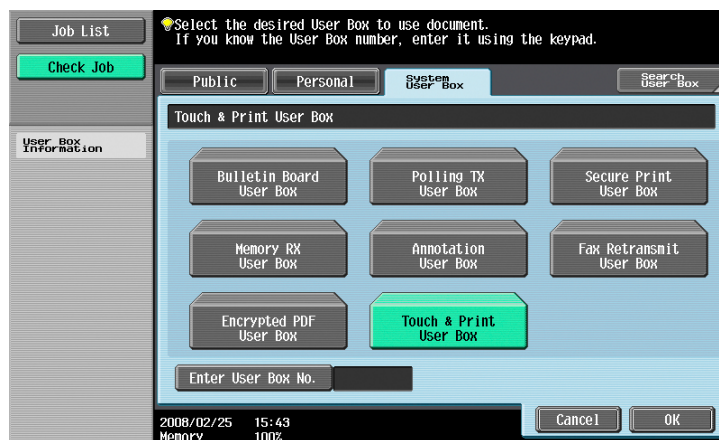

7 Select the document to be printed.

- Multiple documents can be selected.
- To select all documents, touch [Select All].
- To cancel the selection of all documents, touch [Reset].
- To check various information, such as the date/time when the document was stored and the document name, touch [Detail View].

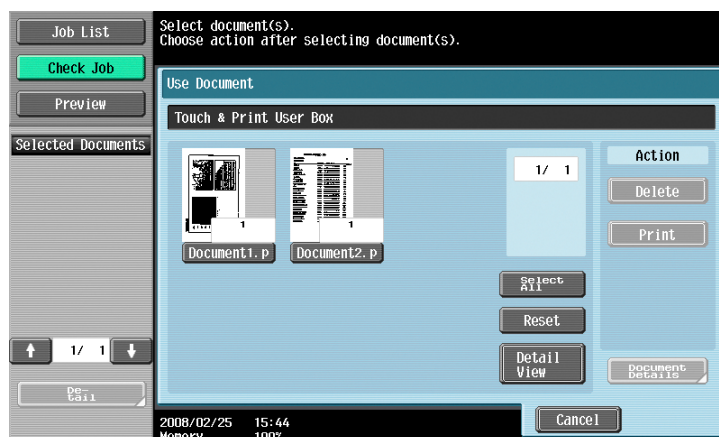

8 Touch [Print] under "Action".

- To delete the document, touch [Delete].
- To check the document details, touch [Document Details].
- To cancel the operation, touch [Cancel].

The selected document is printed.

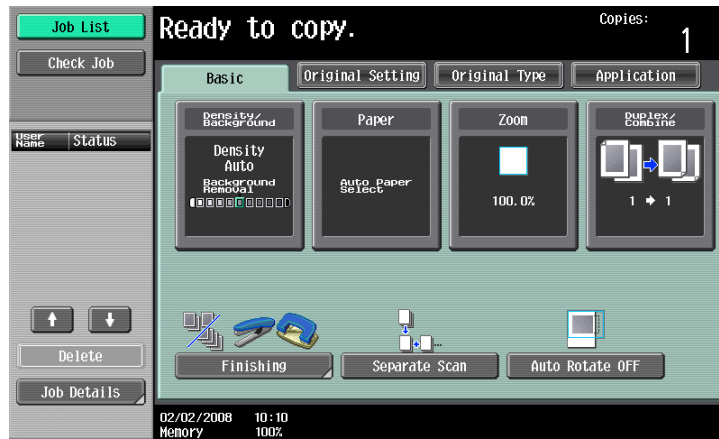
**Note**

If authentication fails many times, the authentication data may not be registered correctly. Therefore, register the user again.

13

**Authentication Unit (IC Card
Type AU-201)**

13 Authentication Unit (IC Card Type AU-201)

13.1 Using Authentication Unit (IC Card Type) AU-201

Authentication Unit (IC Card Type) AU-201 is an IC card authentication system that performs user authentication by IC cards. Log on to this machine and print job operation can be authenticated with IC cards when using this machine with user authentication settings specified.

In order to use the authentication unit, user IC card IDs must first be registered with the machine.

A registered user can log on to this machine or print a print job after completing authentication with their IC card IDs.

The following procedures describe how to specify the necessary settings on the machine, register users, and perform the logon and print job operations after completing authentication.



...

Note

For details on positioning the IC card on the authentication unit, refer to the Quick Guide Authentication Unit (IC Card Type AU-201).



...

Reminder

Do not disconnect the USB cable while the authentication unit is being used, otherwise the system may become unstable.

Do not store the IC card within 40 mm of the card scanning area.

13.1.1 Settings of this machine



Detail

User authentication on this machine must be set for machine authentication.

- 1 From the control panel of this machine, touch [4 User Authentication/Account Track] on the Administrator Settings screen, and then touch [1 General Settings].
- 2 Set "User Authentication" to "ON (MFP)", and then touch [OK].
 - For details on specifying settings for "Public User Access" and "Account Track", refer to the User's Guide [Copy Operations] included with this machine.
 - External server authentication is not supported.
 - When combined with account track settings, set "Synchronize User Authentication & Account Track" to "Synchronize". If "Do Not Synchronize" is selected, the Touch & Print function cannot be used.



- 3 Touch [Yes], and then touch [OK].

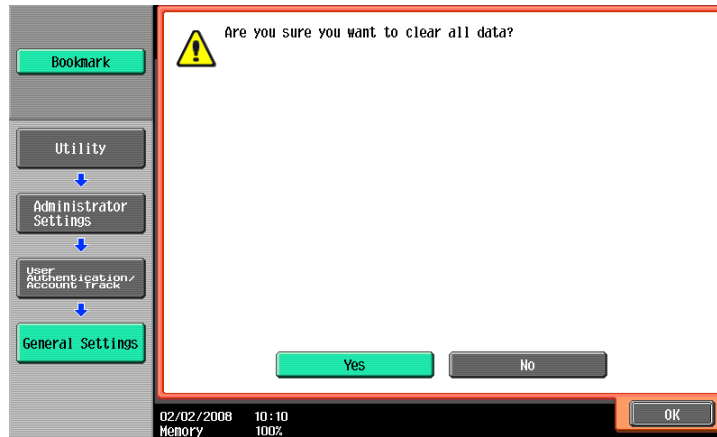

- 4 Touch [8 Authentication Device Settings], then [1 General Settings], then [Card Authentication].

- 5 Select the desired settings under "IC Card Type" and "Operation Settings".

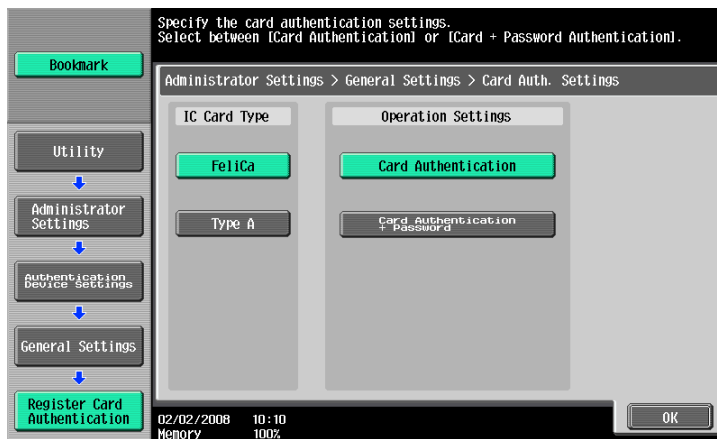

- Under "Operation Settings", select the logon method after registration.
 Card Authentication: Logon is possible simply by positioning the IC card.
 Card Authentication + Password: Logon is possible by positioning the IC card and entering the password. If users are registered with "Card Authentication + Password" selected, the Touch & Print function cannot be used.
- For details on logging on, refer to "[Logging on to this machine](#)" on page 13-16.

- 6 Touch [OK], and then touch [OK] in the next screen that appears.

- 7 Touch [2 Touch & Print Setting].

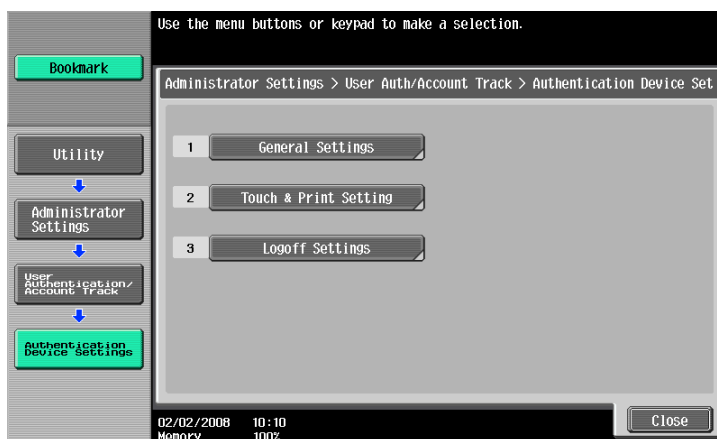

- 8 Select the printing method for the Touch & Print function.



- Print All Jobs: Select this setting to print all documents after completed authentication once when multiple documents are saved in the Touch & Print user box.
- Print Each Job: Select this setting to print one document saved in the Touch & Print user box each time authentication is completed.
- If "Off" is selected, the Touch & Print function cannot be used.
- For details on the Touch & Print function, refer to "[Touch & Print function](#)" on page 13-18 .

- 9 Touch [OK].

- 10 Touch [3 Logoff Settings].

- 11 Select whether or not the user is logged off when scanning of the document is finished after the user has logged on to this machine.



- 12 Touch [OK].

- 13 Touch [Close], and then touch [Close] in the next screen that appears.

13.1.2 Registering users

There are two methods for registering users.

- Connecting the authentication unit to this machine and registering directly from the machine
- Connecting the authentication unit to a computer and registering using Data Administrator



Detail

Registered user data is stored on the hard disk of this machine. If the user authentication method on the machine is changed or the hard disk is reformatted, the registered user data is erased.

Registering from the control panel of this machine

- 1 From the control panel of this machine, touch [4 User Authentication/Account Track] on the Administrator Settings screen, and then touch [2 User Authentication Settings], then [2 User Registration].
- 2 Touch the button for a registration number, and then touch [Edit].



- 3 Touch [Register Auth. Info.].



- 4 Touch [Edit].

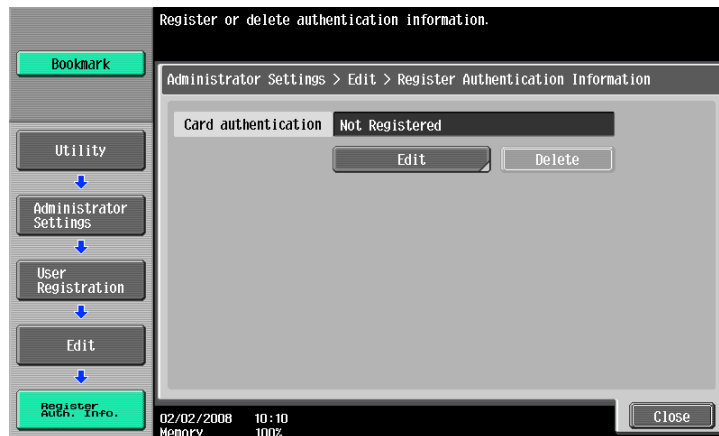

- 5 Position the IC card on the authentication unit, and then touch [OK].



- 6 After the message "Registered" appears, touch [Close], and then touch [Close] in the next screen that appears.
- 7 Type the user name and the password.
- 8 If desired, specify the function limitations.
- 9 Touch [OK].
- 10 Touch [Close].

Registering from Data Administrator

In order to use Data Administrator, settings must be specified on the machine and the setup procedure must be performed. The setup procedure includes installing IC Card Driver (USB-Driver) of the authentication unit, then installing Data Administrator IC Card Plugin.



Reminder

Data Administrator ver. 3.0 or later must first be installed on the computer. For details on the operating environment and installation procedure for Data Administrator, refer to the User's Guide for the Data Administrator..

Setup

- 1 Turn off the machine with the main power switch, and then disconnect the authentication unit from the machine.
- 2 Install IC Card Driver (USB-Driver).
 - Plug the cable from the authentication unit into the USB port on the computer.
 - The Found New Hardware Wizard starts.

- 3 Select "Yes, now and every time I connect a device", and then click [Next].



- 4 Insert the application CD-ROM included with the authentication unit into the CD-ROM drive of the computer.

- 5 Select "Install from a list or specific location (Advanced)", and then click [Next].

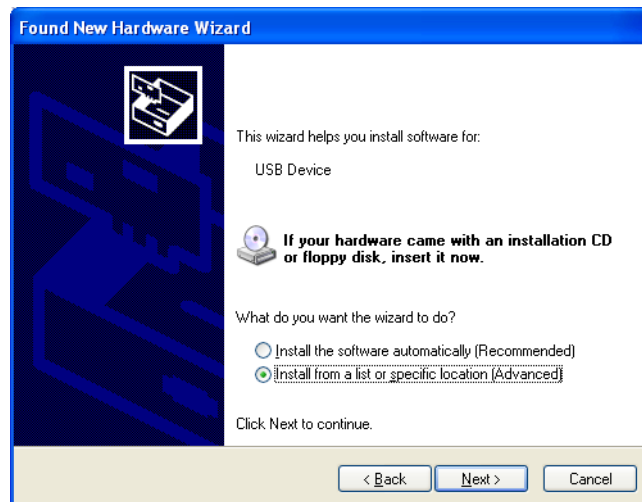

- 6 Select the "Include this location in the search" check box, check that the application CD-ROM appears as a location to be searched, and then click [Next].



- If the application CD-ROM does not appear as a location to be searched for the driver, click [Browse], select the IC Card Driver (USB-Driver) folder on the CD-ROM, and then click [OK].



The installation begins.

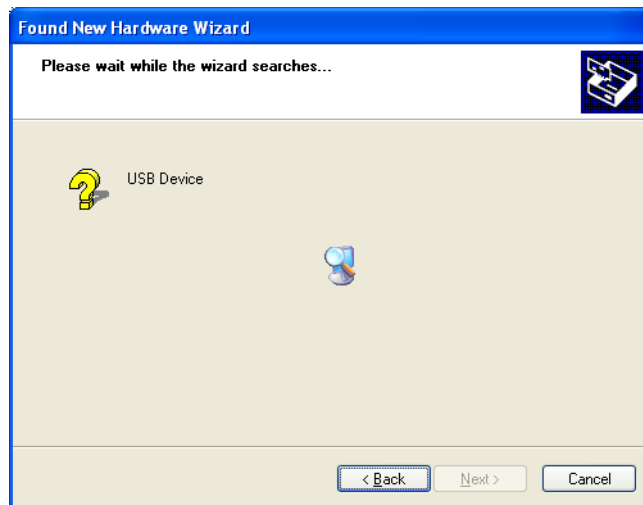

- 7 Click [Finish].

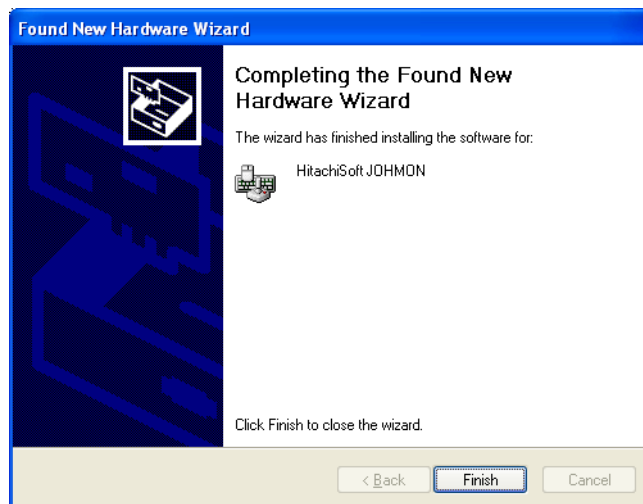

The installation of IC Card Driver (USB-Driver) is completed.

- 8 Install Data Administrator IC Card Plugin.
Open the IC_Card_Plugin folder on the application CD-ROM, and then click "setup.exe".

- 9 Select the language, and then click [OK].

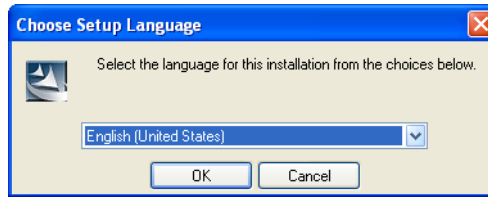

The installer starts up.

- 10 Follow the instructions that appear on the screen to complete the installation.
- 11 Click [Next].



- 12 Select "I accept the terms of the license agreement", and then click [Next].



13 Click [Install].

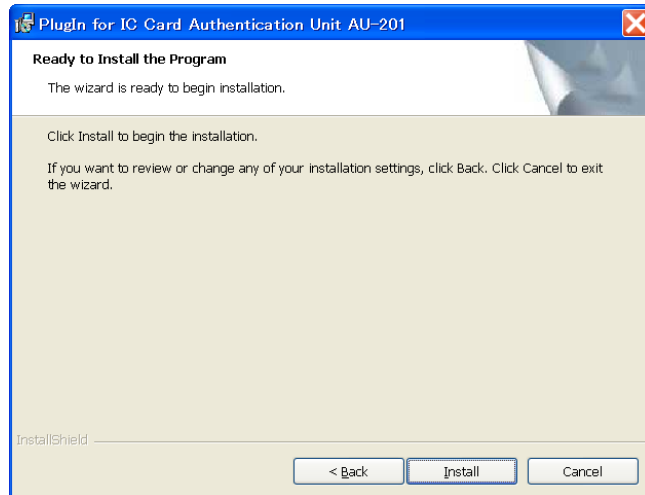

14 Click [Finish].

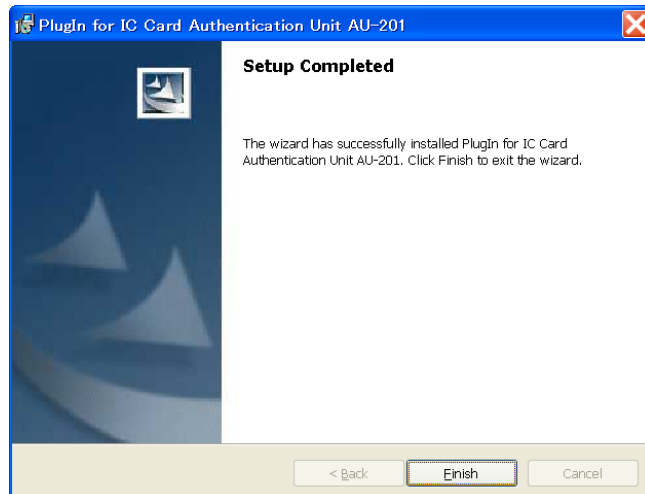

Data Administrator IC Card Plugin is installed, and the setup is completed.

Registering users



Reminder

In order to register users with Data Administrator, the authentication unit must be connected to the USB port of the computer, and the computer and machine must be connected over a network.

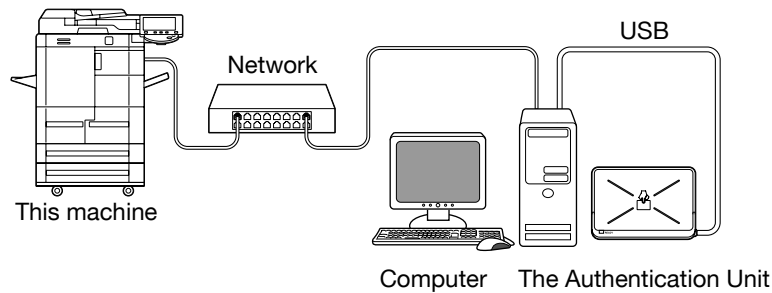

- 1 If the authentication unit is connected to this machine, turn off the machine with the main power switch, and then disconnect the authentication unit.
 - If the authentication unit is connected to the computer, continue with step 4.

- When the machine is turned off, then on again with the main power switch, wait at least 10 seconds to turn the machine on after turning it off. The machine may not operate correctly if it is turned on immediately after being turned off.
- Hold the plug when plugging and unplugging the USB cable, otherwise the cable may be damaged.

2 Turn on the machine with the main power switch.

3 Connect the authentication unit to the USB port of the computer installed with Data Administrator.

- Do not connect other USB devices to the same port where the authentication unit is connected. If enough USB power is not provided, Authentication Unit (IC Card Type) may not operate correctly.
- When using a USB hub, be sure to use a self-powered USB hub that can provide 500 mA or more.
- After connecting the authentication unit, wait at least 5 seconds before operating it.
- If the data have already been read out, proceed to 7.

4 Find this device in the window, then double-click it.

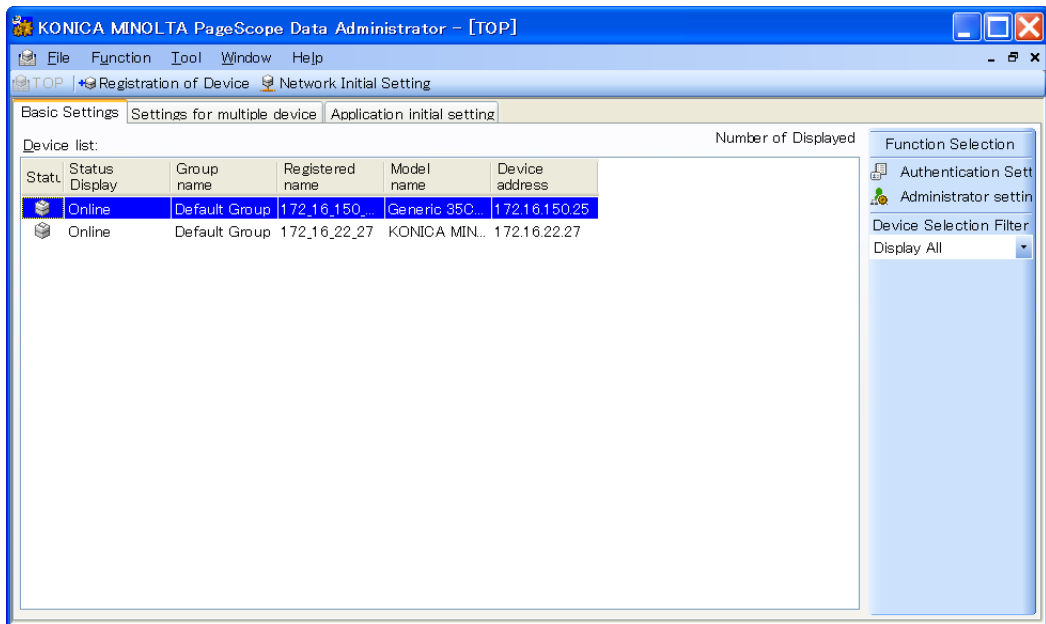

5 Click [Import].

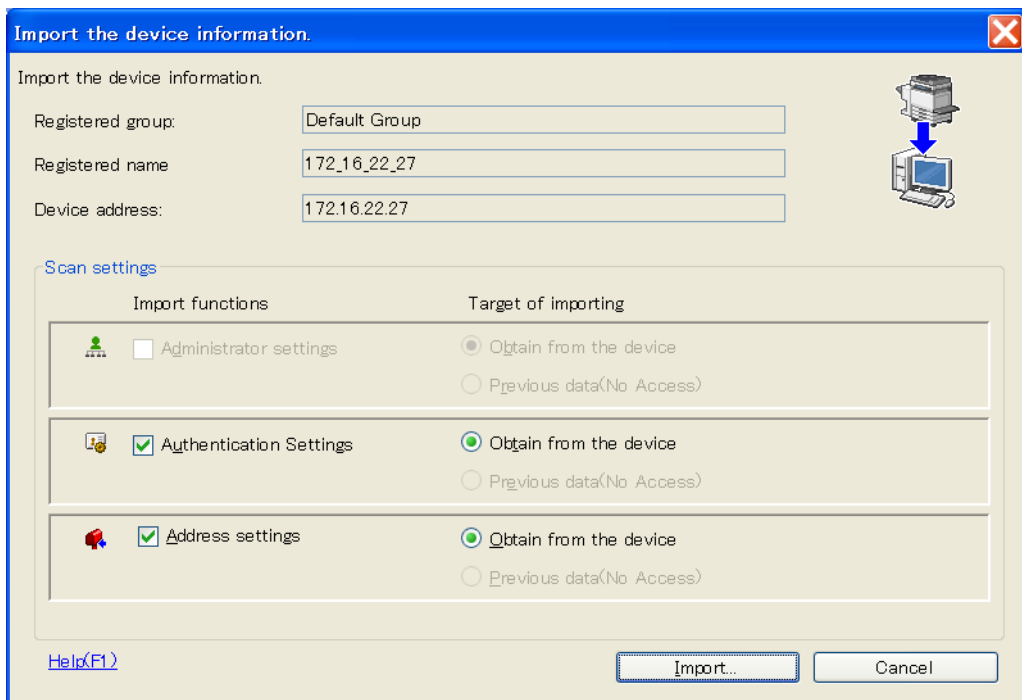

6 Click [Yes].

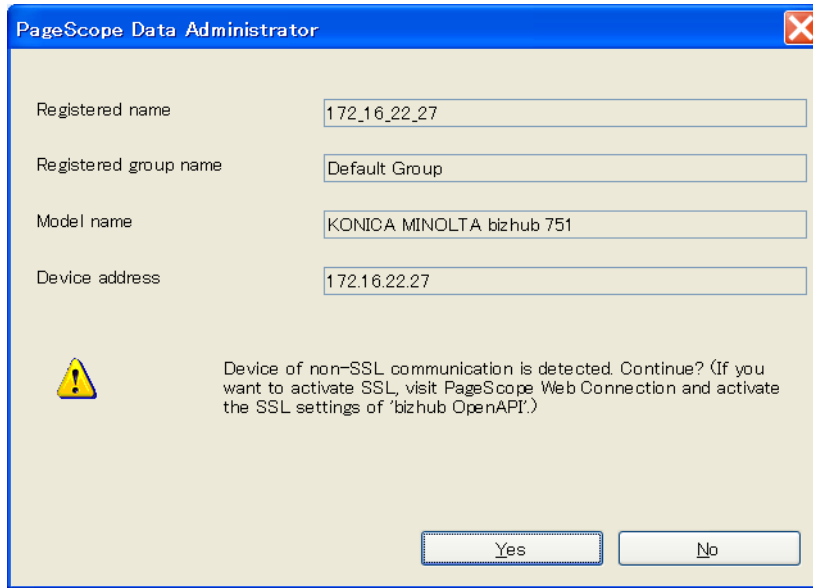

7 Start up Data Administrator, and then import the device information for this machine.
 – For details on importing the device information, refer to the User’s Guide for Data Administrator.

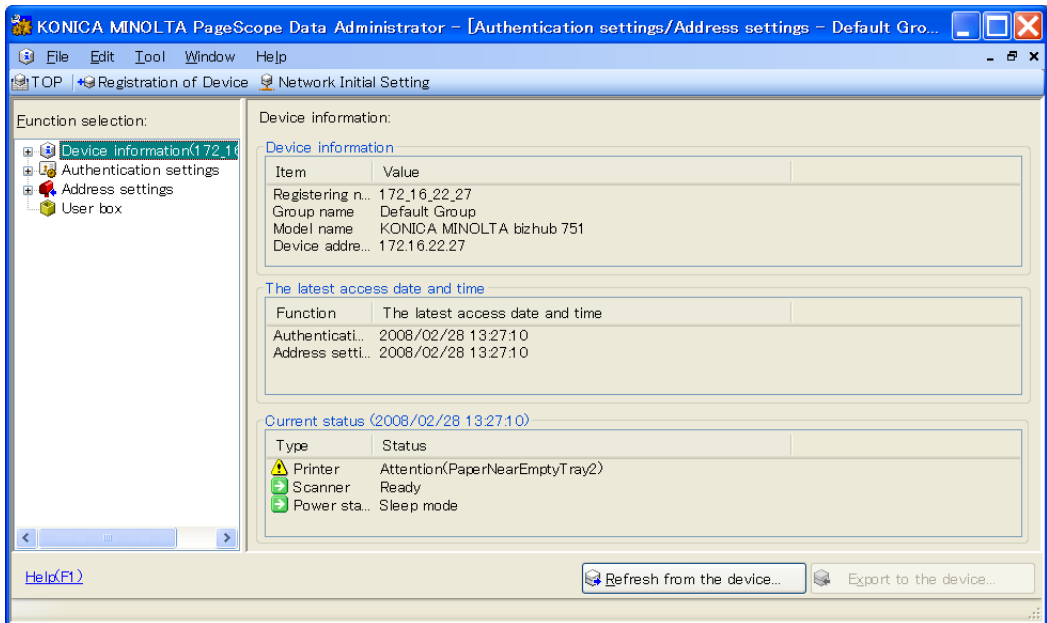

The Device information pane appears.

- 8 Select "User authentication settings" in the Function selection pane, and then click [Add].

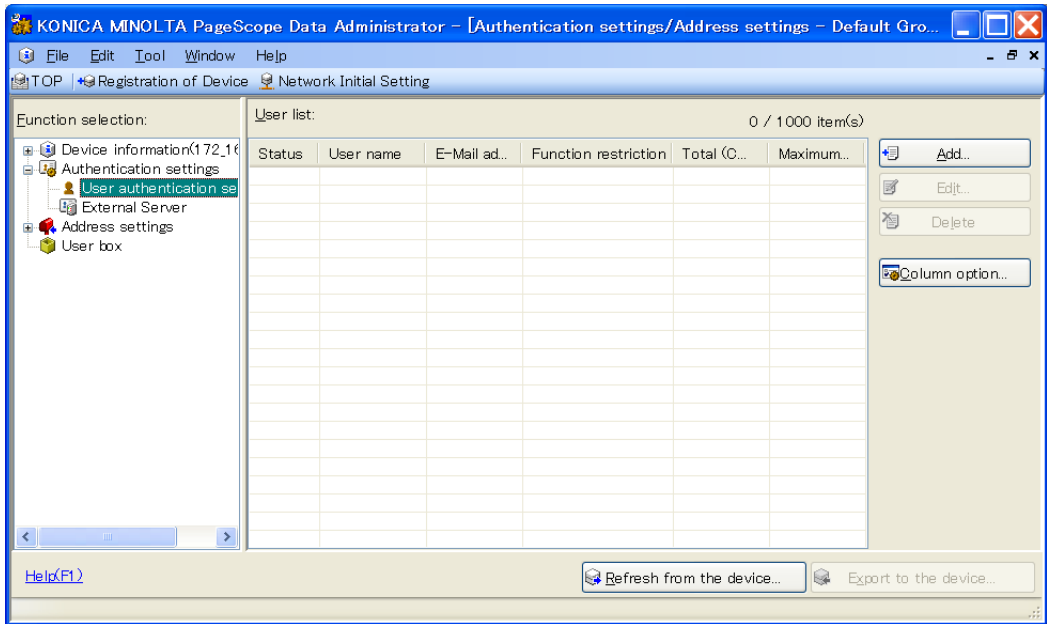

- 9 Select a template, and then click [OK].

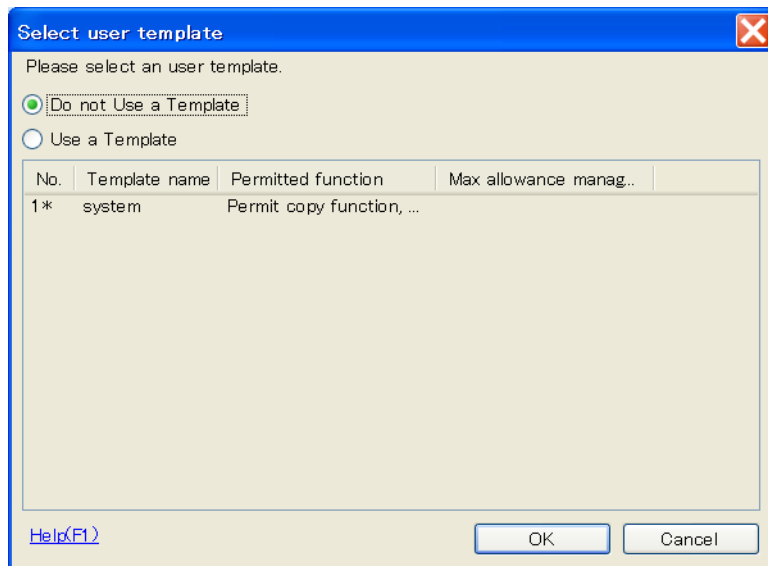

The User settings dialog box appears.

- 10 Type in the user name and password, click the IC card authentication tab.

- If desired, type in the e-mail address.

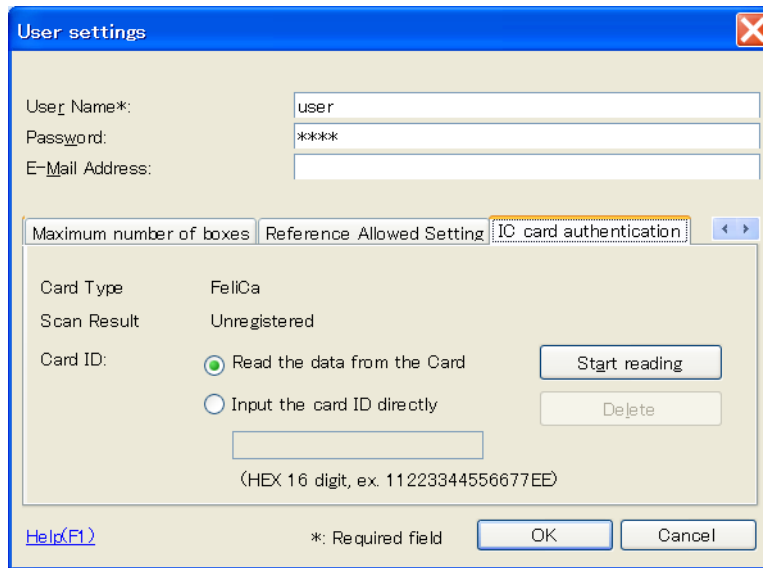

- 11 Position the IC card on the authentication unit, and then click [Start reading].
 - The card ID can also be registered by selecting "Input the card ID directly".
- 12 Click [OK].
 - Repeat steps 8 through 12 until all users have been registered.

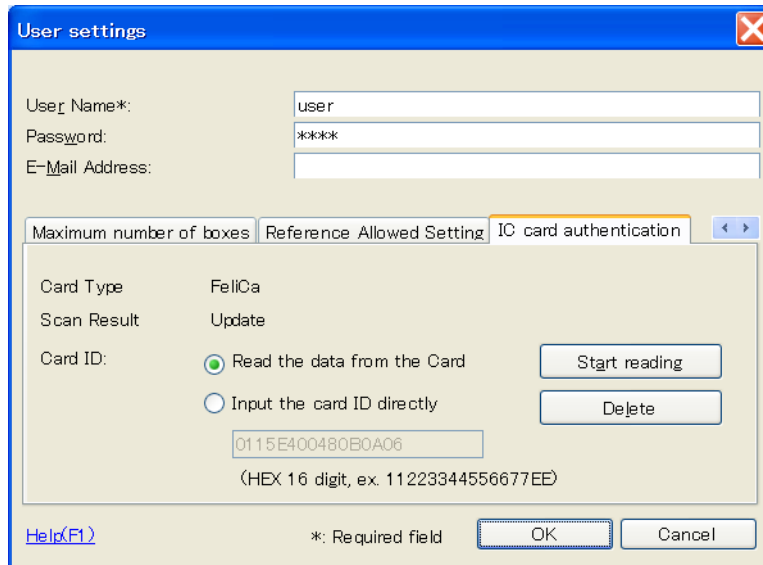

13 Click [Export to the device].

- To change the registered data, select the user name, and then click [Edit].

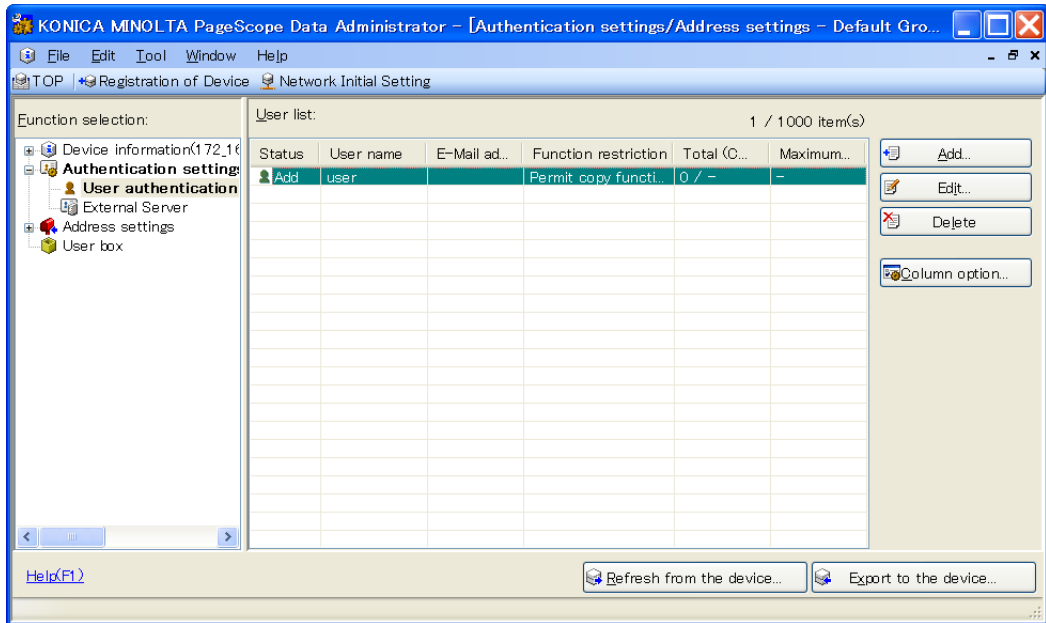
**14** Click [Write].

- Data Administrator is equipped with a batch copy feature that allows the registered user data to be specified on the multiple machines specified to be used with the authentication unit.

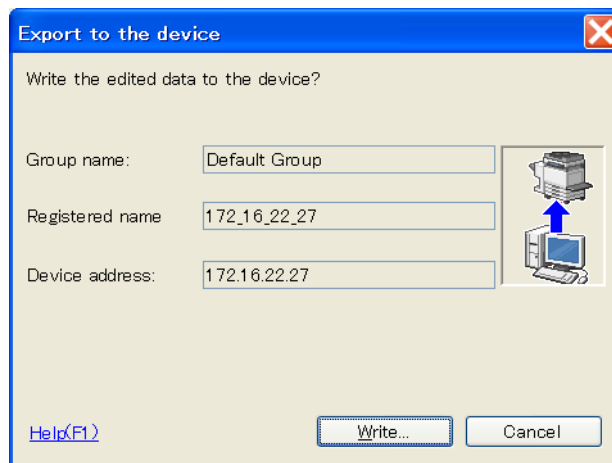

The registered user data is specified on the machine.

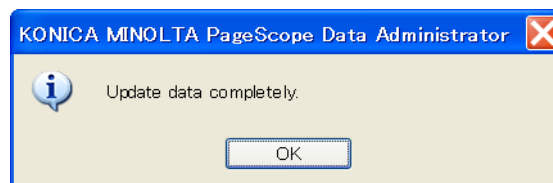
15 Click [OK].**16** Disconnect the authentication unit from this USB port of the computer.**17** Turn off the machine with the main power switch, connect the authentication unit, and then turn on the machine with the main power switch.

- When the this machine is turned off, then on again with the main power switch, wait at least 10 seconds to turn the machine on after turning it off. The machine may not operate correctly if it is turned on immediately after being turned off.
- Hold the plug when plugging and unplugging the USB cable, otherwise the cable may be damaged.

13.1.3 Logging on to this machine

Follow the procedures described below to log on to this machine by completing authentication with IC card IDs.

When "Card Authentication" has been specified" has been specified

- 1 Position the registered IC card on the authentication unit.



- 2 The user is authenticated, and the Basic screen appears.

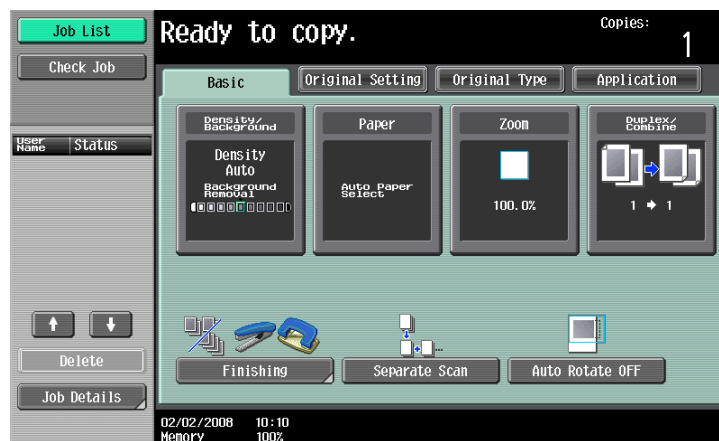

When "Card Authentication + Password" has been specified

- 1 Position the registered IC card on the authentication unit, and then type in the password.



- 2 Touch [Login] or press the [Access] key.

The user is authenticated, and the Basic screen appears.

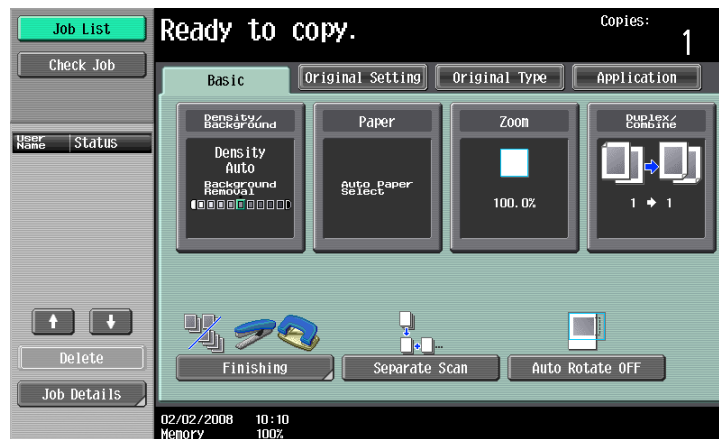

...

Note

The notification beep sounds while scanning. The notification beep is canceled by touching [Login] or pressing the [Access] key to complete authentication. This is a normal operation of the device.

If authentication fails many times, the authentication data may not be registered correctly. Therefore, register the user again.

13.1.4 Touch & Print function

Print jobs sent from a computer are saved in the Touch & Print user box on this machine and can be printed after authentication is completed with IC card IDs. This is called the Touch & Print function.

In addition, documents saved in the Touch & Print user box can be checked and specified to be printed from the control panel of this machine.

The following printer drivers and computer operating systems are compatible with the Touch & Print function

Printer driver	Page description language	Supported operating systems
PCL Driver	PCL6	Windows NT 4.0 (Service Pack 6a), Windows 2000 Professional (Service Pack 4 or later), Windows XP Home Edition/Professional (Service Pack 2 or later), Windows XP Professional x64, Windows Server 2003, and Windows Server 2003 x64
PostScript Driver (PS driver)	PostScript3 Emulation	Windows 2000 Professional (Service Pack 4 or later), Windows XP Home Edition/Professional (Service Pack 2 or later), Windows XP Professional x64, Windows Server 2003, and Windows Server 2003 x64
PostScript PPD driver (PS-PPD)		Mac OS X 10.2, Mac OS X 10.3, and Mac OS X 10.4



Detail

To use the Touch & Print function, select "Card Authentication" under "Operation Settings" and set "Touch & Print Setting" to "ON".



Note

For details on the printer driver settings and Box mode functions, refer to the User's Guide included with this machine.

Touch & Print (For Windows)

-Specifying settings on the Configure tab

- 1 For Windows 2000/NT 4.0, click the [Start] button, point to "Settings", and then click "Printers".
For Windows XP/Server 2003, click the [Start] button, and then click "Printers and Faxes".
For Windows Vista, click the [Start] button, and then click "Control Panel", then "Hardware and Sound", then "Printers".
 - If "Printers and Faxes" does not appear in the Start menu, open the Control Panel from the Start menu, select "Printers and Other Hardware", and then select "Printers and Faxes".
 - If Control Panel in Windows Vista is displayed in the Classic view, double-click "Printers".
- 2 Right-click the icon of the installed printer, and then click "Properties".

- 3 Click the Configure tab.

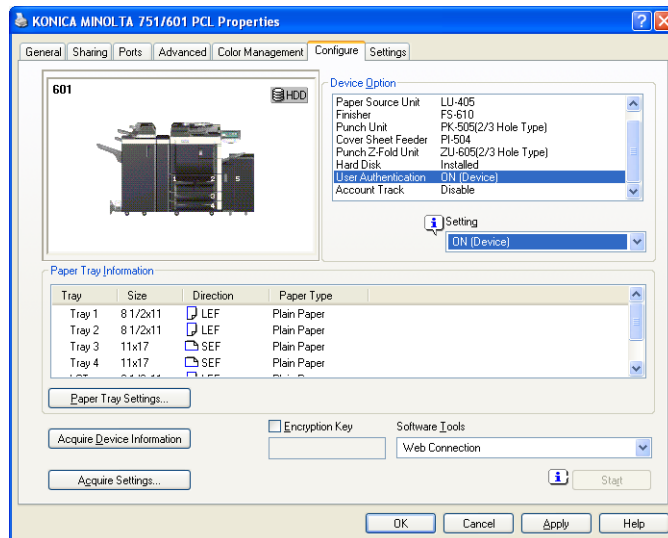

- 4 Select "User Authentication" under "Device Option".
- 5 Select "Device" from the "Setting" drop-down list.
- 6 Click [Apply], and then click [OK].

-Sending a print job

- 1 Open the data in the application, click [File], and then click [Print].
- 2 Check that the printer name has been selected in "Printer Name" or "Select Printer". If the printer is not selected, click to select the printer.
 - The Print dialog box differs depending on the application.

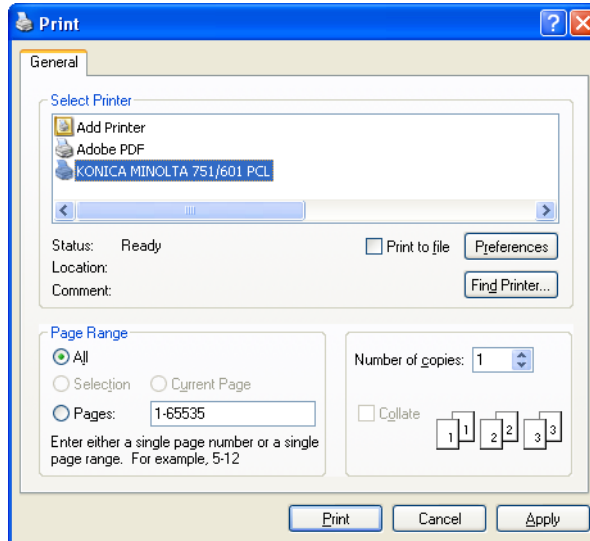

- 3 Click [Preferences] (or [Properties]).
- 4 Click the Basic tab.

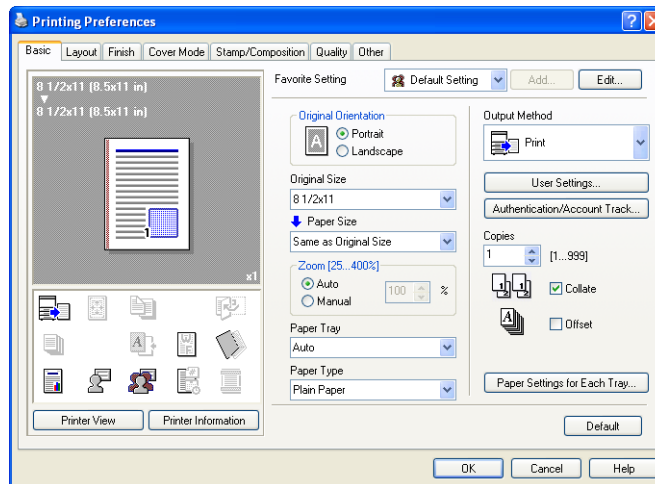

- 5 From the "Output Method" drop-down list, select "Print".
- 6 Click the [Authentication/Account Track] button.

- 7 Select "Recipient User", and then enter the user name and password.

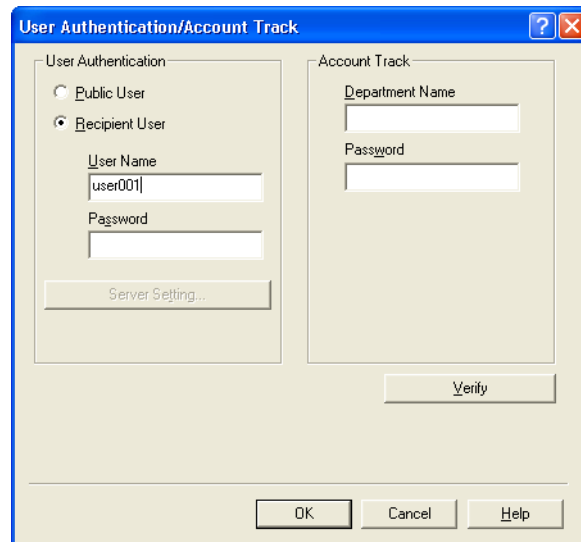

- 8 Click [Verify] to check the user ID.
- 9 Click [OK].
- If the user name or the password is incorrect, type in the correct information.

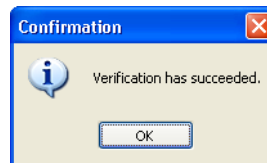

- 10 Click the [OK] button.
- 11 Specify the desired settings, and then click [OK].
- 12 Click [Print].
- The print job is sent.
- 13 Position the registered IC card on the authentication unit.

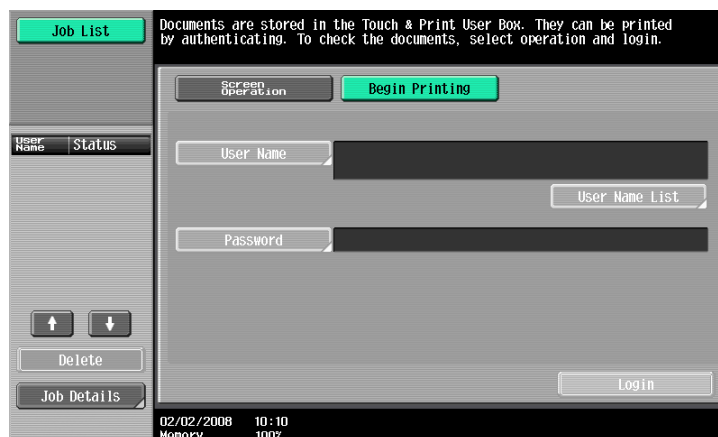

- Make sure that "Begin Printing" is selected.
- To select the print job to be printed, touch [Screen Operation]. For details, refer to ["Selecting the print job to be printed from the control panel" on page 13-24.](#)

The user is authenticated, and the print job is printed.

Touch & Print (for Macintosh)

-Sending a print job

- 1 Open the data in the application, click [File], and then click "Print".
- 2 Check that the printer name has been selected.
 - The Print dialog box differs depending on the application.

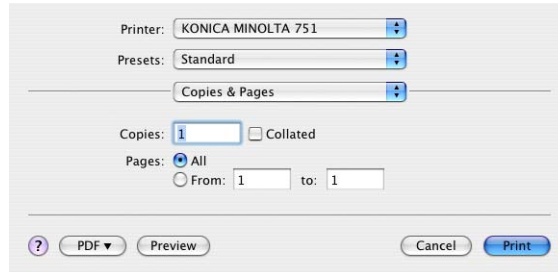

- 3 From the drop-down menu, select "Output Method".
- 4 From the "Output Method" drop-down list, select "Print".

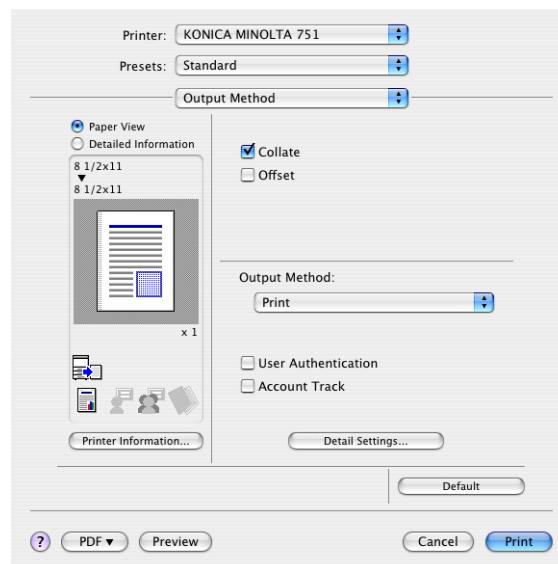

- 5 Select the "User Authentication" check box.
The User Authentication dialog box appears
- 6 Select "Recipient User", and then enter the user name and password.



- 7 Click the [OK] button.
- 8 Specify the desired settings, and then click [Print].
The print job is sent.
- 9 Position the registered IC card on the authentication unit.

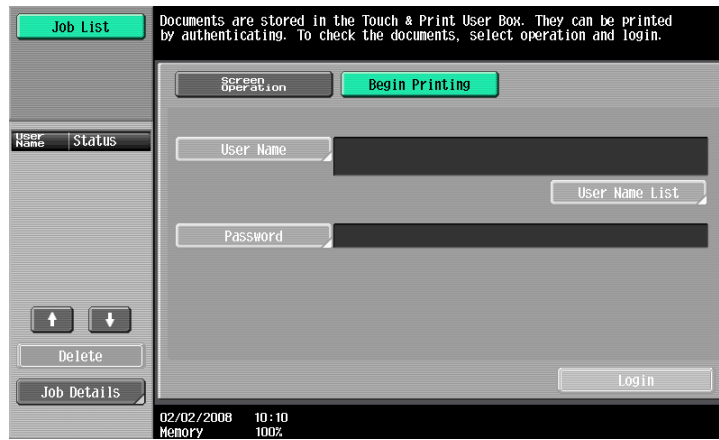

- Make sure that "Begin Printing" is selected.
- To select the print job to be printed, touch [Screen Operation]. For details, refer to ["Selecting the print job to be printed from the control panel" on page 13-24.](#)

The user is authenticated, and the print job is printed.

Selecting the print job to be printed from the control panel

Follow the procedure described below to select the document to be printed from those saved in the Touch & Print user box.

- 1 Touch [Screen Operation].

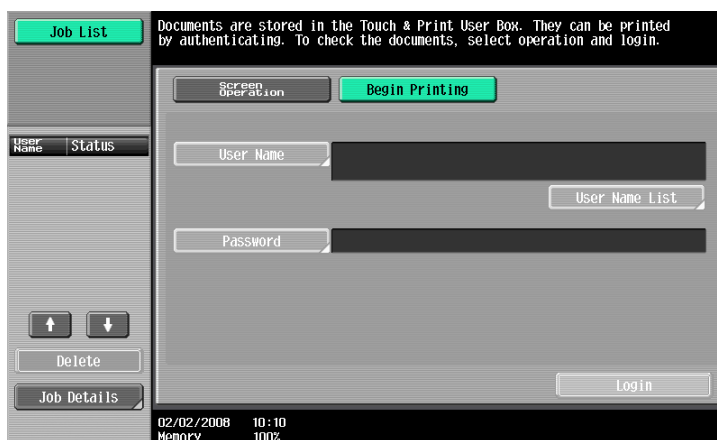

- 2 Position the registered IC card on the authentication unit.

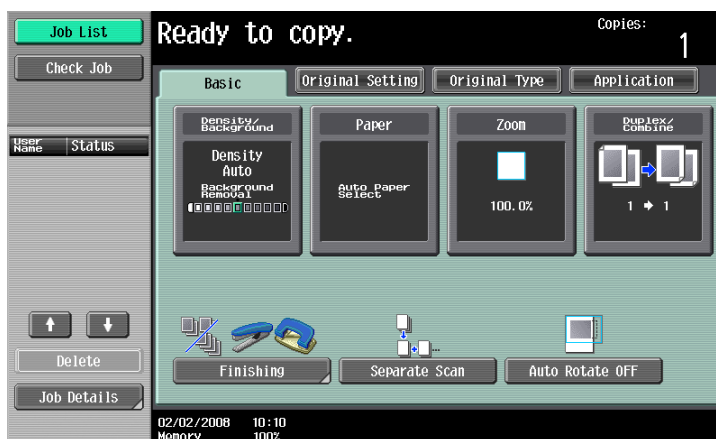

The user is authenticated, and the Basic screen appears.

- 3 Press the [User Box] key in the control panel.

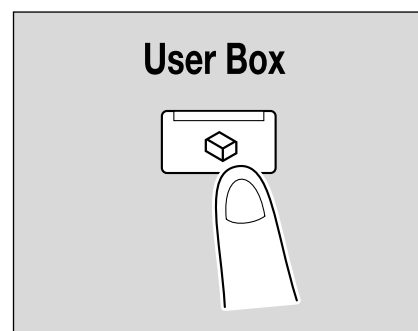

4 Touch [Use Document].



5 Touch [System User Box].

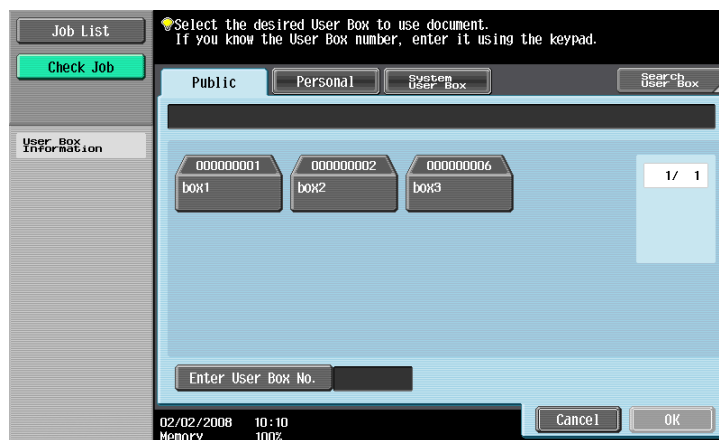

6 Touch [Touch & Print User Box], and then touch [OK].

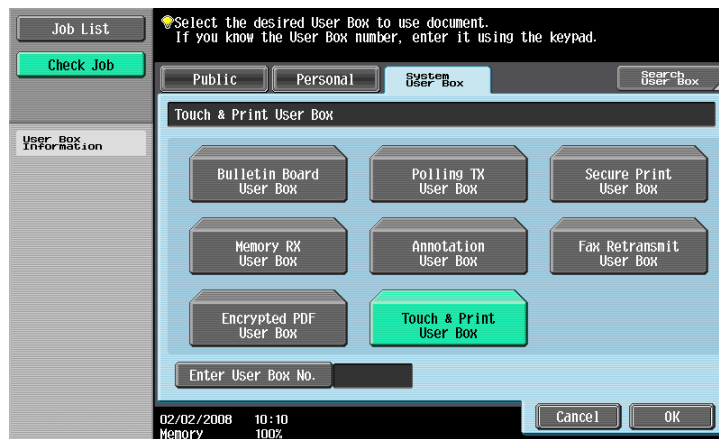

7 Select the document to be printed.

- Multiple documents can be selected.
- To select all documents, touch [Select All].
- To cancel the selection of all documents, touch [Reset].

- To check various information, such as the date/time when the document was stored and the document name, touch [Detail View].

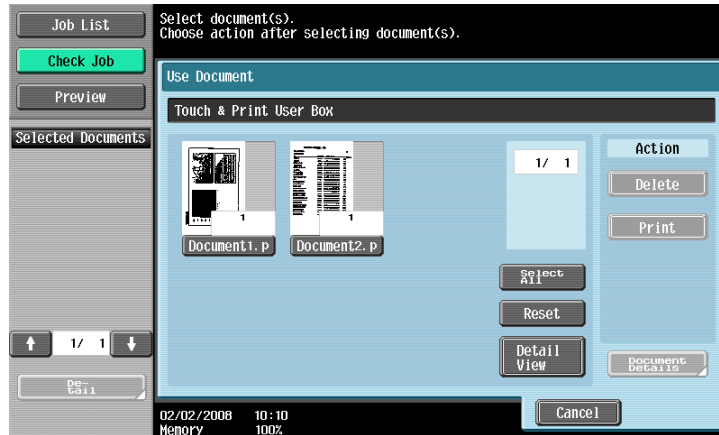

- 8 Touch [Print] under "Action", and then touch [OK].
 - To delete the document, touch [Delete].
 - To check the document details, touch [Document Details].
 - To cancel the operation, touch [Cancel].The selected document is printed.

**Note**

If authentication fails many times, the authentication data may not be registered correctly. Therefore, register the user again.

14

Appendix

14 Appendix

14.1 Entering text

The following procedure describes how to use the keyboard that appears in the touch panel for typing in the names of registered users and custom paper sizes. The keypad can also be used to type in numbers.

Any of the following keyboards may appear.

Example

Password input screen:



Screen for entering the name of a custom paper size:



Touching [Shift] switches the keyboard display between lowercase letters (numbers) and uppercase letters (symbols).

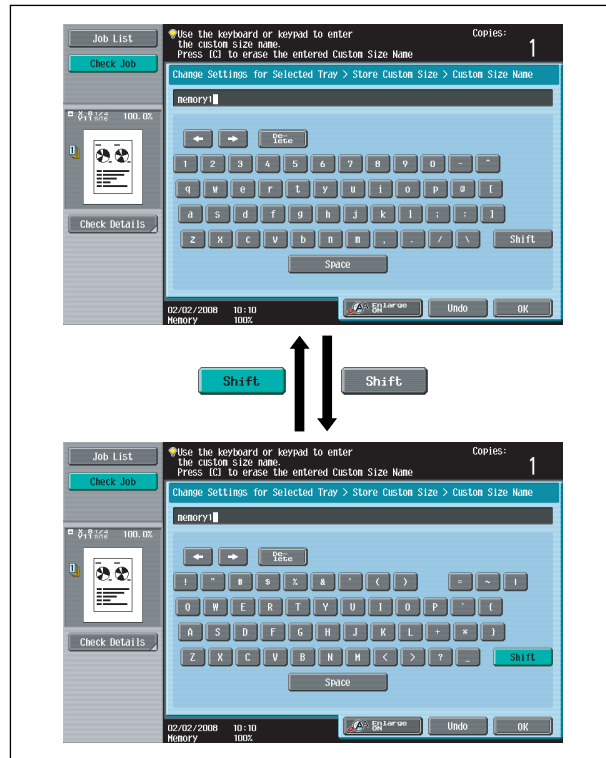

14.1.1 Enlarging the keyboard

The keyboard can be displayed larger so that it is easier to read.

- 1 While the keyboard is displayed, touch [Enlarge ON].
The keyboard is displayed enlarged.



- 2 To cancel the enlarged display and return the keyboard to its normal size, touch [Enlarge OFF] while the keyboard is displayed enlarged.



Note

The keyboard is used in the same way, even when it is displayed enlarged.

14.1.2 To type text

- Touch the button for the desired character from the keyboard that appeared.
 - To type in uppercase letters or symbols, touch [Shift].
 - Numbers can also be typed in with the keypad.
- The entered characters appear in the text box.



Note

To revert to the setting when the keyboard was displayed, touch [Cancel].

To clear all entered text, press the [C] (clear) key.

Some buttons may not appear, depending on the characters being entered.



Detail

To change a character in the entered text, touch [←] and [→] to move the cursor to the character to be changed, touch [Delete], and then type in the desired letter or number.

14.1.3 List of Available Characters

Alphanumeric characters/symbols	ABCDEFGHIJKLMNOPQRSTUVWXYZabcdefghijklmnopqrstuvwxyz [space]!"#\$%&'()*+,-./\:;<=>?@[^_`{ }~*0123456789
---------------------------------	--

14.2 Glossary

The words used in Copy mode are described below.

Abbreviation

ADF

Automatic document feeder; Can be used to automatically scan the original

ADU

Automatic duplex unit; used to print automatically on both sides of paper.

APS

"Auto Paper Select" setting

ATS

Automatic paper-tray-switching feature (ATS = Auto Tray Switch)

LCT

Large capacity tray; can be loaded with a large amount of paper to feed it into the copier main body.

A

Auto Zoom

Select this setting to automatically select the appropriate zoom ratio after an original is placed on the original glass or loaded into the ADF and the paper size is selected.

Auto Paper Select

Select this setting to detect the original placed on the original glass or loaded into the ADF, then automatically select paper of the same size if "x1.0" is selected or select the paper size appropriate for the specified zoom ratio.

B

Background Removal

Select a setting to adjust the density of the background color of the original to one of nine levels.

C

Change Tray Settings

Touch this button to specify a paper size or type not loaded in a paper tray or to copy on paper other than normal paper.

Chapters

Set this function to specify chapter title pages that must be printed on the front side of the paper when printing double-sided copies.

Combine

Select a setting to arrange reduced copies of multiple original pages on a single copy page. The settings for the number of pages that can be combined are "2 in 1", "4 in 1" and "8 in 1".

Cover Mode

Set this function to add paper from the specified paper tray to the copies as a cover page.

D

Density

Select a setting to adjust the density of the print image to one of nine levels.

Duplex

Select the setting to specify if the scanned original and the printed copy are printed on just one side or both sides.

F

Fold & Staple

Set this function to fold the copies in half and staple them together at the center.

Finishing

Select from the settings that are available for sorting and finishing copies when they are fed into the finishing tray.

G

Group (Copy/Finishing)

Select this setting to separate the copies of each page in the original. The specified number of copies of the second page is printed after all copies of the first page are finished.

Group (reference permission)

Use this feature to limit the addresses that each user can reference and to manage security.

I**Insert Image**

Set this function to later scan multiple images from the original glass and insert them at the desired locations in an original scanned with the ADF, then feed out all copies together.

Insert Sheet

Set this function to insert paper from the specified paper tray into the copies as chapter title pages.

M**Margin**

Select the setting for the position of the binding margin for the loaded original. Selecting the appropriate setting prevents the copy from being printed upside-down when making double-sided copies from single-sided original or when making single-sided copies from double-sided originals.

Minimal

Select this setting to produce a copy with the original image slightly reduced.

Mixed Original

Select this setting to detect the size of each original page and print a copy on paper of the appropriate size when an original with different page sizes is loaded together into the ADF.

N**Neg-/Pos. Reverse**

Set this function to copy the original with the light- and dark-colored areas or the colors (gradations) of the image inversed.

O**Offset**

Select this setting to separate copies that are fed out.

OHP Interleave

Set this function to insert paper between OHP that are being copied. This prevents OHP from sticking together.

Original Type

Select the setting for the image type of the original to better adjust the copy quality.

Original Direction

Select the setting for the orientation that the original is placed on the original glass or loaded into the ADF.

P**Paper**

Select settings for the type and size of paper to be printed on.

Proof Copy

Press this key to print a single sample copy and stop the machine so that it can be checked before printing a large number of copies. This prevents copy errors from occurring in a large number of copies.

Punch

Select the setting to punch holes in the copies for filing.

S**Save in User Box**

Temporarily saves the job on the hard disk so that it can later be recalled and used again

Separate Scan

Scans an original exceeding the maximum 80 pages that can be loaded into the ADF by scanning the original in separate batches. The original can be scanned and treated as a single copy job. In addition, the scanning location can be switched between the original glass and the ADF during the scanning operation.

Sheet/Cover/Chapter Insert

Select from the functions that are available to edit copies as desired

Sort

Select this setting to separate each set of the copies. The second copy set is printed after all of the first copy set is finished.

Staple

Select a setting to staple copies together.

X

XY Zoom

Touch this button to use the keypad to specify the zoom ratio for producing an enlarged/reduced copy of the loaded original.

Z

Zoom

Specify the zoom ratio of the copy.

15

Index

15 Index

15.1 Index

Symbols

[Power] (auxiliary power) key 1-29

Numerics

1st Z-Fold Position Adjustment/2nd Z-Fold
Position Adjustment 11-49
2in1 2-47
2-Position Staple Pitch Adjustment 11-53
4in1 2-47
8in1 2-47

A

Accessibility 3-18
Account track 1-38
Account Track Settings 11-72
ADF 2-6, 6-29, 14-5
Administrator Settings 11-23
Administrator/Machine Setting 11-28
Authentication method 11-59
Authentication unit 1-41, 1-44
Authentication unit (biometric type) 1-41
Authentication unit (IC card type) 1-44
Auto Paper setting 2-30
Auto Reset Confirmation 3-22
Auto Zoom setting 2-32
Automatic panel reset 1-31

B

Background Removal 2-52, 2-53
Basic screen 1-24
Binding Position 2-24
Biometric authentication 1-41
Book Copy 7-24
Booklet 7-42
Bypass tray 1-5, 1-53

C

Call service representative 4-2
Center Staple & Fold 2-65, 2-67
Center Staple Position 11-39
Chapters 7-15
Check Job 3-2
Cleaning 9-2
Combined pages 2-47
Conserving energy 1-32, 1-33, 1-34
Consumables 8-2
Control panel 1-22, 1-27
Copier Settings 11-18, 11-32
Cover Sheet 7-5
Create One-Touch Destination 11-7
Create User Box 11-7

Current Jobs list 10-9
Custom Display Settings 11-17
Custom Size settings 6-14, 6-24

D

Deleting jobs 10-6
Density 2-52
Destination registration 11-7, 11-29
Double-sided copying 2-44

E

Emptying hole-punch scrap boxes 8-18
Enlarge Display Mode Confirmation 3-24
Enlarge/Reduce settings 2-36
Entering text 14-2
Erase 7-45, 7-46, 7-47, 7-50

F

Face UP 2-54, 2-59
Fax Settings 11-33
Fax/Scan Settings 11-20
Features x-9
Finisher FS-524 1-11
Finisher FS-525 1-13
Finisher FS-610 1-15
Finishing 2-54
Folding 2-65
Full Size 2-33
Fusing unit 1-8

G

Glossary 14-5
Glossy 2-52
Group 2-54, 2-56

H

Half-Fold 2-65
Half-Fold Position 11-40
Header/Footer 11-56
Help 3-13

I

IC card authentication 1-44
Icons 1-26
Image Adjustment 7-39
Image Repeat 7-29
Increase Priority 10-14
Individual Zoom 2-37
Insert Image 7-12
Insert Sheet 7-8
Internal 1-7
Interrupt 3-7

- J**
- Job History list 10-9
 - Job List screen 10-2
- K**
- Key Repeat Start/Interval Time 3-19
- L**
- Large Capacity Unit LU-405 1-9
 - Large Capacity Unit LU-406 1-10
 - Left panel Job List 10-5
 - Lever M4 1-58
 - Limiting Access to Destinations 11-7
 - Loading paper 1-47, 1-48, 1-50, 1-53
 - Low power mode 1-32
- M**
- Machine Configuration 1-2
 - Main messages and their remedies 4-47
 - Main power switch 1-29
 - Message 9-7
 - Message Display Time 3-26
 - Meter Count 9-6
 - Minimal 2-35
 - Mixed Original 2-18, 14-6
 - Mode Memory 3-8, 3-11
- N**
- Neg./Pos. Reverse 7-22
 - Network Setting 11-31
 - Non-standard-sized paper 6-12
- O**
- Offset 2-54
 - OHP Interleave 7-2
 - One-Touch Destination/User Box
Registration 11-29
 - Options 1-2
 - Original > Copy settings 2-42
 - Original Direction 2-22, 14-6
 - Original feeding 2-6
 - Original glass 2-7
 - Original orientation x-17
 - Original Type 2-50, 14-6
 - Originals 6-29
 - Output Tray OT-505 1-21
 - Oversized paper 6-16
 - Oversized paper settings 6-25
- P**
- Page Margin 7-36
 - Paper misfeed 4-4
 - Paper misfeed indications 4-5
 - Paper storage 6-7
 - Paper take-up roller 1-47
 - Password Rules 11-76
 - Periodic maintenance 9-7
 - Post Inserter PI-504 1-19, 2-73, 4-38
 - Post Inserter Tray Size Adjustment 11-54
 - Power save 1-32, 1-33
 - Printer Settings 11-20, 11-32
 - Program Jobs 7-18
 - Proof Copy 3-5
 - Punch Horizontal Position Adjustment 11-45
 - Punch Kit PK-505 1-11, 1-13, 1-14, 1-15
 - Punch Resist Loop Adjustment 11-48
 - Punch settings 2-54, 2-62
 - Punch Unit Horizontal Position Adjustment 11-47
 - Punch Unit Vertical Position Adjustment 11-44
 - Punch Vertical Position Adjustment 11-42
- Q**
- Queuing copy jobs 2-77
 - Quick copy screen 1-24
- R**
- Recall Copy Program 3-11
 - Replacing the staple cartridge 8-6
- S**
- Save in User Box 7-77
 - Security Settings 11-33
 - Selecting the output tray 2-58
 - Separate Scan 2-8
 - Set Zoom 2-40
 - Shift Tray SF-602 1-20
 - Simple troubleshooting 4-43
 - Single-sided copying 2-43
 - Sleep mode 1-33
 - Sort 2-54, 2-56
 - Sound Setting 3-27
 - Special Size settings 6-22
 - Stamp/Composition 7-51
 - Standard Size 1 settings 6-21
 - staple cartridge 8-6
 - Staple settings 2-54, 2-60
 - Stored jobs 10-11, 10-12
 - System Auto Reset 1-32
 - System Auto Reset Confirmation 3-21
 - System Connection 11-33
 - System Settings 11-15, 11-23
- T**
- Tab Original Settings 2-21
 - Temporarily stopping 2-78
 - Text Enhancement 2-52
 - Text entry 14-2
 - Toner cartridge 8-2
 - Touch panel 1-24, 3-18
 - Transport lever 1-58
 - Tray 1 1-4, 1-47
 - Tray 2 1-4, 1-47
 - Tray 3 1-4, 1-48
 - Tray 4 1-4, 1-48
 - Tri-Fold 2-65, 2-68

Tri-Fold Position Adjustment	11-51
Trouble code	4-2
Trouble shooting	4-2
U	
User authentication	1-35
User Authentication Setting	11-64
User Authentication/Account Track	11-29
User Settings	11-15
User's guide conventions	x-15
User's guides	x-18
Utility mode	11-2
W	
Warm-up	1-30
Weekly timer	1-34, 11-38
Wide Paper settings	6-16
X	
XY Zoom	2-33
Z	
Z Folding Unit ZU-605	1-18
Z-Fold	2-65, 2-70
Z-Folded Original	2-20



KONICA MINOLTA

<http://konicaminolta.com>